



DP9D / DP13D / DP14D - 40' / 60'
OWNERS MANUAL DRY DURAPLACER
OWNERS MANUAL – 2023





Table of Contents

Section	Page
Table of Contents	i
Warranty Registration	vii
<i>Warranty Inspection Report</i>	<i>vii</i>
Inspections	ix
<i>Pre-Delivery</i>	<i>ix</i>
<i>Delivery</i>	<i>x</i>
<i>After-Sale</i>	<i>xi</i>
Owner Register	xii
Foreword to the Owner	xiii
INTRODUCTION	1
SAFETY	2
<i>Safety Alert Symbols and Signal Words</i>	<i>2</i>
<i>General Safety</i>	<i>3</i>
Prepare for Emergencies	<i>3</i>
Wear Protective Clothing	<i>3</i>
Protect Against Noise	<i>3</i>
Practice Safe Maintenance	<i>3</i>
Support Raised Equipment	<i>4</i>
Avoid Heating Near Pressurized Fluid Lines	<i>4</i>
Avoid High-Pressure Fluids	<i>4</i>
Inspect Lift Circuit Hoses	<i>5</i>
Store Attachments Safely	<i>5</i>
Electrical	<i>5</i>
Service Tires Safely	<i>5</i>
Dispose of Waste Properly	<i>6</i>
Handle Agricultural Chemicals Safely	<i>6</i>
Reduce risk of exposure and injury:	<i>6</i>
Handle Chemical Products Safely	<i>7</i>
Operate Hydraulics Safely	<i>7</i>
Use Safety Lights and Devices	<i>8</i>
Keep Riders Off Machine	<i>8</i>
Observe Maximum Transport Speed	<i>8</i>
EC Compliance Notification	<i>9</i>
Use a Signal Person	<i>9</i>
Use a Safety Chain	<i>9</i>
Tow Loads Safely	<i>9</i>



Avoid Overhead Power Lines	10
Prepare for Transport.....	10
Transport Safely	11
Park Safely.....	11
<i>Replace Safety Signs.....</i>	<i>12</i>
Hitch.....	12
Wing.....	13
Main Frame	14
Wheel and Tracks	14
<i>Safety Features.....</i>	<i>15</i>
<i>Sign-Off Form</i>	<i>16</i>
SPECIFICATIONS	17
<i>Tractor Power, Size Recommendation</i>	<i>17</i>
<i>Hydraulic System Requirements</i>	<i>17</i>
<i>Machine Dimensions & Specifications.....</i>	<i>18</i>
PREPARING THE MACHINE	19
<i>Use the Tractor Operator’s Manual.....</i>	<i>19</i>
<i>Pre-Operation Checklist.....</i>	<i>19</i>
AXLES, TIRES, and TRACKS	20
<i>Setting Axle Width.....</i>	<i>20</i>
Axle Width Chart – Singles	21
Axle Width Chart – Tracks	22
<i>Checking Tire Pressure</i>	<i>23</i>
<i>Checking Wheel Nuts</i>	<i>23</i>
<i>Track Use</i>	<i>24</i>
General Guidelines.....	24
Maximizing Track Life	24
Track System Break-In	25
<i>Track Wear & Trash Buildup.....</i>	<i>26</i>
<i>Undercarriage Inspection and Maintenance.....</i>	<i>26</i>
<i>Track Service.....</i>	<i>27</i>
Mid-Wheel, Wedges, Idler, and Mid-Roller Cap Screws.....	27
Check Track Alignment.....	28
Track Alignment Procedure.....	29
ATTACHING and DETACHING	30
<i>Attach the Machine Safely.....</i>	<i>30</i>
<i>Attach the Machine to the Tractor</i>	<i>30</i>
<i>Attach Safety Chain to Tractor.....</i>	<i>31</i>



<i>Attach Warning Light Plug</i>	31
<i>Connect Rate Controller or Nutrient Applicator System Wiring</i>	31
<i>Make Proper Hose Connections</i>	32
<i>SCV Identification Chart</i>	33
<i>Detach Machine from Tractor</i>	34
<i>Adjust Hitch Height</i>	34
TRANSPORTING	35
<i>Following Safe Transport Procedures</i>	35
<i>Preparing the Machine for Transport</i>	35
<i>Fold Toolbar for Transport</i>	35
<i>Transport Notes and Checks</i>	36
<i>Transporting the Machine</i>	36
<i>Using Warning Lights</i>	36
<i>Keep Riders Off the Machine</i>	36
<i>Caution for All Machines</i>	37
<i>Unfolding/Extending the Toolbar</i>	37
HYDRAULIC FLOW	39
<i>Regulating Hydraulic Flow to the Pump</i>	39
<i>Load Sensing Closed Center System (LS Closed)</i>	39
<i>Pressure Compensating Closed-Center System (PC Closed)</i>	39
<i>Open Center System (Open)</i>	40
<i>Tractor SCV Functions</i>	40
<i>Down Pressure (Kick) Orifice Adjustment</i>	42
ADJUST DEPTH CONTROL	43
<i>Adjust Application Depth</i>	43
<i>Adjust Gauge Wheels</i>	43
<i>Adjust Row Unit Height</i>	43
ADJUST GROUND SPEED	44
PREPARING THE HOPPER SYSTEM	45
<i>Manufacturer-specific Documentation</i>	45
<i>Prepare the Tank</i>	45
FILLING THE HOPPER TANK (BIN)	46
<i>Filling the Tank</i>	46
<i>Air Pressure Adjustment</i>	47
LUBRICATION and MAINTENANCE	48



<i>Lubricating and Maintaining the Machine Safely</i>	48
<i>Lubricant Storage</i>	48
<i>Grease</i>	48
<i>Greases for Air Temperature Ranges</i>	48
<i>Alternative and Synthetic Lubricants</i>	48
<i>Lubrication and Maintenance Intervals</i>	49
<i>Each 10 hours or Daily</i>	49
<i>Each 50 Hours or Weekly</i>	50
<i>Before and After Each Season</i>	50
<i>As Required</i>	50
SERVICE	51
<i>Practice Safe Maintenance</i>	51
<i>Work in a Clean Area</i>	51
<i>Service Machines Safely</i>	51
<i>Support the Machine Properly</i>	52
<i>Avoid High-Pressure Fluids</i>	52
<i>Preventing Hydraulic System Contamination</i>	52
<i>Replace Hydraulic Hoses</i>	53
<i>Tightening Hardware</i>	53
PREPARING FOR STORAGE	54
<i>Removing from Storage</i>	54
TIGHTENING HARDWARE	55
<i>Metric Bolt and Screw Torque Values</i>	55
<i>Unified Inch Bolt and Screw Torque Values</i>	56
<i>Face Seal Fittings Assembly & Installation - All Pressure Applications</i>	57
Face Seal O-Ring to Stud End Installation	57
Face Seal Adjustable Stud End O-Ring Installation.....	57
Face Seal Straight Stud End O-Ring Installation	57
Fitting Installation	57
Assembly Torque	57
<i>SAE Face Seal and O-Ring Stud End Fitting Torque Chart</i>	58





Limited Warranty

Fast Ag Solutions warrants to the buyer that the new machinery is free from defects in material and workmanship.

This warranty is only effective as to any new machinery which has not been altered, changed, repaired or treated since its delivery to the buyer, other than by Fast Ag Solutions or its authorized dealers or employees, and does not apply to accessories, attachments, tools or parts, sold or operated with the new machinery, if they have not been manufactured by Fast Ag Solutions.

Fast Ag Solutions shall only be liable for defects in the materials or workmanship attributable to faulty material or bad workmanship that can be proved by the buyer, and specifically excludes liability for repairs arising as a result of normal wear and tear of the new machinery or in any other manner whatsoever, and without limiting the generality of the foregoing, excludes application or installation of parts not completed in accordance with this Operator's Manual, specifications, or printed instructions.

Written notice shall be given by registered mail, to the Manufacturer within seven (7) days after the defect shall have become apparent or the repairs shall have become necessary, addressed as follows:

Fast Ag Solutions
4130 Commerce Boulevard
Windom, MN 56101

This warranty shall expire one (1) year after the date of delivery of the new machinery.

If these conditions are fulfilled, Fast Ag Solutions shall at its own cost and at its own option either repair or replace any defective parts provided that the buyer shall be responsible for all expenses incurred as a result of repairs, labor, parts, transportation or any other work, unless Fast Ag Solutions has authorized such expenses in advance.

The warranty shall not extend to any repairs, changes, alterations, or replacements made to the new equipment other than by Fast Ag Solutions or its authorized dealers or employees.

This warranty extends only to the original owner of the new equipment.

Rubber parts (including tires, hoses, grommets) are not warranted.

This warranty is limited to the terms stated herein and is in lieu of any other warranties whether express or implied, and without limiting the generality of the foregoing, excluded all warranties, express or implied or conditions whether statutory or otherwise as to quality and fitness for any purpose of the new equipment. The Manufacturer disclaims all liability for incidental or consequential damages.

This Dry DuraPlacer is subject to design changes and Fast Ag Solutions shall not be required to retrofit or exchange items on previously sold units except at its own option.

Warranty void if not registered.



FAST DRY DURAPLACER

Warranty Registration

This form must be filled out by the dealer and signed by both the dealer and the customer at the time of delivery.

Customer Name					
Address					
City		State		Zip	
Phone					

Dealer Name					
Address					
City		State		Zip	

DuraPlacer Model					
Serial Number					
Delivery Date					

Warranty Inspection Report

DEALER INSPECTION REPORT

- All Fasteners Tight
- Wheel Bolts Torqued
- Hydraulic Hoses and Fittings Free and Tight
- Fertilizer Hoses and Fittings Free and Tight
- Wheel Drive Turns Freely
- Lubricate Machine
- Check Tire Pressure
- Frame and Wings Level
- Monitors and Controllers Function
- Wiring Harness Connected

SAFETY

- Safety Chain Installed
- All Guards Installed
- All Safety Signs Installed
- Reflectors, SMV, and Lights Clean
- Review Operating and Safety Instructions

I have thoroughly instructed the buyer on the above-described equipment which review included the Operator's Manual content, equipment care, adjustments, safe operation, and applicable warranty policy.

Date _____
Dealer's Rep. Signature _____

The above equipment and Operator's Manual have been received by me, and I have been thoroughly instructed as to care, adjustments, safe operation, and applicable warranty policy.

Date _____
Owner's Signature _____

White - FAST
Yellow - Dealer
Pink - Customer



FAST DP9D / DP13D / DP14D Series DuraPlacer

DURAPLACER SERIAL NUMBER _____

DATE PURCHASED _____ / _____ / _____

BIN MANUFACTURER (CIRCLE ONE) **MONTAG** **LYNX**

NUMBER OF ROW UNITS _____

TONNAGE (CIRCLE ONE)

9T Single Bin

13T Dual Bin

14T Single Bin



Inspections

Pre-Delivery

After the machine has been completely assembled, inspect it to be sure it is in good running order before delivering it to the customer. Ensure each item is found satisfactory or proper adjustment to the item(s) is made.

The following checklist is a reminder of points to inspect. It is neither an exclusive nor an exhaustive list of points to inspect. See the [Warranty Inspection Report](#) for a formal list.

- **SMV** emblem is installed, protective **shipping tape** is removed from reflectors, and **lights** are installed.
- All **grease fittings** are lubricated (see [LUBRICATION and MAINTENANCE](#) section in this Manual.)
- Inspect to be sure all **nuts** are tightened to proper torque and all **cotter pins** are spread.
- The **tires** are properly inflated (see [SPECIFICATIONS](#)).
- **Wheel bolts** are tightened to their specified torque(s).
- Fertilizer **row units** are properly adjusted.
- Warning **lights** are properly installed and operational.
- All customer-ordered **attachments** are installed or are available for delivery.
- Any parts scratched in shipment are touched up with **paint**.
- All **shipping decals** are removed.
- **Transport pins** are inserted in the transport holes.

This machine has been thoroughly checked and to the best of my knowledge is ready for delivery to the customer.

Signed: _____

Date: _____



Delivery

The following checklist is a reminder of information which should be conveyed directly to the customer at the time the machine is delivered.

Check off each item as it is fully relayed to the customer.

- Tell the customer to use proper tools.
- Explain to the customer that the life expectancy of this or any other machine depends on regular lubrication as directed in Operator's Manual.
- Make the customer aware of all safety precautions that must be followed while using this machine.
- When the machine is transported on a road or highway at night or during the day, accessory lights and devices should be used for adequate warning to Operators of other vehicles. For this matter, tell the customer to check local governmental regulations.
- Give the Operator's Manual to the customer and explain all operating adjustments.

To the best of my knowledge, this machine has been delivered ready for field use, and the customer has been fully informed as to its proper care and operation.

Signed: _____

Date: _____



After-Sale

The following is a suggested list of items to be checked at a dealer-customer mutually agreeable time during the first operating season.

- Check with the customer as to performance of machine. Make certain proper operating adjustments are understood.
- If possible, operate the machine to see that it is functioning properly.
- Acquaint the customer with any special attachment which will help do a better job.
- Go over the entire machine for loose or missing hardware.
- Check for broken or damaged parts.
- Ask the customer if recommended periodic lubrication has been performed.
- Review the Operator's Manual with the customer and stress the importance of proper lubrication and safety precautions.

Signed: _____

Date: _____



Owner Register

Model Number	P.I.N. Number
--------------	---------------

Name		
Address		
County	State	Date Purchased

Name		
Address		
County	State	Date Purchased

Name		
Address		
County	State	Date Purchased

Name		
Address		
County	State	Date Purchased

Foreword to the Owner



READ THIS MANUAL carefully to learn how to operate and service your machine correctly. Failure to do so could result in personal injury or equipment damage. This Manual and safety signs on your machine may also be available in other languages.

THIS MANUAL SHOULD BE CONSIDERED a permanent part of your machine and should remain with the machine when you sell it.

MEASUREMENTS in this Manual are given in both metric and customary U.S. unit equivalents. Use only correct replacement parts and fasteners. Metric and inch fasteners may require a specific metric or inch wrench.

RIGHT-HAND AND LEFT-HAND sides are determined by facing in direction that the implement will travel when going forward.

WRITE PRODUCT IDENTIFICATION NUMBERS (P.I.N.) in the [Specification](#) section and in the [Owner Register](#). Accurately record all numbers to help in tracing your machine should it be stolen. Your dealer also needs these numbers when you order parts. File identification numbers in a safe place off-machine.

BEFORE DELIVERING THIS MACHINE, your dealer performed a pre-delivery inspection.

THIS DRY DURAPLACER IS DESIGNED SOLELY for use in customary agricultural or similar operations for the purpose of strip freshening row crops (“Intended Use”). Use in any other way is considered as contrary to the Intended Use. The manufacturer accepts no liability for damage or injury resulting from this misuse, and these risks must be borne solely by the user. Compliance with and strict adherence to the conditions of operation, service, and repair as specified by the manufacturer also constitute essential elements for the Intended Use.



THIS DRY DURAPLACER SHOULD BE OPERATED, serviced, and repaired only by persons familiar with all its particular characteristics and acquainted with the relevant safety rules (Accident Prevention). The Accident Prevention regulations, all other generally recognized regulations on safety and occupational medicine and the road traffic regulations must be observed at all times.

Any arbitrary modifications carried out on this Dry DuraPlacer will relieve the manufacturer of all liability for any resulting damage or injury.

THIS DOCUMENT outlines the specific design and performance requirements for the use of a Fast Ag Solutions Dry DuraPlacer assembly. The word “must” in this document indicates a mandatory requirement. The use of “should” indicates a recommendation of that which is advised but not required.

WARRANTY is provided as part of Fast Ag Solutions' support program for customers who operate and maintain their equipment as described in this Manual. The warranty is explained on the warranty certificate which you should have received from your dealer.

This warranty provides you with assurance that Fast Ag Solutions will back its products where defects appear within the warranty period. In some circumstances, Fast Ag Solutions also provides field improvements, often without charge to the customer, even if the product is out of warranty. Should equipment be abused or modified to change its performance beyond original factory specifications, the warranty will become void and field improvements may be denied.

TIRE MANUFACTURER'S warranty applicable to your machine may not apply outside U.S.

If you are not the original owner of this machine, it is in your interest to contact your local Fast Ag Solutions dealer to inform them of this unit's serial number. This will help Fast Ag Solutions notify you of any issues or product improvements.

INTRODUCTION



Read this Manual carefully before operating your FAST equipment. The information presented will prepare you to safely operate and service your machine.

All Operators are required to read this Manual carefully and be acquainted with all the operating and adjustment procedures before attempting to operate. Failure to follow the information in this Manual and on decals may result in personal injury or equipment damage.

This Manual should be considered a permanent part of this equipment and should remain with the equipment when you sell it. Replacement manuals can be obtained from your Fast Ag Solutions dealer.

This equipment has been engineered and manufactured to provide dependable and satisfactory use. Like all mechanical products, it will require cleaning and upkeep. Inspect your equipment before putting it into service. Your authorized Fast Ag Solutions dealer has trained mechanics, genuine FAST service parts, and the necessary tools and equipment when service is needed. Use only genuine FAST parts for service or repairs. Substitute parts will void the warranty and may not meet standards for safe and satisfactory operation.

Warranty is provided as part of Fast Ag Solutions' support program for customers who operate and maintain their equipment as described in this Manual. The warranty is explained on the warranty certificate you should have received from your dealer. This warranty provides you with the assurance that Fast Ag Solutions will back its products where defects appear within the warranty period. Should the equipment be abused or modified to change its performance beyond the original factory specifications, the warranty will become void.

These instructions have been compiled from field experience and engineering data. Some information may be general in nature due to unknown and varying operating conditions. However, through experience and these instructions, you should be able to develop procedures suitable to your particular situation.

.....

The illustrations and data used in this Manual were current at the time of printing. However, due to possible in-line production changes, your machine may vary slightly in detail. We reserve the right to redesign and change the machines as necessary without notification.

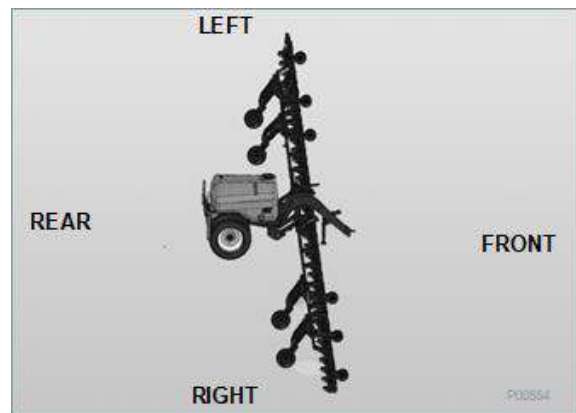

Figure 1: Orientation is viewed from behind the machine.

SAFETY

The most important safety device on this equipment is a safe Operator. It is the Operator's responsibility to read and understand and follow all safety and operating instructions in this Manual.

As the Operator, you are responsible for the safe operation and maintenance of this equipment. You must ensure that you and anyone else who is going to operate, maintain or work around the machine is familiar with the operating and maintenance procedures and related safety information contained in this Manual.

You are the key to safety. Good safety practices protect you and the people around you. Be certain that everyone operating this equipment is familiar with the recommended operating and maintenance procedures and follows all safety precautions. Do not risk injury or death by ignoring good safety practices.

Safety Alert Symbols and Signal Words



This is a Safety Alert Symbol. When you see this symbol on your machine or in this Manual, be alert to the potential for personal injury.

Follow recommended precautions and safe operating practices.

Understand Signal Words

Throughout this Manual, the terms *CAUTION*, *WARNING*, and *DANGER* are used along with the Safety Alert Symbol to indicate the degree of personal safety hazard. The term *IMPORTANT* is used to indicate that failure to observe the hazard can cause damage to the equipment.



DANGER identifies the most serious hazards. DANGER or WARNING safety signs are located near specific hazards. General precautions are listed on CAUTION safety signs. CAUTION also calls attention to safety messages in this Manual.

Follow Safety Instructions

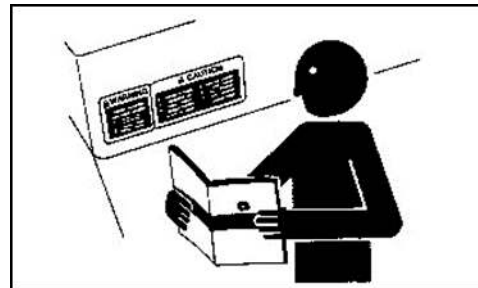

Carefully read all safety messages in this Manual and on your machine's safety signs. Keep safety signs in good condition.

Replace missing or damaged safety signs. Be sure new equipment components and repair parts include the current safety signs. Replacement safety signs are available from your Fast Ag Solutions dealer. There can be additional safety information contained on parts and components sourced from suppliers that is not reproduced in this Operator's Manual.

Learn how to operate the machine and how to use controls properly. Do not let anyone operate without instruction.

Keep your machine in proper working condition. Unauthorized modifications to the machine may impair the function and/or safety and affect machine life.

If you do not understand any part of this Manual and need assistance, contact your Fast Ag Solutions dealer.

General Safety

Prepare for Emergencies

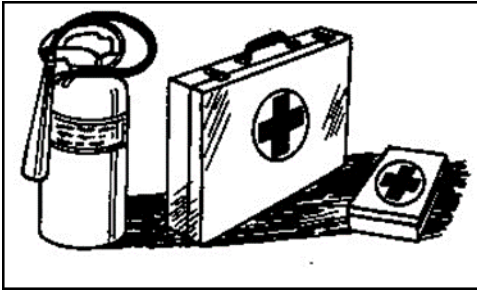

Be prepared if a fire starts.

Keep a first aid kit and fire extinguisher handy.

Keep emergency numbers for the poison control center, doctors, ambulance service, hospital, and fire department near your telephone.

Wear Protective Clothing

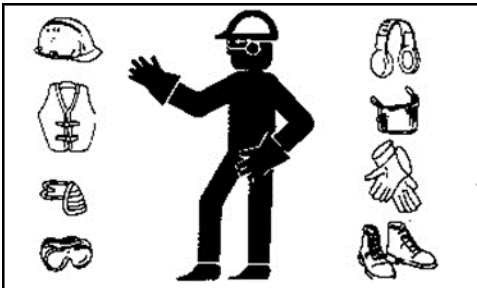

Wear close-fitting clothing and safety equipment appropriate to the job.

Operating equipment safely requires the full attention of the Operator. Do not wear radio or music headphones while operating the machine.

Protect Against Noise



Prolonged exposure to loud noise can cause impairment or loss of hearing.

Wear a suitable hearing protective device such as earmuffs or earplugs to protect against objectionable or uncomfortable loud noises.

Practice Safe Maintenance



Understand service procedures before doing work. Keep the area clean and dry.

Never lubricate, service, or adjust the machine while it is moving. Keep hands, feet, and clothing away from power-driven parts. Disengage all power and operate controls to relieve pressure. Lower equipment to the ground. Stop the engine. Remove the key. Allow machine to cool. Securely support any

machine elements that must be raised for service work.

Keep all parts in good condition and properly installed. Fix any damage immediately. Replace worn or broken parts. Remove any buildup of grease, oil, or debris.

On self-propelled equipment, disconnect the battery ground cable (-) before making any adjustments on electrical systems or welding on the machine.

On towed implements, disconnect wiring harnesses from tractor before servicing electrical system components or welding on the machine.

Support Raised Equipment



Always use a safety support when working on, under, or around the machine. Transport/Service locks can be used for this purpose.

Shut off the tractor's engine and remove the key when working on the machine.

If air has been allowed to enter hydraulic hoses or cylinders, bleed the hydraulic system before use. If there is a failure in the hydraulic system, unsupported or raised equipment could suddenly lower, causing serious personal injury or death.

If support is not available, completely lower wings and frame, relieve hydraulic pressure and disconnect hoses from tractor.

Avoid Heating Near Pressurized Fluid Lines



Flammable spray can be generated by heating near pressurized fluid lines, resulting in severe burns to yourself and bystanders. Do not heat by welding, soldering, or using a torch near pressurized fluid lines or other flammable materials. Pressurized lines can accidentally burst when heat goes beyond the immediate flame area.

Avoid High-Pressure Fluids



Inspect hydraulic hoses periodically – at least once per year – for leakage, kinking, cuts, cracks, abrasion, blisters, corrosion, exposed wire braid, or any other signs of wear or damage.

Replace worn or damaged hose assemblies immediately with Fast Ag Solutions approved replacement parts.

Escaping fluid under pressure can penetrate the skin causing serious injury.

Avoid the hazard by relieving pressure before disconnecting hydraulic or other lines. Tighten all connections before applying pressure.

Search for leaks with a piece of cardboard. Protect hands and body from high-pressure fluids.

If an accident occurs, see a doctor immediately. Any fluid injected into the skin must be surgically removed within a few hours or gangrene may result. Doctors unfamiliar with this type of injury should reference a knowledgeable medical source.

Inspect Lift Circuit Hoses

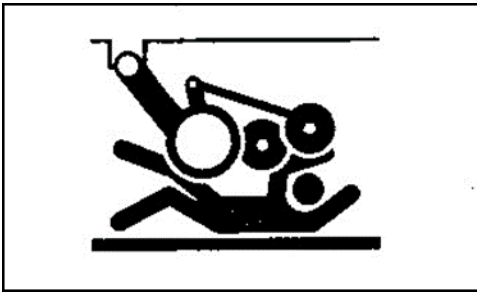

Avoid serious injury or death while working under a raised implement. Hydraulic hoses between the lift cylinders and hydraulic lock-up valves should be inspected frequently for leakage, kinking, cuts, cracks, abrasion, blisters, corrosion, exposed wire braid, or any other signs of wear or damage. Worn or damaged hose assemblies can fail during use and should be replaced immediately. See your Fast Ag Solutions dealer for replacement hoses.

Store Attachments Safely

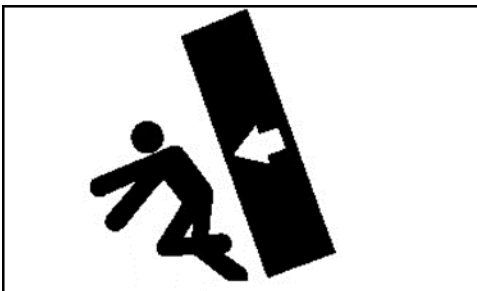

Stored attachments such as dual wheels can fall and cause serious injury or death. Securely store attachments and implements

to prevent falling. Keep playing children and bystanders away from storage area.

Electrical



Check all electrical wiring and connections for damage. Keep the battery terminals clean and tight. Repair or replace any damaged part or wires that are loose or frayed.

Service Tires Safely

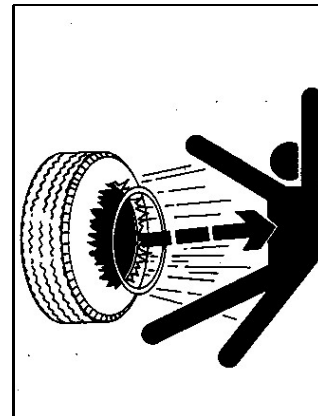

CAUTION: Explosive separation of a tire and rim parts can cause serious injury or death.

Do not attempt to mount a tire unless you have the proper equipment and experience to perform the job.

Always maintain the correct tire pressure. Do not inflate the tires above the recommended pressure. Never weld or heat a wheel and tire assembly. The heat can cause an increase in air pressure resulting in a tire explosion. Welding can structurally weaken or deform the wheel.

When inflating tires, use a clip-on chuck and extension hose long enough to allow you to stand to one side and NOT in front of or over

the tire assembly. Use a safety cage if available.

Check wheels for low pressure, cuts, bubbles, damaged rims, or missing lug bolts and nuts. Replace as necessary.

Dispose of Waste Properly

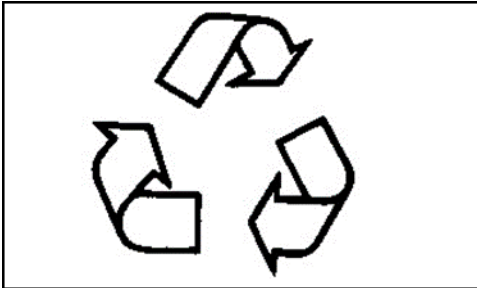

Improperly disposing of waste can threaten the environment and ecosystem. Potentially harmful waste used with equipment includes such items as oil, fuel, coolant, brake fluid, filters, and batteries.

Use leakproof containers when draining fluids. Do not use food or beverage containers that may mislead someone into drinking from them.

Do not pour waste onto the ground, down a drain, or into any water source.

Air conditioning refrigerants escaping into the air can damage the Earth's atmosphere. Government regulations may require a certified air conditioning service center to recover and recycle used air conditioning refrigerants.

Handle Agricultural Chemicals Safely

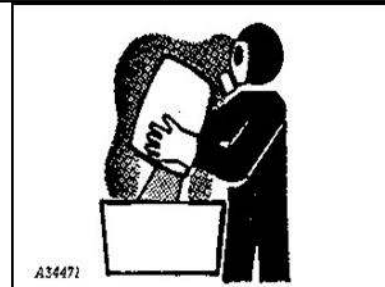
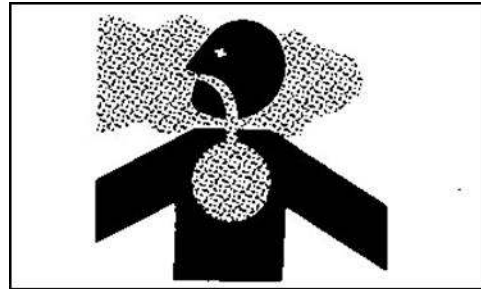

Chemicals used in agricultural applications such as fungicides, herbicides, insecticides, pesticides, rodenticides, and fertilizers can be harmful to your health or the environment if not used carefully.

Always follow all label directions for effective, safe, and legal use of agricultural chemicals.

Reduce risk of exposure and injury:

Wear appropriate personal protective equipment as recommended by the manufacturer. In the absence of manufacturer's instructions, follow these general guidelines:

Chemicals labeled 'Danger' (Most toxic) generally require use of goggles, respirator, gloves, and skin protection.

Chemicals labeled 'Warning' (Less toxic) generally require use of goggles, gloves, and skin protection.

Chemicals labeled 'Caution' (Least toxic) generally require the use of gloves and skin protection.

Avoid inhaling vapor, aerosol, or dust.

Always have soap, water, and a towel available when working with chemicals. If a chemical contacts skin, hands, or face, wash

immediately with soap and water. If chemical gets into eyes, flush immediately with water.

Wash hands and face after using chemicals and before eating, drinking, smoking, or urination.

Do not smoke or eat while applying chemicals.

After handling chemicals, always bathe or shower and change clothes. Wash clothing before wearing it again.

Seek medical attention immediately if illness occurs during or shortly after use of chemicals.

Keep chemicals in original containers. Do not transfer chemicals to unmarked containers or to containers used for food or drink.

Store chemicals in a secure, locked area away from human or livestock food. Keep children away.

Always dispose of containers properly. Triple rinse empty containers and puncture or crush containers and dispose of properly.

Handle Chemical Products Safely



Direct exposure to hazardous chemicals can cause serious injury. Potentially hazardous chemicals used with FAST equipment include such items as lubricants, coolants, paints, and adhesives.

A Material Safety Data Sheet (M/SDS) provides specific details on chemical products: physical and health hazards, safety procedures, and emergency response techniques.

Check the M/SDS before you start any job using a hazardous chemical. That way you will know exactly what the risks are and how to do the job safely. Then follow the procedures with the recommended equipment.

Operate Hydraulics Safely



Before operating, make sure air has been bled from wing-fold hydraulic system.

Be sure the area around the machine is clear before raising or lowering the machine's frame or wings.

Do not operate with wings folded.

Do not operate close to the edge of a ditch, creek, gully, or steep embankment. Avoid holes, ditches, and obstructions which may cause the tractor, machine, or towed equipment to roll over, especially on hillsides.

Avoid sharp turns on hillsides.

Slow down when turning, traveling over rough ground, or when turning on inclines.

Always shut off tractor and shift to PARK or set brakes when leaving tractor. Remove key when leaving tractor unattended.

Always have the tractor stop on level ground when raising or lowering wings. Operate the machine from tractor seat only. If chemicals are used, follow the manufacturer's recommendations for handling and storage.

Tow the machine behind a properly equipped tractor only.

Use Safety Lights and Devices

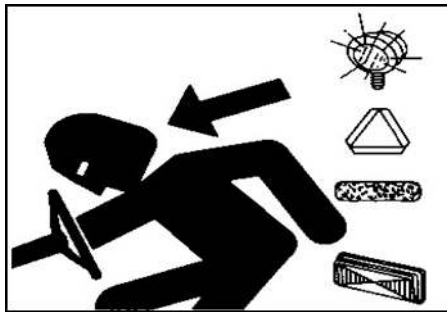

Prevent collisions between other road users, slow moving tractors with attachments or towed equipment, and self-propelled machines on public roads. Frequently check for traffic from the rear, especially in turns, and use turn signal lights.

Use headlights, flashing warning lights, and turn signals during both day and night. Follow local regulations for equipment lighting and marking. Keep lighting and marking visible, clean, and in good working order. Replace or repair lighting and marking that has been damaged or lost.

Keep Riders Off Machine

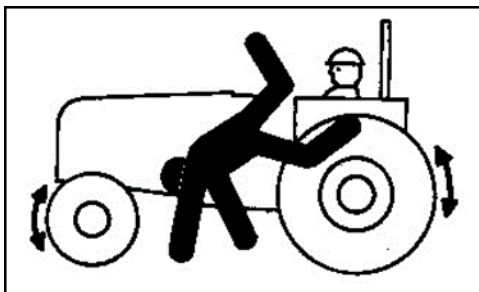

Only allow the Operator on the machine. Keep riders off.

Riders on the machine are subject to injury such as being struck by foreign objects and being thrown off of the machine. Riders also obstruct the Operator's view resulting in the machine being operated in an unsafe manner.

Observe Maximum Transport Speed

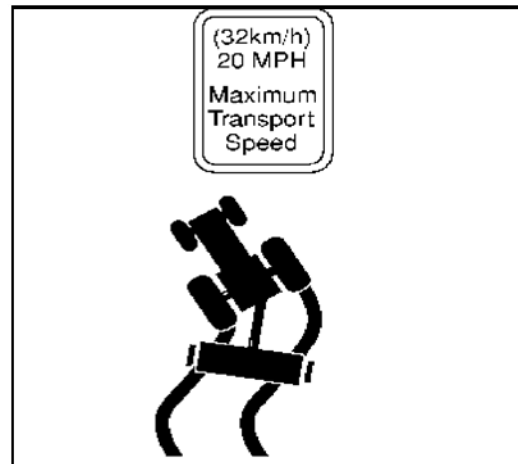

⚠ CAUTION: Be sure all bystanders are clear of DuraPlacer.

⚠ IMPORTANT: Transport DuraPlacer only with tank EMPTY to prevent DuraPlacer damage.

This implement is not equipped with service or parking brakes. The maximum transport speed for this implement is 20 mph (32 km/h).

Some tractors are capable of operating at speeds that exceed the maximum transport speed of this implement. Regardless of the maximum speed capability of the tractor being used to tow this implement, do not exceed the implement's maximum transport speed.

Exceeding the implement's maximum transport speed can result in:

- Loss of control of the tractor/implement combination.
- Reduced or no ability to stop during braking.
- Implement tire failure.
- Damage to the implement structure or its components.

Use additional caution and reduce speed when towing under adverse surface conditions, when turning, and when on inclines. For transport, the weight of the

EMPTY DuraPlacer must not be more than 1.5 times the weight of the tractor. The minimum towing tractor weight for the Dry DuraPlacer is 22100 lbs. (10024 kg).

Never tow this implement with a motor vehicle. Tow only with a properly ballasted tractor.

EC Compliance Notification



⚠ WARNING: Environmental transportation hazard. A loaded machine driven on public roads has a high risk of tire failure. Do not use the machine for transporting product(s) on public roads.

Never transport with a tank filled with any liquids or chemical(s).

Use a Signal Person

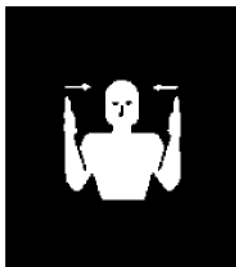

Use a signal person to direct movement of the tractor/fertilizer cart combination, whenever the tractor operator's view is obstructed.

Designate one individual as THE signal person. Always have the signal person stand in clear view. Be sure the signal person stays a safe distance away from the machine when it is moving.

Prior to starting the tractor, discuss hand signals and what each signal means to avoid

misunderstandings and confusion which could result in a serious injury or fatal accident for someone.

Keep all bystanders away whenever the machine is moved.

Use a Safety Chain

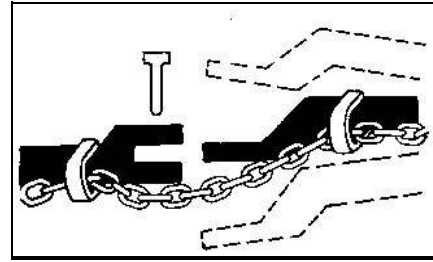

A safety chain will help control drawn equipment should it accidentally separate from the drawbar.

Using the appropriate adapter parts, attach the chain to the tractor drawbar support or other specified anchor location. Provide only enough slack in the chain to permit turning.

Tow Loads Safely



Stopping distance increases with speed and weight of towed loads and on slopes. Towed loads with or without brakes that are too heavy for the tractor or are towed too fast can cause loss of control. Consider the total weight of the equipment and its load.

Observe these recommended maximum road speeds or local speed limits which may be lower:

If towed equipment does not have brakes, do not travel more than 32 km/h (20 mph) and

do not tow loads more than 1.5 times the tractor weight.

Ensure the load does not exceed the recommended weight ratio. Add ballast to the recommended maximum for the tractor, lighten the load, or get a heavier towing unit. The tractor must be heavy and powerful enough with adequate braking power for the towed load. Use additional caution when towing loads under adverse surface conditions, when turning, and on inclines.

Avoid Overhead Power Lines

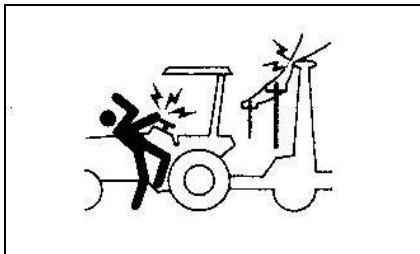

⚠️ WARNING: Keep away from overhead power lines. Serious injury or death may result.

Proceed cautiously under overhead power lines and around utility poles. Know the transport height of your machine. Electrocutation can occur without direct contact with overhead electrical lines.

Prepare for Transport

⚠️ CAUTION: Avoid serious injury or death to your or others.

Never tow the machine behind a truck or other motor vehicle. This machine is designed only to be towed with a properly sized and ballasted tractor.

Use a tractor large enough to maintain control. Properly ballast tractor for towing your machine. Refer to tractor Operator's Manual and this Manual to ensure that

machine can be safely transported with your tractor.

Be aware of height and width restrictions to avoid a collision with overpasses or other road users.

Always fold wings fully. If wing fold cylinders are removed, chain wings together to prevent accidental lowering. Fully raise frame, close hydraulic lock-up valve (if equipped) and install Transport/Service locks before transporting. Latch the tractor brakes together.

Attach a properly sized safety chain for the load being towed. Refer to [Use a Safety Chain](#).

⚠️ IMPORTANT: Do not transport on a roadway unless the machine is equipped with proper functioning lights and reflective markings or emblems.

Ensure that the lights and reflective markings or emblems are clean and visible. Contact your Fast Ag Solutions dealer for lights and lighting harnesses.

Always follow local and national regulations for equipment size, lighting and marking before driving on public roadways. You are responsible for understanding and complying with all requirements regarding roadway transport. Refer to [Use Safety Lights and Devices](#).

Transport Safely



! CAUTION: When transporting, always travel at a reasonable and safe speed which permits adequate control of steering and stopping.

Reduce speed considerably when traveling over rough ground. Be certain everyone is clear of the machine.

Do not exceed weight and speed guidelines. Refer to [Observe Maximum Transport Speed](#).

Towed loads can swerve and upset or cause loss of control. Refer to [Tow Loads Safely](#). Shift tractor into a lower gear when transporting down steep slopes or hills; never coast. Stop slowly.

Wide turns may be required with the machine in tow. Use caution in traffic and in congested areas.

To improve stability when traveling through the field, wings should be unfolded from transport position as soon as possible after leaving the roadway.

! IMPORTANT: When transporting the machine on a roadway, **ALWAYS USE** appropriate lamps and devices for adequate warning to operators of other vehicles.

Refer to [Use Safety Lights and Devices](#).

Park Safely

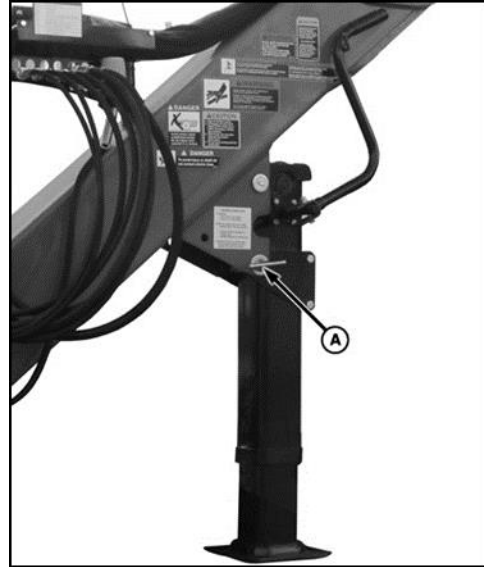

Parked Jack Position

A - Pin

Park the machine on a level surface, lower the jack, and retain it with pin (A). Block implement wheels.

Replace Safety Signs

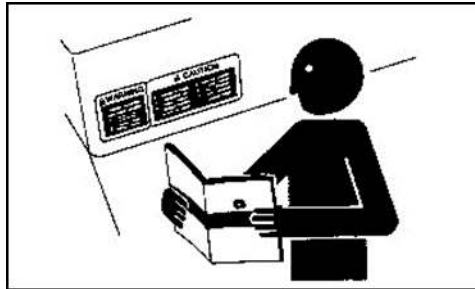

Replace missing or damaged safety signs. Use this Operator's Manual for correct safety sign placement.

There can be additional safety information contained on parts and components sourced from suppliers that is not reproduced in this Operator's Manual.

Hitch

A

⚠ DANGER

Avoid serious injury or death from runover. Do not adjust while machine is in motion.

B

⚠ CAUTION

1. Keep all shields in place
2. Disengage and shut off all engine and/or motor power before servicing or unclogging machine.
3. Keep hands, feet and clothing away from powerdriven parts.
4. Do not leave running machine unattended.

C

⚠ WARNING

Be sure cylinder and attaching hoses are fully charged with oil before operating system. Failure to do so will allow wings to fall rapidly when attempting to lower from transport position.

D

⚠ CAUTION

Agricultural chemicals can be dangerous. Improper selection or use can injure persons, animals, plants, soils or other property.

TO AVOID INJURY

1. Select the right chemical for the job.
2. Handle and apply it with care. Follow Instructions Issued by the chemical manufacturer.

A



WARNING

Do not exceed this implement's maximum transport speed of 50 km/h (30 mph). Exceeding this speed may result in loss of control during transport or braking and result in injury or death.

WARNING

Transport only with a properly ballasted tractor and a properly adjusted safety low chair. Do not transport with a motor vehicle. Reduce speed and use additional caution when on hills, towing, under adverse surface conditions, and turning.



B

WARNING

Avoid serious injury from injection of pressurized hydraulic fluid. Always relieve pressure before performing service or maintenance on any hydraulic components. Refer to tractor and Implement Operator's Manuals. Do not use hand to search for leaks. Use cardboard or similar material.



C

DANGER

To avoid injury or death do not contact electric lines

Wing



A

WARNING



To avoid injury or death, stand clear of wing during fold and unfold operation.



B

DANGER



To avoid injury or death stand clear of machine when wings are being folded or unfolded. Mechanical or hydraulic failure can allow wings to fall rapidly.

Main Frame

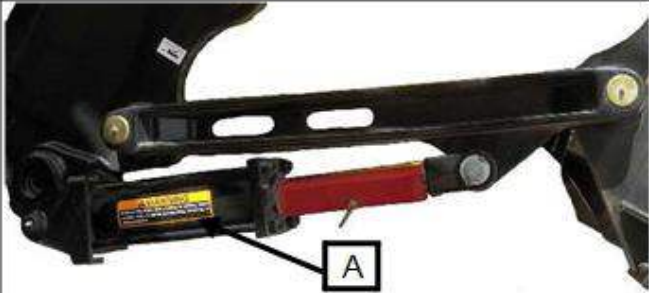

A

⚠ WARNING

Avoid serious injury from crushing or pinning. Install cylinder lockups before transporting, servicing, or storing machine.

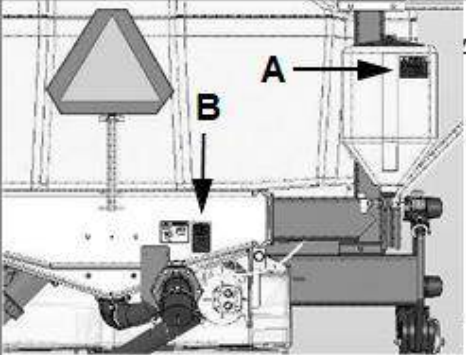

⚠ WARNING

Water for rinse/wash purpose only. Do not drink from this container. Container may become contaminated by sprayer chemicals. Fill with clean rinse water only.

⚠ CAUTION

Agricultural chemicals can be dangerous. Improper selection or use can injure persons, animals, plants, soils or other property.

TO AVOID INJURY

1. Select the right chemical for the job.
2. Handle and apply it with care. Follow instructions issued by the chemical manufacturer.

Wheel and Tracks



A

ATTENTION: PLEASE CHECK LUG NUT TORQUE AT 5, 10, AND 50 HOURS OF OPERATION, AND REGULARLY THEREAFTER. TORQUE SHOULD BE 265 FT/LBS.

⚠ CAUTION

HELP PREVENT FIRE

Trash build-up between tracks and chassis can cause fire from increased friction.

- Keep machine free of trash.
- Keep a fire extinguisher at hand.

Safety Features

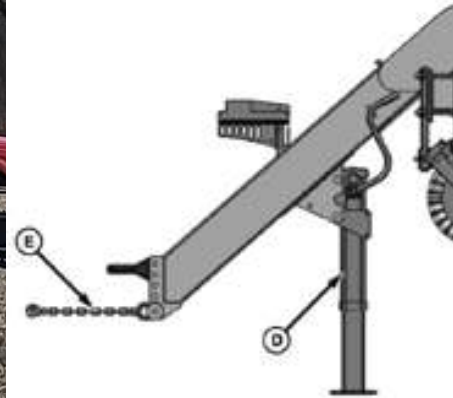
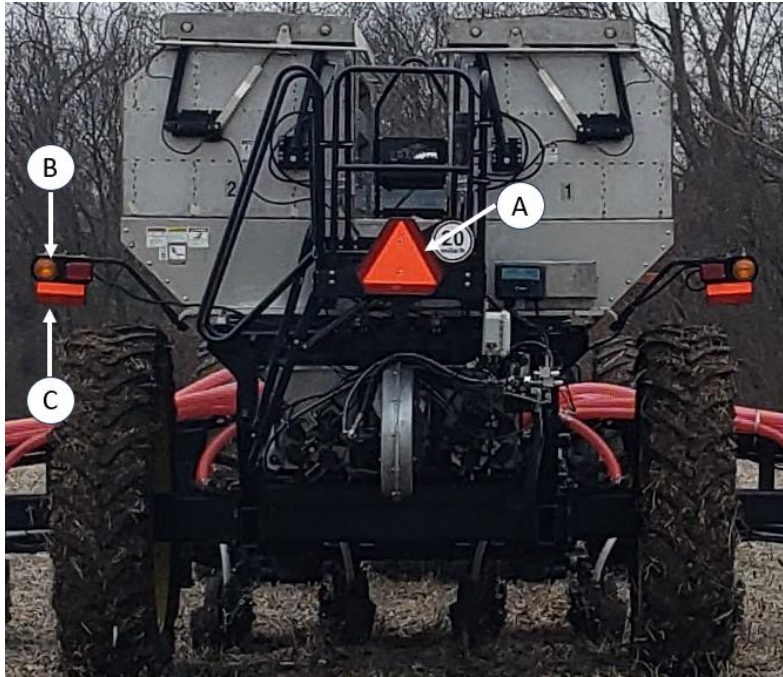

- A. SMV Emblem
 - i. Identifies slow-moving equipment and alerts traffic approaching from the rear.
- B. Warning Lights
 - i. Alert other drivers to the machine's presence and width of slow-moving machinery on roadways and signal turns.
- C. Reflectors
 - i. Alert other drivers to the machine's presence and width of slow-moving machinery on roadways.
- D. Jack
 - i. Prevents the machine from falling when in storage.
- E. Safety Chain
 - i. Will help control the machine should it accidentally separate from tractor drawbar.

In addition to the safety features shown here, other components, systems, safety signs on the machine, safety messages, and instructions in the Operator's Manual contribute to the safe operation of this machine when combined with the care and concern of a capable Operator.

The construction of this implement may not meet all local or national requirements for transport on a public roadway. In regions or countries that have national certification requirements for roadway transport, it may be impossible for this implement to be approved for such roadway transport. The customer is responsible for understanding and complying with all local, regional, and national requirements regarding roadway transport.



Sign-Off Form

Fast Ag Solutions follows the general Safety Standards specified by the American Society of Agricultural Engineers (ASAE) and the Occupational Safety and Health Administration (OSHA). Anyone who will be operating and/or maintaining the FAST Dry DuraPlacer must read and clearly understand ALL Safety, Operating, and Maintenance information presented in this Manual.

Do not operate or allow anyone else to operate this equipment until such information has been reviewed. Annually review this information before season start-up.

A sign-off sheet is provided as a template for your records to show that all personnel who will be working with the equipment (Operators) have read and understand the information in this Manual and have been instructed in the safe operation, service, and maintenance of the equipment.

Date	Employee's Signature	Employer's Signature

SPECIFICATIONS

Tractor Power, Size Recommendation

Use the machine with a tractor providing drawbar power in the following ranges:

Tonnage, T _{UK} (T _{US})	Machine size, m (ft)	Tractor Power, kW (HP)	Min. Tractor Weight, kg (lbs.)
8.0 (9)	12.2 (40)	347-403 (465-540)	7,076 (15,600)
11.6 (13)	12.2 (40)	363-422 (487-566)	8,981 (19,800)
12.5 (14)	12.2 (40)	362-421 (486-565)	8,391 (18,500)
8.0 (9)	18.3 (60)	500-581 (670-779)	8,754 (19,300)
11.6 (13)	18.3 (60)	516-600 (692-805)	10,659 (23,500)
12.5 (14)	18.3 (60)	515-599 (691-803)	10,024 (22,100)

⚠ IMPORTANT: Verify the main tank is empty before transporting on road.

Hydraulic System Requirements

A tractor hydraulic system with ISO hydraulic couplers is required.

Five tractor Selective Control Valves (SCV) at the listed flowrates and pressure are required for following:

Circuit	SCV Function	Flowrate	Pressure
1	Main Lift Cylinders and Main Wing Down Pressure (Kick) Cylinders	69 LPM (18 GPM)	20,684 kPa (206.8 bar) (3000 psi)
1	Flip Wing Down Pressure Cylinders	51 LPM (13 GPM)	20,684 kPa (206.8 bar) (3000 psi)
2	Wing Fold Valve Block	45 LPM (12 GPM)	20,684 kPa (206.8 bar) (3000 psi)
2	Latch Cylinder	15 LPM (4 GPM)	20,684 kPa (206.8 bar) (3000 psi)
3	Montag Hopper Delivery System	95 LPM (25 GPM)	20,684 kPa (206.8 bar) (3000 psi)
	Lynx Fan	129 LPM (34 GPM)	20,684 kPa (206.8 bar) (3000 psi)
4	Hitch-Tongue Lift Cylinder	15 LPM (4 GPM)	20,684 kPa (206.8 bar) (3000 psi)
5	Lynx Metering System	26 LPM (7 GPM)	20,684 kPa (206.8 bar) (3000 psi)



Machine Dimensions & Specifications

Model	DP9D	DP13D	DP14D
Transport Height	3.7m (12ft. 3in.)	3.7m (12ft. 3in.)	3.9m (12ft. 8in.)
Transport Width	4.6m (15ft. 3in.)		
Transport Overall Length	13.0m (42ft. 8in.)	14.7m (48ft. 4in.)	13.9m (45ft. 6in.)
Transport Pin-to-Axle Length	11.7m (38ft. 6in.)	11.8m (38ft. 8in.)	11.6m (37ft. 11in.)
Toolbar Size(s)	13.7m – 18.3m (40ft. - 60ft.)		
Toolbar Tube Size	18cm x 23cm (7in. x 9in.) rectangular		
Weight, empty	13,108 kg (28,899 lbs.)	15,512 kg (34,199 lbs.)	15,059 kg (33,199 lbs.)
Weight, full	21,395 kg (47,169 lbs.)	27,930 kg (61,575 lbs.)	27,759 kg (61,199 lbs.)
Tonnage	8 UK Ton (9 Ton)	12 UK Ton (13 Ton)	13 UK Ton (14 Ton)
Standard Tires	480/80R50 Singles	380/90R46 Duals	
Wheel-Wheel Outer Width	2.1m (6ft. 9in.)	3.5m (11ft. 6in.)	
Hydraulic Down Pressure	Yes		
Hydraulic Wing Kick	Yes		

PREPARING THE MACHINE

Use the Tractor Operator's Manual

Always refer to tractor operator's manual for specific detailed information regarding operation of equipment.



Pre-Operation Checklist

Efficient and safe operation of the machine requires that each Operator reads and understands operating procedures and all related safety precautions outlined in this section. A pre-operational checklist is provided for the Operator. It is important for both personal safety and maintaining the good mechanical condition of the DuraPlacer that this checklist be followed.

Before operating the DuraPlacer, check the following items:

1. Lubricate machine per the schedule outlined in the [LUBRICATION and MAINTENANCE](#) section.
2. Use only a tractor of adequate power and weight to operate the DuraPlacer. See the [SPECIFICATIONS](#) section for recommendations.
3. Be sure that the machine is properly attached to the tractor. Be sure that a mechanical retainer is installed through the drawbar and that a pin and safety chain are installed.
4. Inspect all hydraulic lines, hoses, fittings, and couplers for tightness. See [Tightening Hardware](#) for break-in period recommendations.
5. **IMPORTANT:** Extend the axles out of the shipping width setting and set the track or tire width for your application. The unit is shipped with axles to the narrowest setting using the shipping holes for shipping purposes only. See [SETTING AXLE WIDTH](#).
6. Check tires and verify they are inflated to the specified pressure. See [Checking Tire Pressure](#)
7. Check track tension and hardware torque.
8. Calibrate the DuraPlacer if at the start of the season or a new applicator rate is being used.
9. Check the condition and routing of all fluid hoses and lines. Be sure that all lines are routed in large arcs. Replace any that are damaged. Re-route those that are rubbed, pinched, or crimped. See [Replace Hydraulic Hoses](#).
10. Check placement components. Remove and replace any that are worn.
11. Remove all entangled material. Raise the toolbar and turn the metering pump slightly. Check that there is product coming out at each application site. Unplug or connect lines as required. Replace any plugged nozzles or tubes.

AXLES, TIRES, and TRACKS

Setting Axle Width

IMPORTANT: Adjust track axles out of the shipping width before transporting or application. Set axles to the widest setting possible to match row width. Use only the holes with measurements. See axle width charts.



1. Jack one side up on frame in front of axle and support the frame on the rear of the axle with jack stands (A). 10-ton jack stand shown.

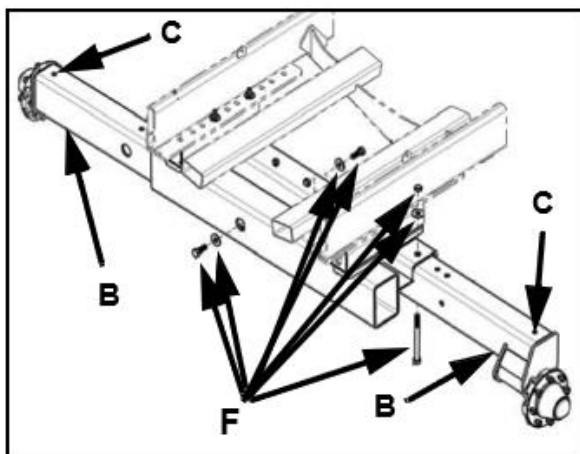

2. Remove the axle bolts (F) and slide the axles (B) out of shipping holes (C).

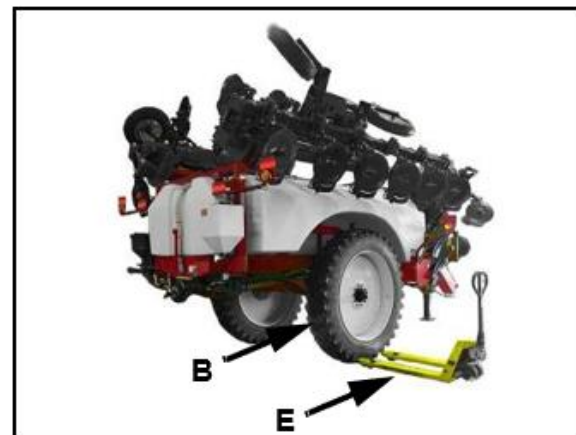
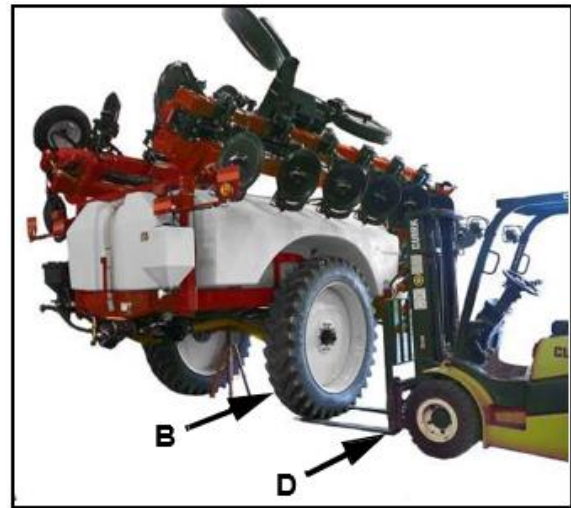

3. Using a forklift (D) or pallet jack (E), slide the wheel and axle tube (B) out to the holes matching row width (See axle width charts). Axles (B) must be moved out from shipping holes (C) to match crop spacing, to prevent crop damage, and for stability. Set both axles to the same width.
4. Reinstall the axle hardware with the threads facing up.
5. Torque the 5/8" bolts to 149 N-m (110 ft-lbs.) and the 3/4" bolts to 271 N-m (200 ft-lbs.).
6. Repeat for other side.

Axle Width Chart – Singles

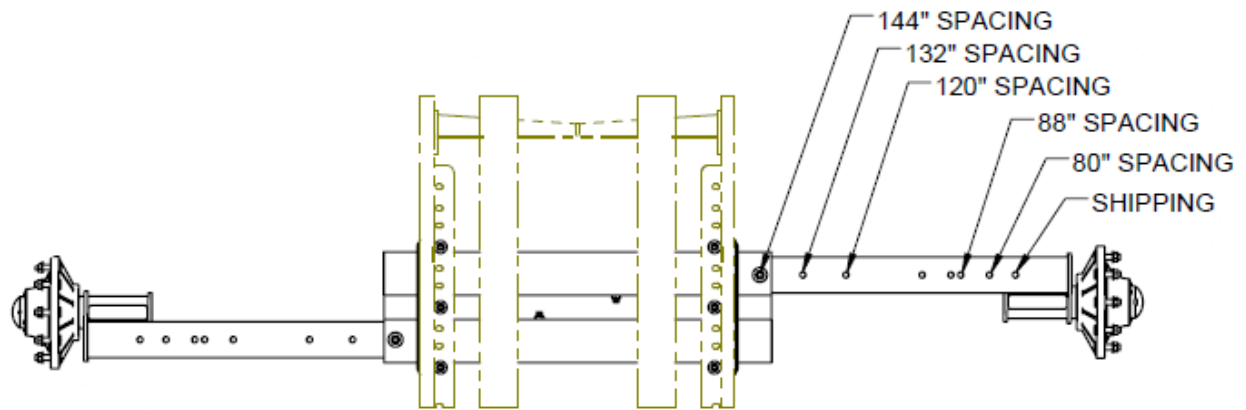

Figure 2: 20k (for 1800 Gal.) 72"-144" axle

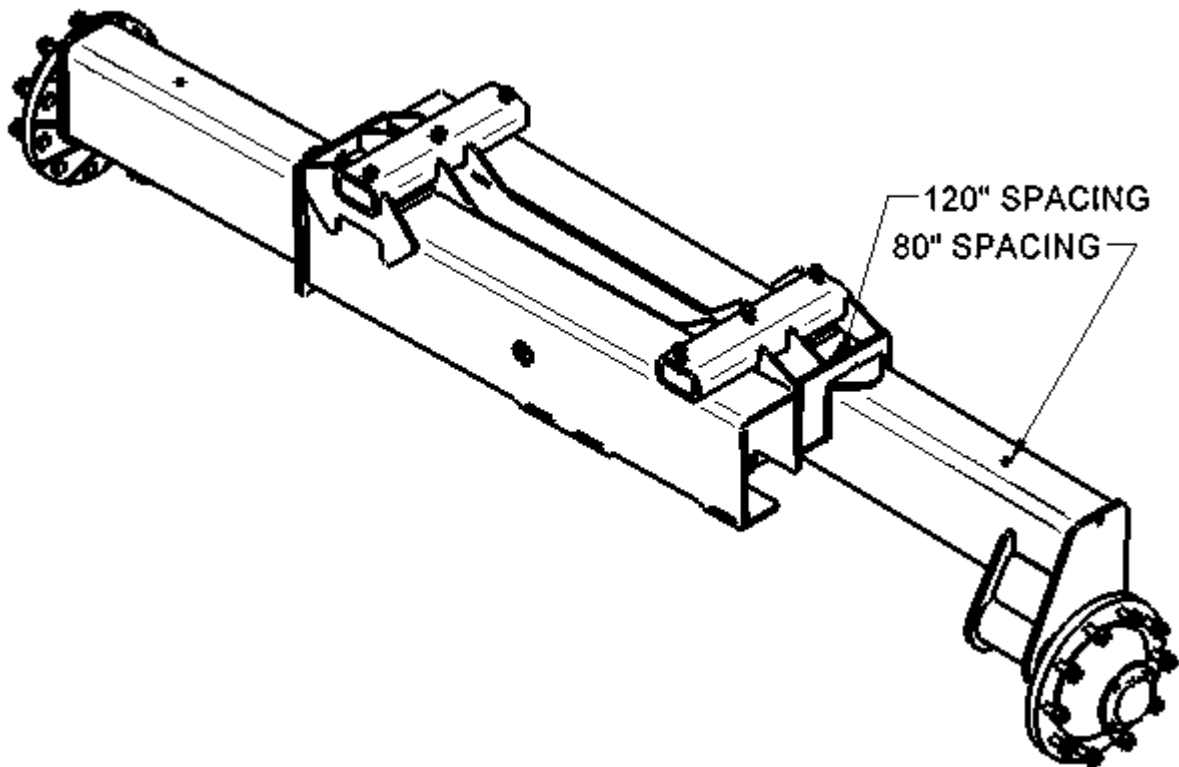
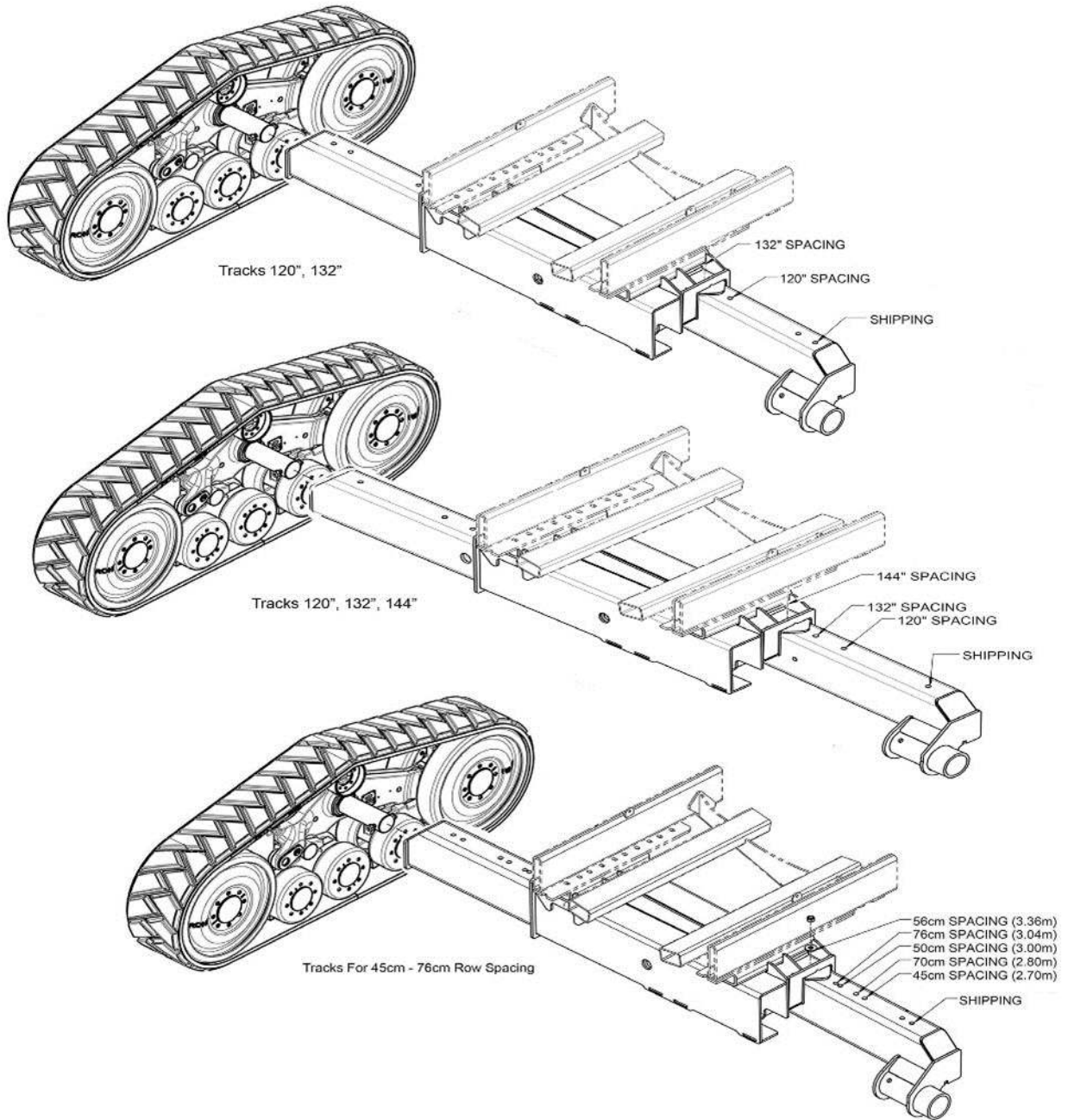

Figure 3: 25k (for 2400 Gal.) 80"-120" axle

Axle Width Chart – Tracks



Checking Tire Pressure

Check tire pressure and inflate as necessary.

⚠ CAUTION: Avoid loss of vehicle control during transport from failure of overloaded tires which could cause serious injury or death to you or others.

Equal pressure in all tires is necessary for even penetration. A low tire will cause deeper penetration on one side than the other. Increased penetration on one side will result in side-draft of the machine. Inflate tires to shown specification.

Tire Size	Pressure
480/80R50 LR176 (Singles)	359 kPa (3.59 bar) (52 psi)
580/85R42 LR183 (Singles)	280 kPa (2.80 bar) (41 psi)
380/90R46 LR149 (Duals)	255 kPa (2.55 bar) (37 psi) Inner 227 kPa (2.28 bar) (33 psi) Outer
380/90R54 LR152 (Duals)	255 kPa (2.55 bar) (37 psi) Inner 227 kPa (2.28 bar) (33 psi) Outer

⚠ NOTE: Tire pressure is directly linked to its Load Rating (LR###). Make sure of the load rating of the tire before adding any air to the tire.

Checking Wheel Nuts



- A. Main Frame Wheel Nut
- B. Gauge Wheel Nut

Check tightness of all wheel nuts (A) and (B) during the first week of operation and periodically after that.

Tighten all wheel bolts to specification.

Item	Specification
(A) Main Frame Wheel Nut	359 N-m (265 ft-lbs.)
(B) Gauge Wheel Nut	95 N-m (70 ft-lbs.)

Track Use

General Guidelines

- Before trailering on-road for the first time, precondition tracks. See [Track Systems Break-In](#).
- Avoid traveling at high speeds with a new set of tracks and wheels, especially during the first 50-100 hours.
- Trash build-up can cause fire from increased friction. Remove trash from trash build-up points between track and trailer frame.
- Avoid operating tracks in grease, oil, or other petroleum chemicals. Avoid spilling these materials on tracks and wheels during service.

Maximizing Track Life

Track carcasses are designed to exceed tread wear out, but only so long as the integrity of the carcass is maintained. It is critical to keep moisture out of the steel carcass and to avoid situations where localized cable overloading could occur. Track machine owners are advised to follow these guidelines to achieve maximum track life and avoid operational problems, all of which result in lower cost per operating hour:

- Minimize roading. Excessive roading can increase track wear up to 15 times field wear rates.
 - Minimize transport weight during road transport.
 - Reduce maximum travel speed especially during high ambient conditions.
- Use correct operational techniques.
 - Avoid skidding and tread bar scrubbing on hard surfaces to reduce track wear.
 - Use care when crossing ditches or transitions while making turns. Diagonal crossing of ditches causes track to become unsupported in the center and the idler(s) to hit the opposite embankment. This can cause momentary loss of tension that can drop the center section down and outside the drive or idler wheels making derailing a much higher risk if in a turn.
 - Use a ratchet-turn or bump steer technique. When turning at the end of a field, steering performance can be gained by turning in several small turns, returning to neutral position between each ratchet steer. This helps gain more traction and complete the turn more efficiently and with less ground disturbance than by attempting to power and spin through turn.
- Maintain correct track tension.
 - Under-tension causes rapid wear on tracks and the inside surface of the belt due to slippage and may potentially cause material buildup.
 - Over-tension adds extra load and stress to undercarriage bearings, internal track cables, and the track frame.
- Keep irregular material out of tracks.
 - Sharp, hard material inside the track is the primary reason for localized track tears and subsequent entry points for moisture into the track carcass.



Track System Break-In

Break-In Overview

Avoid roading at high speeds with a new set of tracks or wheels, especially during first 50-100 operating hours. Damage to drive lugs and wheels may result.

Track systems' break-in takes place during the first season of use. Correct break-in helps reduce amount of initial drive lug wear. During break-in, drive lugs and idlers undergo a "polishing in" process which:

- Scours out excess rubber flash inside the drive wheels.
- Embeds fine dust particles in rubber surfaces to remove tackiness of new rubber.

Surface polishing reduces frictional heating in the track system. During break-in, new rubber surfaces require contact with a dry lubricant such as soil. Avoid high speed operation (roading or higher speed tillage) where the track system is run in absence of dust generated by dry soil contact (wet conditions or paved roads). Operating in these conditions for lengthy periods may cause excessive early-hour drive lug wear.

Perform initial break-in and alignment before any high-speed tractor operation. Excessively clean frictional track components (belts, drive wheels, front idlers, and mid-rollers) can generate significant heat if run unlubricated. This heat is capable of damaging components. Break-in and align new components as outlined.

Initial Break-In

Avoid track and track system component damage. Before driving the tractor on-road for the first time, precondition tracks with loose soil or clay-based lubricant. Repeat application of lubricant or soil at least every 50 miles until destination is reached.

After installation of new or cleaned track belts or other frictional components, expose clean components to materials to lubricate and break them in.

- Work the DuraPlacer in-field in loose soil for at least 15 minutes.
- If the DuraPlacer cannot be exposed to loose soil, use a "clay-based" granular material (clay-based lubricant, kitty litter, oil-dry absorbent, or talc powder) to introduce a "joint" area between drive wheels and belts continuously for at least 15 minutes.

Track Belt Alignment

After the initial break-in procedure is completed, align the track. See [Check Track Alignment](#).

After Break-In

After the initial 100-hour break-in and alignment, a long-term break-in process (up to 400 hours) will likely occur. During this period, maximize the exposure of tracks to soft soil and minimize high speed, heavily loaded transport operation.

Track Wear & Trash Buildup

Avoid grease, oil, or other petroleum chemicals on tracks and wheels. Constant exposure to petroleum-based chemicals may damage rubber surfaces.

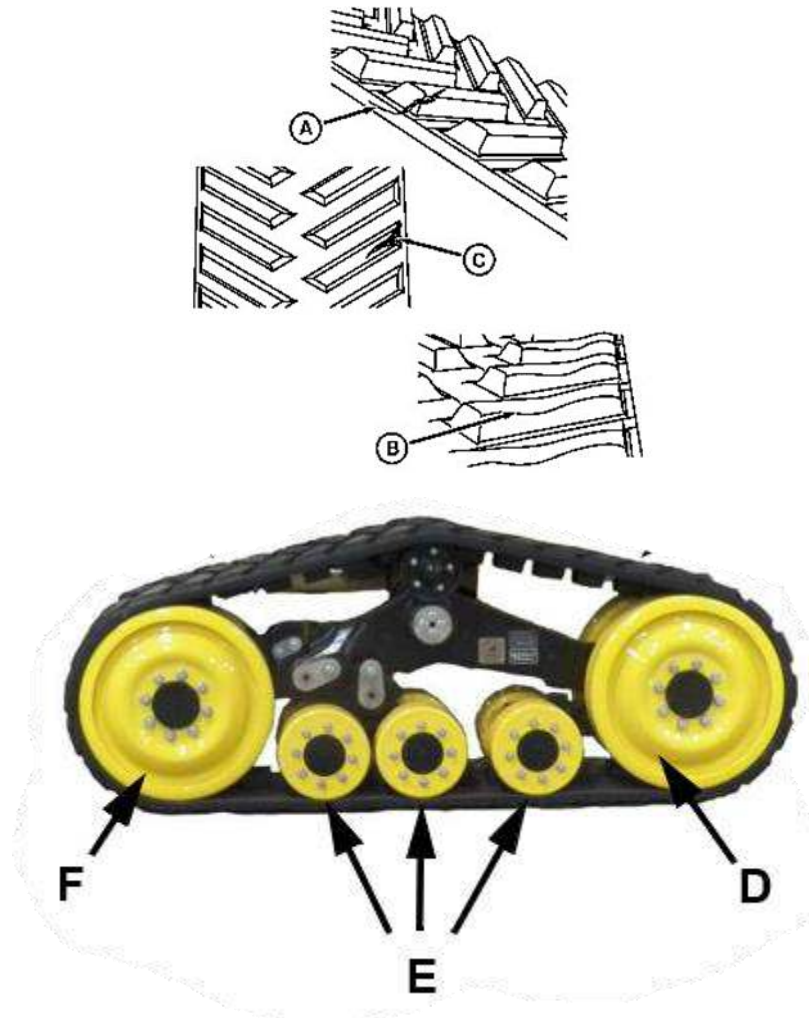

Trash build-up can cause fire from increased friction. Remove trash from trash build-up points (G) between track and applicator frame.

Inspect for cracking (A), uneven wear (B) and/or chipping or chunking (C) on rubber surfaces of drive wheels (D), mid-rollers (E) and idler wheels (F).

Remove any embedded rocks, nails, or other sharp object in track belt or mid-rollers.

Undercarriage Inspection and Maintenance

Perform required lubrication. (See [LUBRICATION](#) and [MAINTENANCE](#) section.)

Inspect for loose, damaged, or missing parts. Repair or replace parts before entering the field.

1. Remove any debris or material buildup on the tops of frame reaction arms. Buildup can wear down rubber on wheels.

2. Check for material buildup between mid-wheels and idler wheels. Buildup can damage or crush guide lugs and can increase chances of derailing the track. If guide lug tip damage is seen, it may be due to material buildup.
3. Look over mid rollers and idler wheels for visible cracks around the bolt pattern or the rim. If seen, contact your Fast Ag Solutions dealer for the best recommendation of repair or replacement.

Track Service

Service Task	Service Action
Track Wear	Check
Track Alignment	
Track Tension	
Idler Wheels and Mid-Rollers	
Track Trash Buildup	
Mid-Rollers Oil Level	
Idler Wheel Hub Oil Level	
Idler Wheel and Mid-Roller Cap Screws	Tighten

Mid-Wheel, Wedges, Idler, and Mid-Roller Cap Screws

If the DuraPlacer is operated with loose cap screws, they may become worn and it may be necessary to replace them.

Re-tighten track cap screws after working 3 HOURS, 10 HOURS and DAILY during the first week of operation.

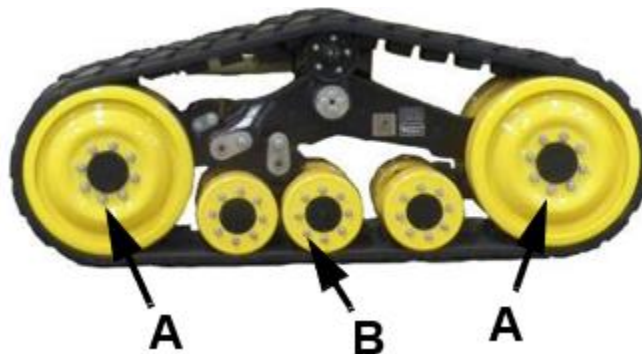

Inspect and re-torque idler wheel (A) and mid-roller (B).

Screws	Torque
M16 Idler Wheel Cap	320 N-m (236 ft-lbs.)
M20 Mid-Roller Wheel Cap	620 N-m (457 ft-lbs.)

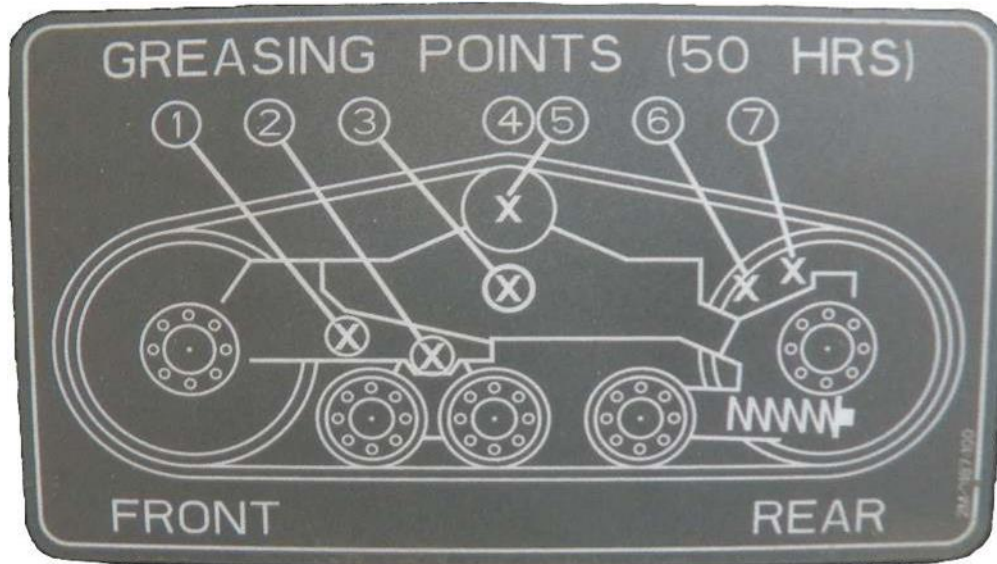

Check Track Alignment

1. Prior to checking track alignment, the implement should be empty and spring tensioning mechanism set properly with no pre-load.
2. Pull the implement on a flat surface for a suitable timeframe allowing the belts to relax and move freely on the undercarriage rollers.
3. Drive in a straight line for roughly 200 ft and coast the tractor to a stop. Place the tractor in PARK and apply the emergency brake. Do not apply braking action during this process as sudden stops can affect track position during the alignment process.
4. Using a ¼" x 4" x 8" shim (A) slid between the front mid-roller and guide lugs (B). Bridge guide lugs with the shim maintaining pressure on a minimum of 2 lugs.

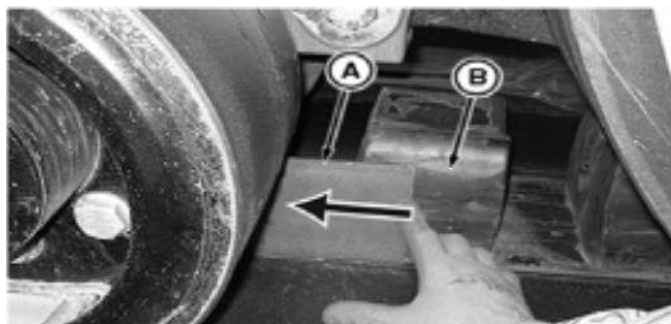

5. If the shim fits freely between the lugs and mid-roller on both sides of the undercarriage, the alignment is correct. If the shim binds and does not fit between the mid-rollers / guide lugs, track adjustment is necessary.

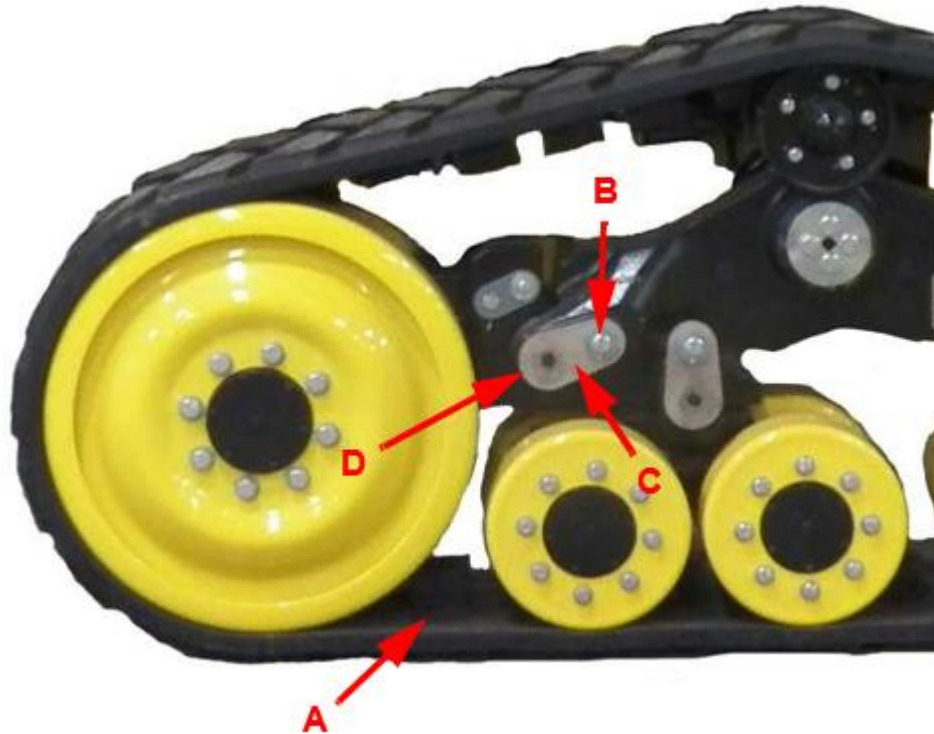

Track Alignment Procedure

1. Remove the alignment bolt retainer lock plate cap screws (B) and lock plate (C) from the inboard and outboard sides of the undercarriage needing adjustment.
2. Loosen cap screw (D) counterclockwise 1.0-1.5 turns on the side of the undercarriage you want the track to move towards (A represents location between inner idler wheel surface and guide lug).
3. Tighten the special cap screw on the opposite side of the same undercarriage to 300 N-m (221 ft-lbs.). Tighten cap screw loosened in Step 2 to the same specification.
 - a. A single full turn is the standard increment during adjustment. Lessen this amount as final adjustment is approached.
4. Re-check track alignment and adjust until suitable clearance is obtained on both sides of the guide lugs.
 - a. Lock plates are reversible for double the index increments.
 - b. If needed, increase torque on the special cap screw slightly allowing advancement to a suitable lock plate position.
5. When alignment is complete, reinstall the lock plates and tighten cap screws to their required torque specification of 130 N-m (95 ft-lbs.).

ATTACHING and DETACHING

Attach the Machine Safely

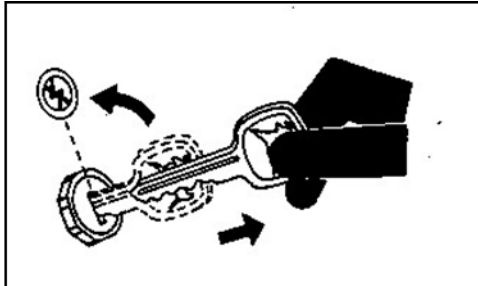

⚠ CAUTION: Prevent personal injury caused by unexpected movement of the machine. Engage the tractor's parking brake and/or place transmission in PARK, shut off the engine, and remove the ignition key before working around the hitch.

Attach the Machine to the Tractor

⚠ CAUTION: Make sure that all bystanders are clear of the working area.

1. Make sure there is enough room and clearance to safely back up to the machine.
2. Slowly back the tractor until holes on the hitch and drawbar are aligned.
3. Install drawbar pin and retainer.
4. Attach safety chain (see [Attach Safety Chain to Tractor](#)) securely around tractor drawbar cage to prevent unexpected separation.
5. Check that DuraPlacer hydraulic system is compatible with the tractor's hydraulics: [Hydraulic System Requirements](#). Change the choice of DuraPlacer model if required. Do not operate unless tractor and applicator hydraulics are compatible.
6. Connect Hydraulics



⚠ WARNING: Prevent serious injury or death. Relieve hydraulic system pressure before connecting hydraulic hoses.

- a. Use a clean rag or paper towel to clean dirt from couplers on hose ends and tractor couplers.
 - b. Relieve pressure in the hydraulic system.
 - c. Route hoses over the hitch and connect hoses to tractor couplers. Verify couplers are securely seated. See [SCV Identification Chart](#) for hose connections.
 - d. Be sure to provide slack for turning.
7. Route electrical lines over the hitch and connect to the tractor's electrical connectors. Be sure to provide slack for turning.

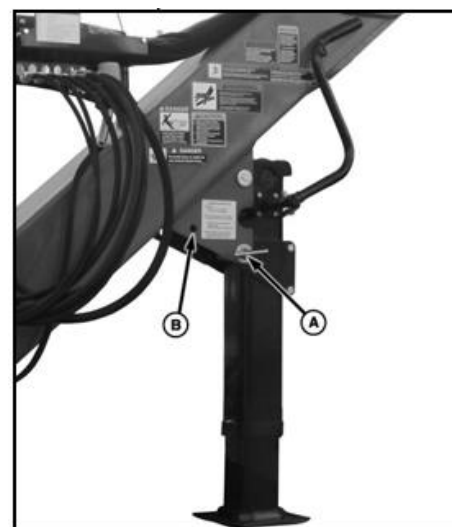

A - Pin

B - Hole

- Pull pin (A) out and pivot the jack frame forward into its stowed position. Insert pin in hole (B) to secure the jack.

Attach Safety Chain to Tractor

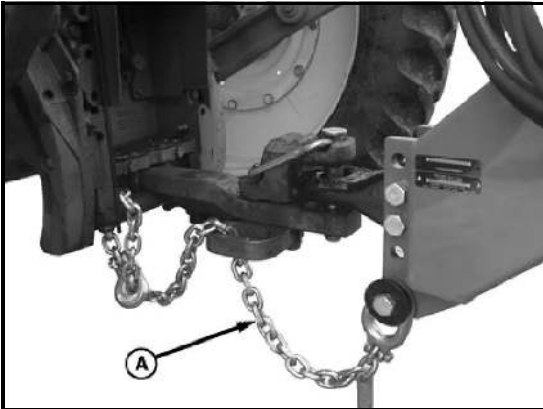

A - Safety Chain

! CAUTION: A safety chain (A) will help control drawn equipment should it accidentally separate from the drawbar while transporting. A runaway machine can cause serious injury or death to you or others. Using appropriate adapter parts, attach the chain to the tractor's drawbar support. Provide only enough slack in chain to permit turning.

See your Fast Ag Solutions dealer for a safety chain with a strength rating equal to or greater than the gross weight of towed machine.

Prior to operating the implement, ensure all electrical harnesses, hydraulic hoses, and safety chain are routed properly to avoid damage.

When storing the machine, keep the safety chain up off the ground and hook it to the machine support assembly on the hitch. Always replace a safety chain if one or more links or end fittings are broken, stretched, or otherwise damaged.

Verify all chains for towed implements are adequately sized for safe transport.

Attach Warning Light Plug

! CAUTION: When transporting the machine on a road or highway at night or during the day, use warning lights and devices for adequate warning to operators of other vehicles. For this matter, check local governmental regulations.

Various safety lights and devices are available from your Fast Ag Solutions dealer.

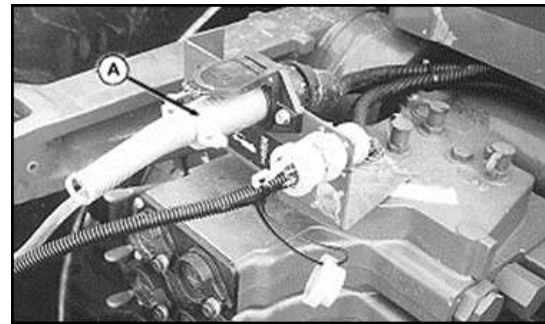

A. 7-Pin Connector Warning Light Plug

Attach a warning light plug (A) to the tractor's outlet socket.

Be sure warning lights, reflectors, and SMV emblem(s) are clean.

Connect Rate Controller or Nutrient Applicator System Wiring

See manufacturer's Manuals for connecting controller cables to the tractor.

Make Proper Hose Connections



⚠ WARNING: Escaping fluid under pressure can penetrate the skin and cause serious injury. Avoid the hazard by relieving pressure before disconnecting any hydraulic or other pressurized lines. Tighten all connections before applying pressure. Search for leaks with a piece of cardboard. Protect hands and body from high-pressure fluids.

If an accident occurs, see a doctor immediately. Any fluid injected in the skin must be surgically removed within a few hours or gangrene may result. Doctors unfamiliar with this type of injury should reference a knowledgeable medical source. Such information is available from Deere & Company Medical Department in Moline, Illinois, U.S.A.

⚠ IMPORTANT: Hydraulic hoses can fail due to physical damage, kinks, age, and exposure. Check hoses regularly. Replace damaged hoses.

⚠ IMPORTANT: All hydraulic couplers must be clear of debris, dust, and sand. Use protective caps on fluid openings until ready to make connection. Foreign material can damage the hydraulic system.

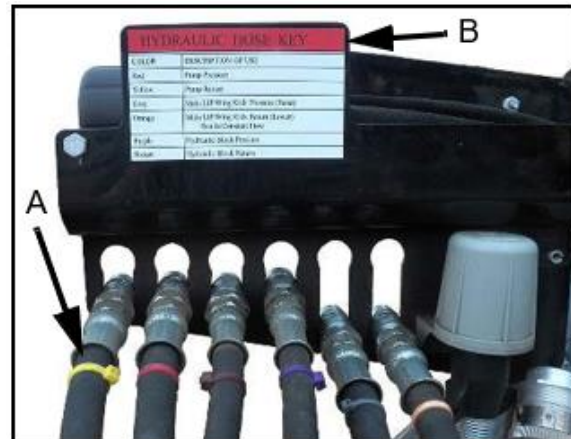

- A. SCV Marker
- B. Hose Key Chart

Identify the SCV marker color (A) and then use the hose key chart (B) to connect to the correct SCV outlet. (See [SCV Identification Chart](#))

Make sure the quick couplers are fully engaged. If the quick couplers do not fully engage, check to see that the couplers are the same size and type.

SCV Identification Chart

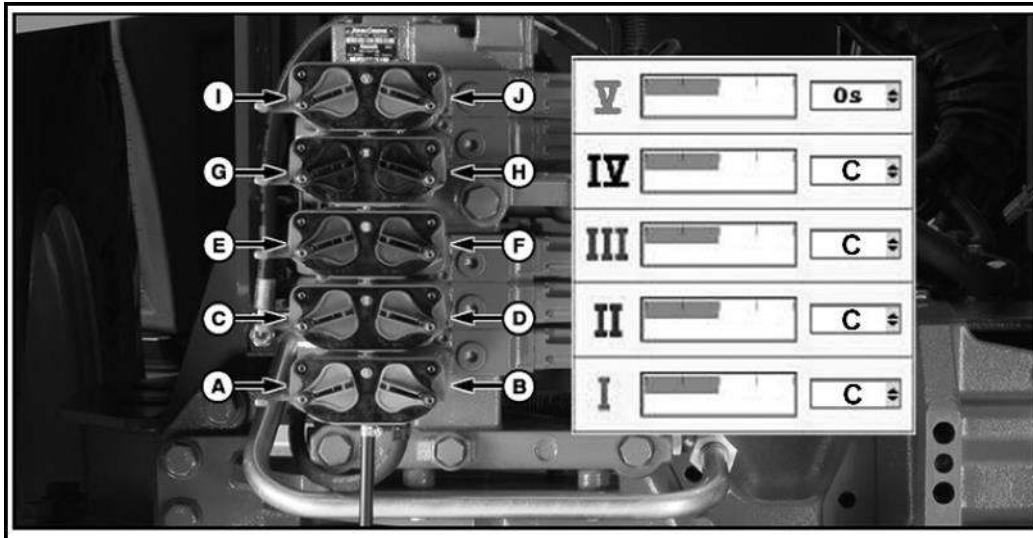

Legend	SCV ID	Tractor Flow Type	Hose Color	SCV Function
A	I	Return	Gray	Raise Main Lift (Base End) / Wing Kick (Rod End)
B	I	Pressure	Orange	Lower Main Lift (Rod End) / Wing Kick (Base End)
C	II	Return	Brown	Hydraulic Manifold Return
D	II	Pressure	Purple	Hydraulic Manifold Pressure
E	III	Return	Yellow	Hopper System Return
F	III	Pressure	Red	Hopper System Pressure
G	IV	Return	Black	Raise Hitch (Rod End)
H	IV	Pressure	White	Lower Hitch (Base End)
I	V	Return	Orange - Orange	Metering Return
J	V	Pressure	Grey - Grey	Metering Pressure
-	-	Drain	Blue	Hopper System Case Drain

⚠ IMPORTANT: Hose colors do not match SCV color

See [Hydraulic System Requirements](#) for system compatibility.

Detach Machine from Tractor



A - Pin

B - Hole

1. Secure jack as shown using pin (A).

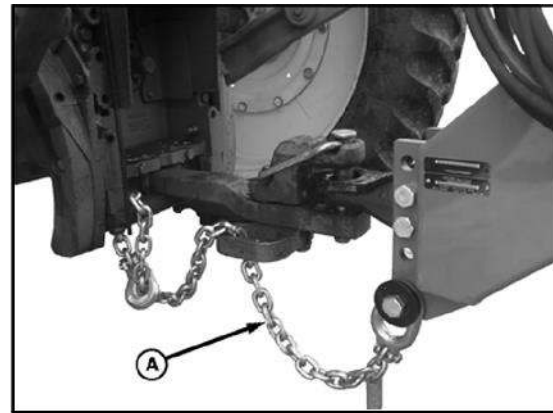

Figure 4: Wiring Harness and Hoses in Storage Position

2. Disconnect wiring harness and place in storage position.

⚠️ WARNING: Prevent serious injury or death. Relieve hydraulic system pressure before disconnecting hydraulic hoses.

3. Disconnect hydraulic hoses and place them in their storage position.



A - Safety Chain

4. Disconnect safety chain (A).

Adjust Hitch Height

Verify machine is parked safely before performing hitch adjustment to avoid injury or death caused by uncontrolled machine movement.

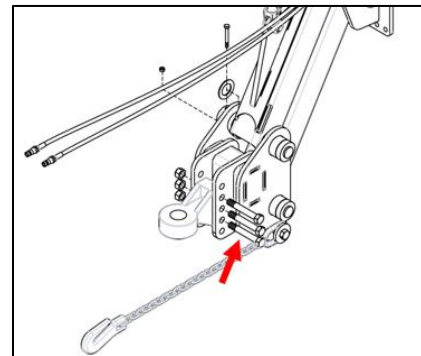

1. Remove and retain hex bolts and nuts.
2. Lower hitch assembly and retain using an appropriately sized stand or strap.
3. Reinstall the hex bolts and nuts with the hitch at the desired position.
4. Tighten the hex bolts to 873 N-m (644 ft-lbs.)

TRANSPORTING

Following Safe Transport Procedures

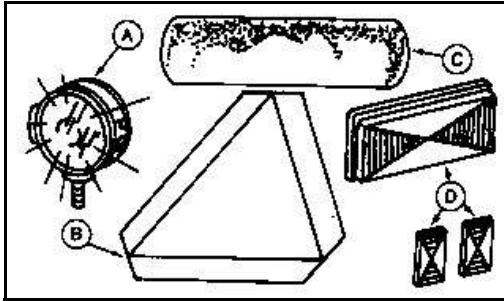

- A. Lights
- B. SMV Emblem
- C. Reflector Tape
- D. Reflectors

! CAUTION: When transporting the machine on a road or highway at night or during the day, use warning lights and devices for adequate warning to operators of other vehicles.

! IMPORTANT: Transport DuraPlacer only with tank **EMPTY** to prevent DuraPlacer damage.

Check local governmental regulations.

Various safety devices are available from your Fast Ag Solutions dealer. Keep safety items in good condition. Replace missing or damaged items.

Upward force on hitch may cause instability when transporting. Add **BALLAST** to tractor as required.

BEWARE of overhead wires and narrow gates. **KNOW** the transport height and width of your machine. (See [Machine Dimensions & Specifications](#).)

Travel at a reasonable and safe speed; **REDUCE** speed over rough or uneven terrain, slopes, and when turning. See [Observe Maximum Transport Speed](#).

BE SURE SMV emblem, reflectors, and warning lights are clean, visible, and in good condition.

BE SURE your safety chain has a strength rating greater than the gross weight of the machine.

Preparing the Machine for Transport

Fold Toolbar for Transport

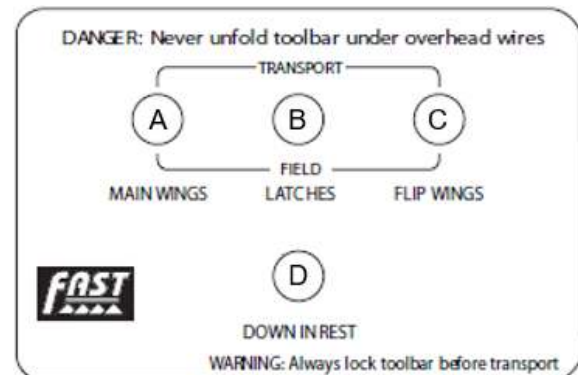

- A. Main Wings Toggle Switch
- B. Latches Toggle Switch
- C. Flip Wings Toggle Switch
- D. Down in Rest Toggle Switch

1. Pull SCV I backward to raise toolbar and kick wings up.
2. Push SCV II forward in continuous mode to supply oil to the fold valve functions.
3. Hold flip wings toggle switch (C) to transport position until flip wings are fully folded (if equipped.)
4. Move and hold latches switch (B) to transport position to engage the hitch/tongue latch.
5. Hold down the rest switch (D) until main wings are fully lowered on rest.
6. Move and hold latch switch (B) to Field Position until transport latches fully engage.
7. Disengage SCV II and install transport cylinder locks on both main lift cylinders.

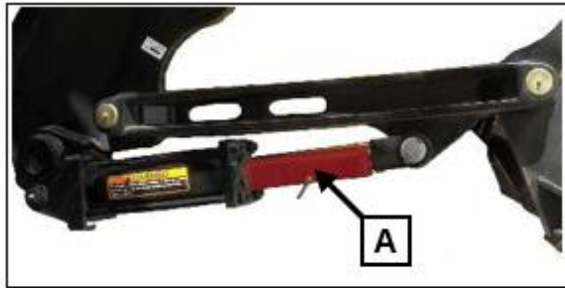

A - Cylinder Transport Lock (2 Used)

- ⚠ CAUTION:** Be sure all bystanders are clear of the DuraPlacer.
- ⚠ IMPORTANT:** Transport DuraPlacer only with tank **EMPTY** to prevent DuraPlacer damage.
- ⚠ CAUTION:** See [Observe Maximum Transport Speed](#) in the Safety section for towing information.

Transport Notes and Checks

Be sure that the DuraPlacer is properly connected to the tractor. Always attach a safety chain between the DuraPlacer and the tractor and install a retainer through the drawbar pin.

Ensure that the hitch/tongue latch is fully engaged.

Install cylinder locks (A) on main lift cylinders before transporting.

- ⚠ NOTE:** Add more spacers if needed to ensure the tool bar is fully raised and stays fully raised.

Transporting the Machine

Using Warning Lights

CAUTION: When transporting the machine on a road or highway at night or during the day, use accessory lights and devices for adequate warning to operators of other vehicles. Check local governmental regulations.

Various safety lights and devices are available from Fast Ag Solutions dealer. Keep safety items in good condition. Replace missing or damaged items.

During periods of limited visibility, use pilot vehicles and use extra lights on the machine.

During normal transport, both amber warning lights will flash in unison at high intensity and both red lamps will illuminate steadily at low intensity.

When a turn is signaled, red and amber tail lamps in the direction of turn will flash at high intensity and in unison. On the opposite side, amber and red lamps will illuminate steadily at high intensity.

Keep Riders Off the Machine

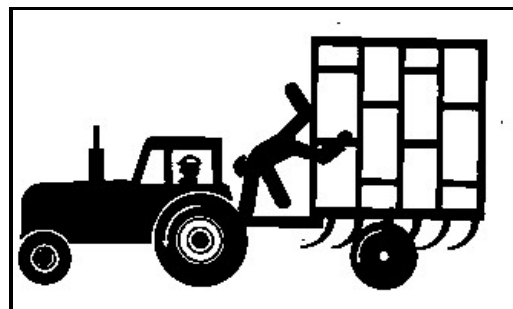

Riders are subject to injury such as being struck by foreign objects and being thrown off the machine. Riders obstruct the Operator's view resulting in the machine being operated in an unsafe manner.

Caution for All Machines

⚠ CAUTION: When transporting the machine on a smooth surface road, do not exceed the maximum transport speed of 32 km/h (20 MPH). Reduce speed considerably when traveling over rough ground.



Reduce speed when turning. Do not uncouple tractor brake pedals and apply individually in an attempt to make a tighter turn.



Serious injury or death can result from contact with electric lines. Use care when moving or operating this machine near electric lines to avoid contact. Know transport height and width of machine. Check local regulations before transporting. (See [Machine Dimensions & Specifications](#) for transport height and width of machine.)

Transport with wings fully folded. Never raise or lower the center section or wings when moving. After folding, ALWAYS place the fold valve (SCV II) in the neutral position for transport.

If wing-fold cylinders are removed or damaged, chain wings together to prevent injury or death caused by accidental falling of wings on you or others.

Unfolding/Extending the Toolbar



⚠ WARNING: Prevent serious injury or death. The machine coming near or contacting power lines can cause electrocution. Electrocution can occur without contact. Fully lower wings before moving or transporting.

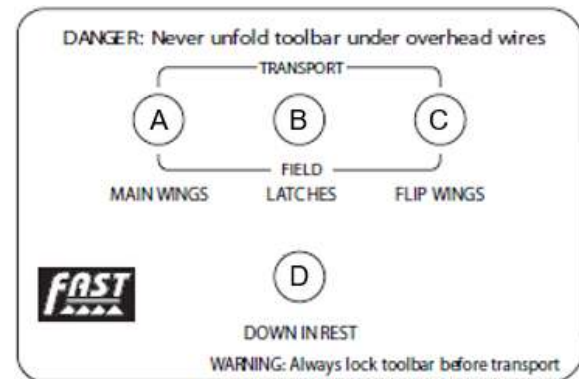

- A. Main Wing Toggle Switch
- B. Latches Toggle Switch
- C. Flip Wings Toggle Switch
- D. Down in Rest Toggle Switch

1. Pull SCV I backward to raise the center section and inner wings.
2. Verify tool bar is fully raised.
3. Remove and store the cylinder locks from the main lift cylinders.
4. Push SCV II forward to detent to supply continuous oil flow to fold valve functions.
5. Move latches switch (B) to transport position and hold until transport latches are completely disengaged.
6. Move main wings switch (A) to Field Position and hold until wings are unfolded. Wings will be laterally in-line with the center section when fully unfolded.

Unfolding/Extending the Toolbar (continued)

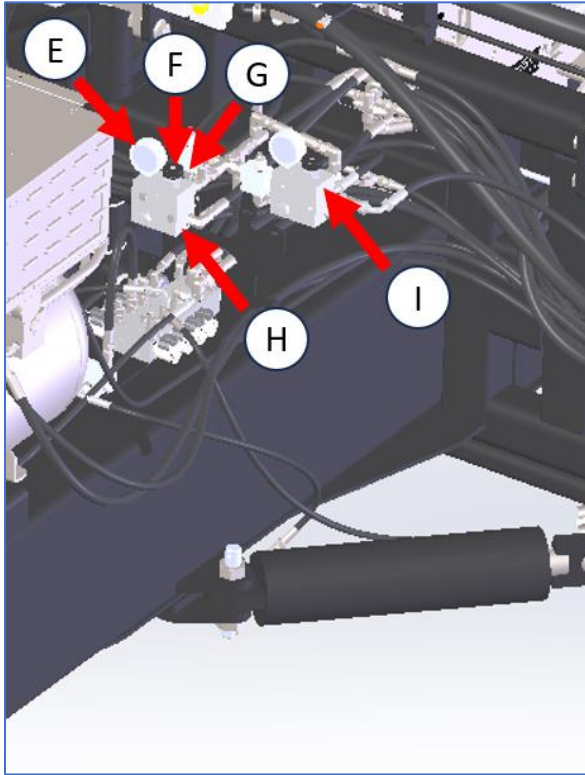

- E. Gauge
- F. Knob
- G. Lock Ring
- H. Down Pressure Valve for Main Wings
- I. Down Pressure Valve for Flip Wings
(if equipped)

7. Move latch switch (B) to engage the hitch latch.
8. Move flip wing switch (C) to Field Position and hold to unfold flip wings.
9. SCV II may now be disengaged and returned to the neutral position until a wing folding function is required.
10. Check the amount of down pressure to inner wings by lowering the row units to the ground while sitting still and setting SCV I to continuous down.
 - a. Hydraulic down pressure gauge (E) should read between 700 and 1000 psi but see Step 11 below.
 - b. Down pressure may be adjusted by turning knob (F) on down pressure valve (H) but see Step 11 below.
11. Use only as much down pressure as needed to maintain a level toolbar and consistent coultter or disc penetration depth across the entire toolbar. Excess pressure could cause damage to the toolbar.
 - a. Turn knob clockwise to increase pressure and counterclockwise to decrease down pressure.
 - b. To change pressure, loosen lock ring (G) and turn adjustment knob a 1/4 turn at a time.
 - c. **Do not exceed 1500 PSI.**
12. Pull SCV I backward to fully raise toolbar and kick wings up.
13. Toolbar is now ready for field application.

HYDRAULIC FLOW

Regulating Hydraulic Flow to the Pump

Locate your tractor model and follow the appropriate setup instructions.

⚠ WARNING: FAILURE TO REGULATE OIL FLOW WILL CAUSE MOTOR FAILURE.

⚠ WARNING: NOT SUITABLE FOR PUMPING FLAMMABLE LIQUIDS.

Load Sensing Closed Center System (LS Closed)

Regulate oil flow with the tractor's FLOW CONTROL and FLOW LIMITER. (Do not use restrictor orifice.)

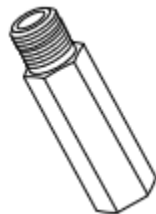

Figure 5: Flow Limiter

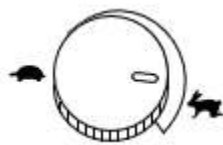

Figure 6: Flow Control

Setup Instructions:

1. (Optional) Remove adapter and install flow limiter in motor inlet port (marked I).
2. Close motor needle valve: loosen jam nut, screw needle valve clockwise until seated, and lock jam nut (factory setting.)
3. Shut off toolbar boom and agitation valves if equipped.
4. Adjust tractor flow control to minimum flow setting (Turtle).

5. Move hydraulic lever to "Lower/Retract" position to start pump.
6. Adjust tractor flow control until the toolbar shut-off (deadhead) pressure is within the pump's operating parameters. **Note:** If the flow limiter stops oil flow to the motor:
 - a. Move hydraulic lever to "Float" or "Neutral" to remove oil pressure from the flow limiter.
 - b. Adjust tractor flow control to a lower flow position.
7. Repeat steps 5 and 6.
8. Open the agitation valve(s).

Pressure Compensating Closed-Center System (PC Closed)

Regulate oil flow by using a RESTRICTOR ORIFICE. (Do not use flow limiter.)

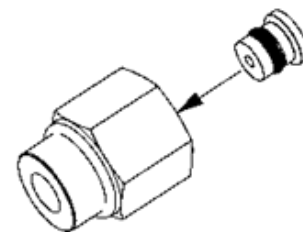

Figure 7: Restrictor Orifice

Setup Instructions:

1. Install restrictor orifice by inserting inside the adapter/restrictor body in the motor inlet port (marked I).
2. Close motor needle valve: loosen jam nut, screw needle valve clockwise until seated, and lock jam nut (factory setting.)
3. Set "Rabbit/Turtle" flow control to "Turtle".
4. Move hydraulic lever to the "Lower/Retract" position to start pump.
5. Adjust "Rabbit/Turtle" flow control and agitation valve(s) to get desired injection pressure.

Open Center System (Open)

Select motor size closest to tractor's hydraulic system capacity. Regulate oil flow with motor NEEDLE VALVE.

(Do not use restrictor orifice or flow limiter.)

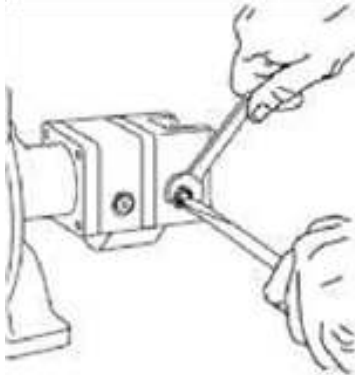

Figure 8: Closing the Needle Valve

Setup Instructions:

1. Shut off sprayer boom and agitation valves.
2. Loosen jam nut on motor and back out needle valve 3 or 4 turns counterclockwise.
3. Set tractor throttle to sprayer operating speed.
4. Move hydraulic lever to "Lower/Retract" position to start pump.
5. Screw needle valve clockwise until sprayer (deadhead) pressure is within the pump's operating parameters and lock the jam nut.
6. Open the sprayer agitation valve to get desired injection pressure.

Tractor SCV Functions

See [SCV Identification Chart](#) for connections.

NOTE: The illustrations in this Manual are for explanatory purposes only. Your control system may differ in appearance and function.

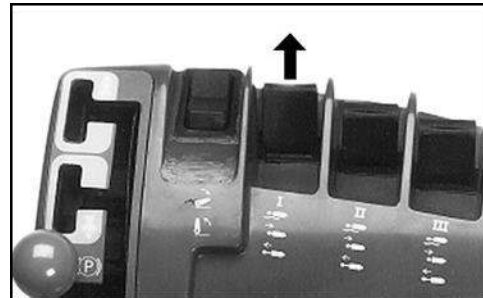

Figure 9: SCV I Pushed Forward

When the tractor's SCV I is pushed forward, the following functions are enabled:

1. Lowers main lift,
2. Lowers wings,
3. Lowers wing kicks, and
4. Engages down-pressure.

CAUTION: The SCV I function must be left pushed forward whenever the toolbar is in the ground.

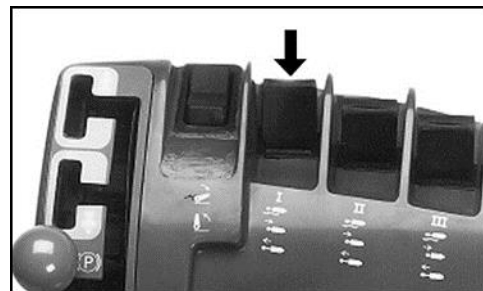

Figure 10: SCVI Pulled Backward

When the tractor's SCV I is pulled backward, the following functions are enabled:

1. Raises main lift,
2. Raises wings, and
3. Raises wing kicks.

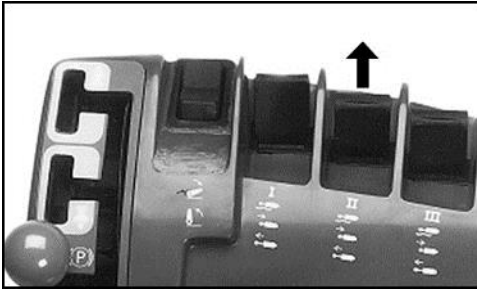

Figure 11: SCV II Pushed Forward

When the tractor's SCV II is pushed forward, the following functions are enabled:

1. Supplies hydraulic oil flow to operate implement folding functions.
2. When complete, tractor SCV II may be returned to neutral position.



Figure 14: SCV III in Float

When the tractor's SCV III is in float position, the following functions are enabled:

1. Disengages hopper system for transporting.

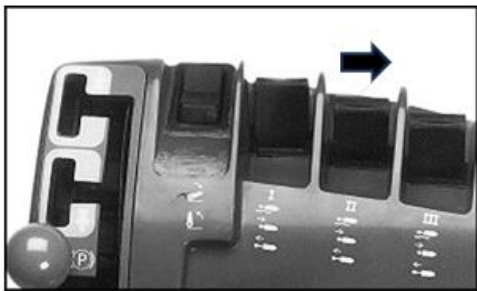

Figure 12: SCV II in Float

When the tractor's SCV II is in float position, the following functions are enabled:

1. Turns off hydraulic block pressure.



Figure 15: SCV IV Pushed Forward

When the tractor's SCV IV is pushed forward, the following functions are enabled:

1. Lowers hitch/pintle.

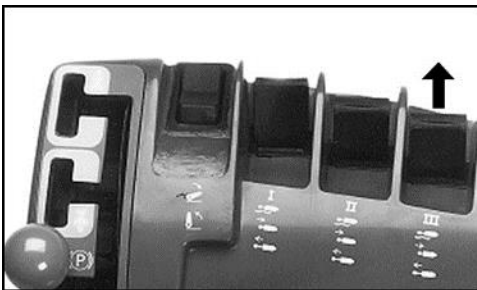

Figure 13: SCV III Pushed Forward

When the tractor's SCV III is pushed forward, the following functions are enabled:

1. Engages hopper system for applying.



Figure 16: SCV IV Pulled Backward

When the tractor's SCV IV is pulled backward, the following functions are enabled:

1. Raises hitch/pintle.



Figure 17: SCV V Pushed Forward

When the tractor's SCV V is pushed forward, the following functions are enabled:

1. Engages metering system.



Figure 18: SCV V in Float

When the tractor's SCV V is in float position, the following functions are enabled:

1. Disengages metering system.

Down Pressure (Kick) Orifice Adjustment

The extension rate of the down pressure (kick) cylinders can be adjusted via two adjustable orifice one-way needle valves.

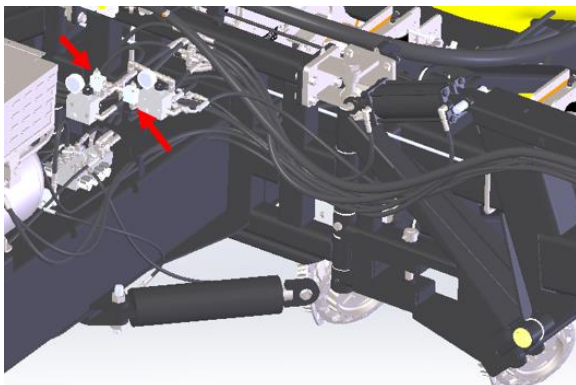

If the toolbar's main wings do not contact the ground when getting into Field Position as

the toolbar's center section does, adjustment should be made on these valves.

1. Verify that the main lift hydraulic flow setting in the tractor is set to 9 or 90%. If set correctly and problem persists, proceed to Step 2.
2. Unfold the toolbar into field position and lower the toolbar fully to the ground.
3. On the adjustable orifice valves, loosen jam nut with an 11/16" box wrench.
4. Using a 1/4" Allen wrench, turn the adjuster screw in (clockwise) a 1/4 turn to slow down the wing speed or out (counterclockwise) a 1/4 turn to speed up the wing speed. Do this to both valves.
5. Raise the toolbar fully, then lower the toolbar to see if the entire toolbar hits the ground at the same time.
6. Continue to adjust the set screws until the toolbar lowers evenly.
7. Tighten the jam nuts when finished.



<https://youtu.be/xxbfBXLgabE>

ADJUST DEPTH CONTROL

Adjust Application Depth

Depth of material placement can vary depending on the type of application. Check with the fertilizer or chemical manufacturer for information regarding application depth. Set toolbar, coulter/disc, or nozzle to required depth.

Once the desired field location of the application is reached, the center section and main wing kick may be lowered by pushing SCV I forward.

Even after coulters are in ground, SCV I must be constantly engaged to provide oil supply to and drain from down pressure circuit.

Failure to keep SCV I engaged and constant supply of oil flow to the down pressure system may result in coulters riding out of the ground and could result in structural failure of the toolbar and/or hydraulic cylinder components.

IMPORTANT: DO NOT exceed SCV I flow setting of 90%.

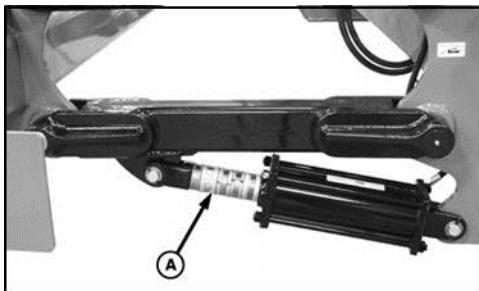

A. Spacer

Install spacers (A) on the toolbar lift cylinders' ram to give the required machine depth. The toolbar can then be fully lowered and always return to the same depth.

Adjust Gauge Wheels

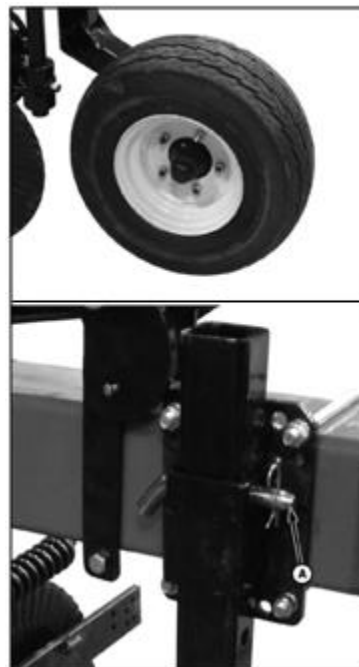

A. Pin

Each inner-wing and outer-wing is equipped with a gauge wheel that helps to maintain the application depth. Lower the gauge wheels if soil conditions are soft and raise if they are hard to obtain the same application depth.

1. Remove pin (A) and adjust gauge wheel height as desired.
2. Install pin and lock pin.
3. Repeat for the other side.

Adjust Row Unit Height

See [Yetter 2984 Strip Freshener Manual](#) for [complete instructions](#).





ADJUST GROUND SPEED

It will be necessary to establish a travel speed and then set the flow to give the desired application rate. Always run at the established travel speed.

However, the best results are obtained when the ground speed is 8 - 13 kph (5 - 8 mph). Ground speed variations in the field will automatically be compensated.

Always operate at a comfortable speed. Do not operate so quickly that the toolbar, trailer, or tank bounces while going through the field.

Effective results require that product be applied at a consistent depth in a consistent manner. Machine bouncing will prevent this required consistency.

PREPARING THE HOPPER SYSTEM

documentation relevant to the machine in use.



! CAUTION: Prevent serious injury or death

Check the chemical or fertilizer M/SDS for proper handling instructions.

Toxic chemicals can enter the body by breathing spray or contact with bare skin.

Do not take a chance with your health and safety.

Manufacturer-specific Documentation

Documents pertinent to and available for the Dry DuraPlacer at time of publication can be provided by your Fast Ag Solutions dealer.

- [Montag Gen II 2224 Customer Care Kit](#)
- [Montag Gen II Operations Manual](#)



The Operator must be familiar with all the instructions and information contained in the

Prepare the Tank

! CAUTION: Clear the area of bystanders, especially small children, and remove foreign objects from the machine and working area.

Ensure that all gates, doors, and other openings allowing for product drainage or movement out of the tank are closed. If using a Montag system, the method of controlling the tank's gate is as shown in Figure 19 and Figure 20.



Figure 19: Montag Gate closed position.



Figure 20: Montag Gate open position.

FILLING THE HOPPER TANK (BIN)



! CAUTION: Prevent serious injury or death.

Check chemical or fertilizer M/SDS for proper handling instructions.

Toxic chemicals can enter the body by breathing spray or contact with bare skin.

Do not take a chance with your health and safety.

Filling the Tank

! IMPORTANT: Transport the machine with an **EMPTY** tank to prevent machine damage.

! NOTE: The tank must be level for accurate volume readings. Use the hydraulic hitch option to raise or lower the front end of the trailer or refer to [Adjust Hitch Height](#) for further adjustment.

! CAUTION: Add only the amount of product to the tank that is required for the job.

1. Position a tender truck or a drive truck next to machine.
2. Open the fertilizer tank cover(s).

3. Install two screens (A) on top of the tank(s).

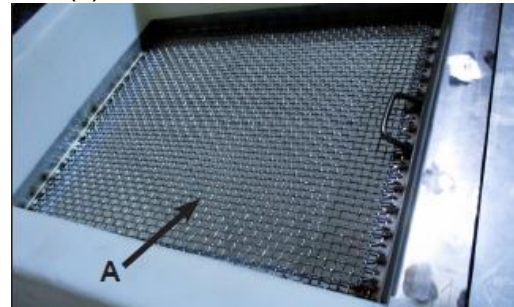

4. Stand on the platform and fill the tank with product.

! IMPORTANT: For low volumes, product may need to be manually leveled across the entire meter for consistent application.

! IMPORTANT: Moist product can plug the fertilizer or cover crop application system. Close the tank cover immediately after filling to prevent moisture from entering the system.

5. Close and latch the fertilizer tank cover(s).



FILLING THE HOPPER TANK (BIN)

Air Pressure Adjustment

See your specific tank's [Manufacturer-specific Documentation](#) for adjusting system air pressure.

General guidelines are provided below.

Air pressure is controlled by the hydraulic flow from the tractor to the unit. Ensure proper hydraulic flow and pressure are present before continuing with the adjustment. Check [Hydraulic System Requirements](#).

When determining air pressure needed for each product and rate, start on the high range and lower to appropriate level.

⚠ IMPORTANT: Too much air causes premature wear on air hoses, can cause product bridging, and requires more power. Not enough air will cause product blockage and damaged shear couplers.

Each application will vary depending on the use case. Some of the variables that affect the air pressure are flat rate versus prescription (range of rates), ground speed, number of row units, toolbar width, if splitters are used, density of the product, and hose routing.

Generally, the highest air pressure needed is 21 inches of water column (w.c.) down to 12 w.c. Most applications require air pressure somewhere in the middle. A good test is to start with a high pressure (20 w.c.) and start applying the highest rate and highest ground speed you will be operating at.

Ground Appl. Rate (lbs./acre)	Air Pressure (w.c.)
≤150	12-15
>150	15-21

It will look like mice running through the hoses. When this happens plugging can occur, so look at your air pressure reading and turn your air pressure up 1 to 2 w.c. higher. The product pulsing should go away, and the machine should be set for peak performance. If product or rates are changed, this air pressure should be monitored.

After a couple of rounds, start turning your air pressure down, and turn it down until you start seeing the product pulsing in the hoses.

LUBRICATION and MAINTENANCE

See these sections for component-specific maintenance:

- Tracks [Undercarriage Inspection and Maintenance](#)
- [Manufacturer-specific Documentation](#)

Lubricating and Maintaining the Machine Safely

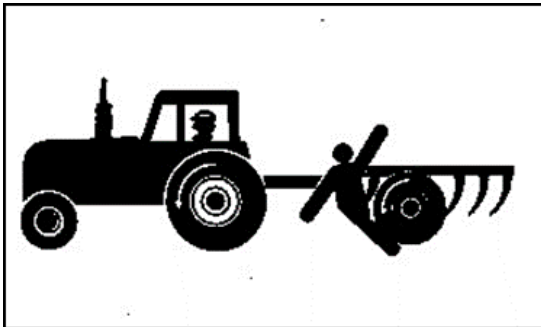

! CAUTION: To help prevent serious injury or death to you or others caused by unexpected movement, be sure to service machine on a level surface.

If the machine is connected to a tractor, engage the tractor's parking brake, place the tractor's transmission in PARK, shut off the engine, and remove its key. If the machine is detached from the tractor, block wheels and use safety stands to prevent movement.

Lubricant Storage

Equipment can operate at top efficiency only when clean lubricants are used.

Use clean containers to handle all lubricants.

Whenever possible, store lubricants and containers in an area protected from dust, moisture, and other contamination. Store containers on their side to avoid water and dirt accumulation.

Make certain all containers are properly marked to identify their contents.

Properly dispose of all old containers and any residual lubricant they may contain.

Grease

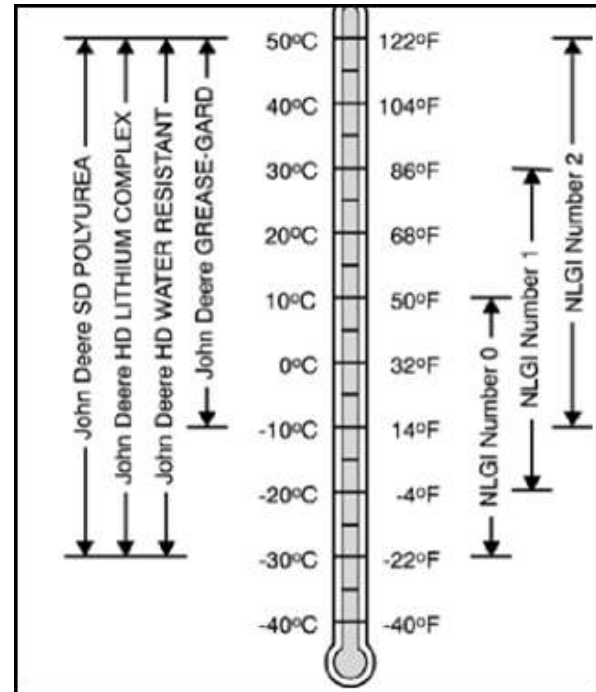

Greases for Air Temperature Ranges

Use grease based on NLGI consistency numbers and the expected air temperature range during the service interval.

! IMPORTANT: Some types of grease thickeners are not compatible with others. Consult your grease supplier before mixing different types of grease.

Alternative and Synthetic Lubricants

Conditions in certain geographical areas may require lubricant recommendations different from those printed in this Manual. Synthetic lubricants may be used if they meet the performance requirements as shown in this Manual.

The temperature limits and service intervals shown in this Manual apply to both conventional and synthetic lubricants.

Re-refined base stock products may be used if the finished lubricant meets the performance requirements.

Lubrication and Maintenance Intervals

Perform each lubrication and service illustrated in this section.

Each 10 hours or Daily

- Grease the Toolbar Parallel Linkages (both sides)

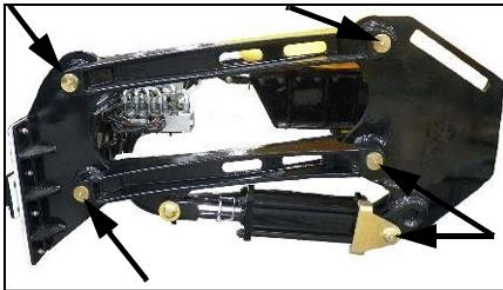

- Grease the Inner Wing Lift Pins (both sides)

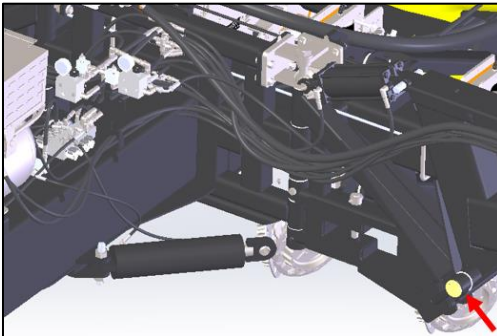

- Grease the Hitch



- Grease the Row Units' Actuation Points

- See [Yetter 2984 Strip Freshener Manual](#) for complete maintenance.

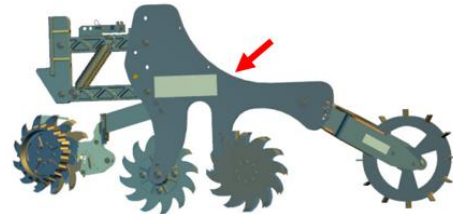

- Grease the Gauge Wheels



Each 50 Hours or Weekly

- Grease the Inner Wing Fold Pins (both sides)

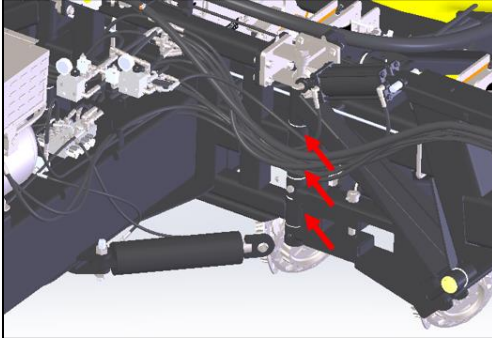

- Grease the Flip Wing Fold Hinge (both sides)

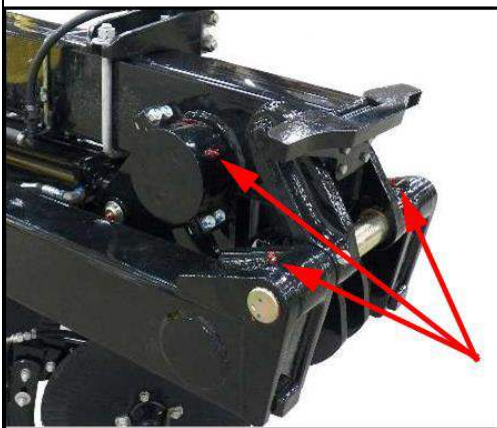
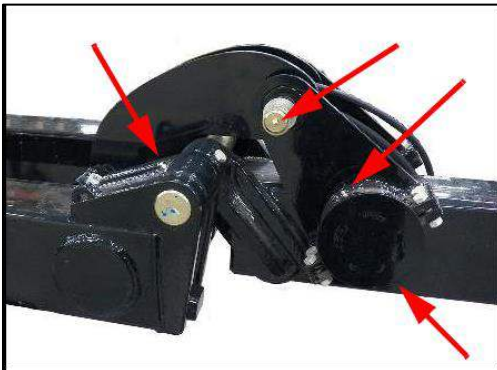

- Grease any slide gate knuckles.
- Grease any auger knuckles.
- Lubricate any roller chains with a lubricant that will not accumulate any dirt or debris.

Before and After Each Season

- Grease the Wheel Bearings

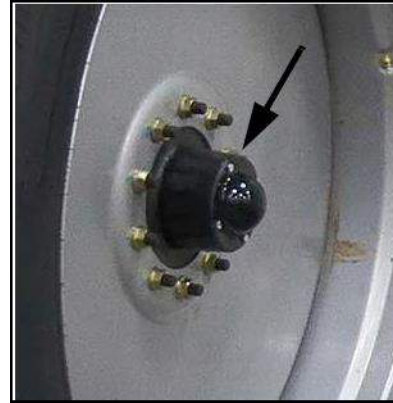

- Remove the Tongue Jack, remove the Top Cover (A) from the Jack, check the grease level, and reinstall the Top Cover and Jack.



- Inspect the shear couplers, chains, sprockets, slide gate, fan, augers, scale, caulking, and electrical components of the fertilizer tank.

As Required

Grease and lubricate the Mid Wheel, Wedges, Idler, and Mid-Roller Cap Screws with general-purpose grease at hourly interval indicated on their decal(s).

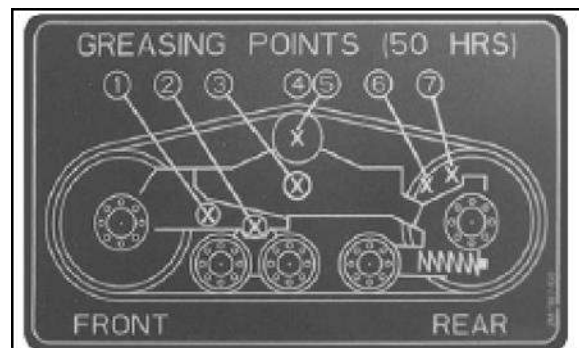

SERVICE**Practice Safe Maintenance**

Understand all service procedures before doing work. Keep the area clean and dry.

Never lubricate, service, or adjust the machine while it is moving. Keep hands, feet, and clothing away from power-driven parts. Disengage all power and operate controls to relieve pressure. Lower equipment to the ground. Stop the engine. Remove the key. Allow the machine to cool. Securely support any machine elements that must be raised for service work.

Keep all parts in good condition and properly installed. Fix any damage immediately. Replace worn or broken parts. Remove any buildup of grease, oil, or debris.

On self-propelled equipment, disconnect the battery ground cable (-) before making adjustments on any electrical systems or welding on the machine.

On towed implements, disconnect its wiring harnesses from the tractor before servicing any electrical system components or welding on the machine.

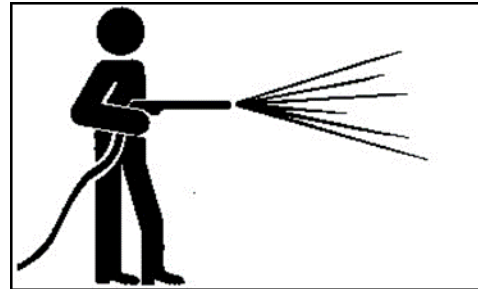
Work in a Clean Area

Before starting a job:

- Clean the work area and the machine.
- Make sure you have all the necessary tools to do your job.
- Have the right parts on-hand.
- Read all instructions thoroughly; do not attempt shortcuts.

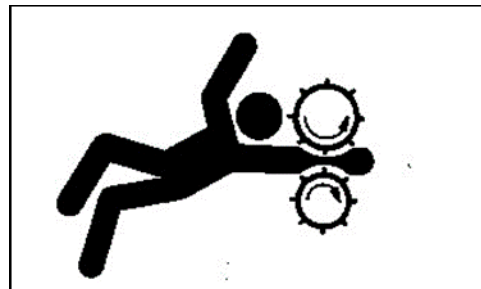
Service Machines Safely

Tie long hair behind your head. Do not wear a necktie, scarf, loose clothing, or necklace when you work near machine tools or moving parts. If these items were to get caught, severe injury could result.

Remove rings and other jewelry to prevent electrical shorts and entanglement in moving parts.

Support the Machine Properly



Always lower the attachment or implement to the ground before you work on the machine. If the work requires that the machine or attachment be lifted, provide secure support for them. If left in a raised position, hydraulically supported devices can settle or leak down.

Do not support the machine on cinder blocks, hollow tiles, or props that may crumble under continuous load. Do not work under a machine that is supported solely by a jack. Follow the recommended procedures in this Manual.

When implements or attachments are used with a machine, always follow safety precautions listed in the implement or attachment's Operator's Manual.

Avoid High-Pressure Fluids



Inspect hydraulic hoses periodically – at least once per year – for leakage, kinking, cuts, cracks, abrasion, blisters, corrosion, exposed wire braids, or any other signs of wear or damage.

Replace worn or damaged hose assemblies immediately with Fast Ag Solutions approved replacement parts.

Escaping fluid under pressure can penetrate the skin causing serious injury. Avoid the hazard by relieving pressure before disconnecting hydraulic or other lines. Tighten all connections before applying pressure.

Search for leaks with a piece of cardboard. Protect hands and body from high-pressure fluids.

If an accident occurs, see a doctor immediately. Any fluid injected into the skin must be surgically removed within a few hours or gangrene may result. Doctors unfamiliar with this type of injury should reference a knowledgeable medical source.

Preventing Hydraulic System Contamination

IMPORTANT: Cleanliness is very important when working on a hydraulic system. Prevent contamination by assembling cylinders, hoses, couplers, and valves in a clean area of the shop.

Leave protective caps on fluid openings until you are ready to make a connection. When charging the system, use a tractor or other source that contains clean oil free of abrasive materials.

Keep couplers clean. Abrasive particles, like sand or metal fragments, can damage seals, barrels, and pistons causing internal leakage.

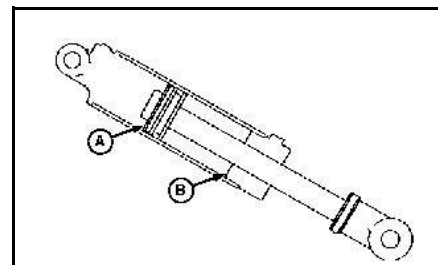

- A. Piston
- B. Rod Guide or Gland

⚠ IMPORTANT: To help keep couplers clean, always place them in a storage position when they are not attached to the tractor.

⚠ IMPORTANT: To prevent contaminants from entering the hydraulic system, filters must be installed at the tip of a supply hose. Additional filters are not recommended as they will restrict oil flow and adversely affect cylinder actuation time due to pressure drop.

Without a filter, large dirt particles can enter the cylinder and settle against the top side of piston (A) where they can cut the piston seal as the cylinder retracts.

Replace Hydraulic Hoses

⚠ WARNING: Avoid hazards due to escaping fluid under pressure. See [Avoid High-Pressure Fluids](#).

Hydraulic hoses between the lift cylinders and hydraulic lock-up valve should be inspected frequently for leakage, kinking, cuts, cracks, abrasion, blisters, corrosion, exposed wire braids, or any other signs of wear or damage.

Worn or damaged hose assemblies can fail during use and should be replaced immediately.

See your Fast Ag Solutions dealer for replacement hoses.

⚠ CAUTION: If an incorrectly rated hose is used, machine damage, injury, or death could occur.

If hoses are to be fabricated, ensure that the hoses are rated at no less than 82,737 kPa (827 bar) (12,000 psi) burst pressure according to SAE Standard J517, 100R17 hose specification.

Incorrect hose length or routing can increase the chance of hose wear or damage. Use the

old hose as a guide for length and hose routing.

Incorrect fittings can damage mating parts or cause leaks. Make sure to use steel fittings approved for use by the hose's manufacturer. Use the correct size and thread.

Make sure hydraulic hoses and harnesses do not interfere with moving parts. Relocate hoses and harnesses and retain them with clamps.

Tightening Hardware

Tighten all bolts to torques specified in [TIGHTENING HARDWARE](#) section unless otherwise noted.

Check tightness of hardware periodically.

PREPARING FOR STORAGE

⚠ CAUTION: Store the unit in an area away from human activity. Do not permit children to play on or around the stored DuraPlacer.

At the end of the season, thoroughly inspect and prepare the DuraPlacer for storage. Repair or replace any worn or damaged components to prevent any unnecessary downtime at the beginning of next season.

1. Follow the steps given by the tank's [Manufacturer-specific Documentation](#).
 - a. In general, removing all product from the system, ensuring all moisture is eliminated from the system, general part inspection is required.
 - b. Storing the system closed is highly recommended.
2. Drain and flush the system with air, then blow through any screens, valves, nozzles, check valves, and orifices/tips.
3. Thoroughly wash the machine using a pressure washer to remove all dirt, mud, debris, and residue to protect against corrosion.
4. Lubricate all grease points. Make sure all grease cavities have been filled with grease to remove any water residue from washing.
5. Inspect all hydraulic hoses, couplers, and fittings. Tighten any loose fittings. Replace any hose that is damaged or is separating from the crimped end of a fitting.
6. Inspect all chemical lines and connections. Tighten any loose fittings. Replace any line that is cut, nicked, or abraded.
7. Ensure all moisture is removed from the system.
8. Touch up all paint nicks and scratches to prevent rusting.

9. Fold inner and outer wings to the transport configuration.
10. Install spacers on the lift cylinder rams.
11. Move the machine to a storage position.
12. Select an area that is dry, level, and free of debris.
13. Place planks under the jack for added support if required.
14. Unhook DuraPlacer from tractor.

Removing from Storage

1. Clear the area of bystanders, especially small children, and remove foreign objects from the machine and working area.
2. Attach the tractor to the DuraPlacer.
3. Check:
 - a. Attach and secure all product lines.
 - b. Row Units and Nozzles.
 - c. All hardware. Tighten as required.
 - d. Tire pressure.
 - e. All hydraulic lines, fittings, and connections. Tighten as required.
4. Lubricate all grease fittings.
5. Replace any defective parts.
6. Add a small amount of product to the tank. Turn the metering pump on momentarily and check that product comes out of each nozzle/injector.
7. Follow the [Pre-Operation Checklist](#) before using.

TIGHTENING HARDWARE

Check the tightness of ALL BOLTS, U-BOLTS, and CAP SCREWS after the first 10-15 hours of operation and again at end of the first week (50 hours) of operation. Tighten all bolts to torques specified unless otherwise noted. Check tightness of hardware periodically.

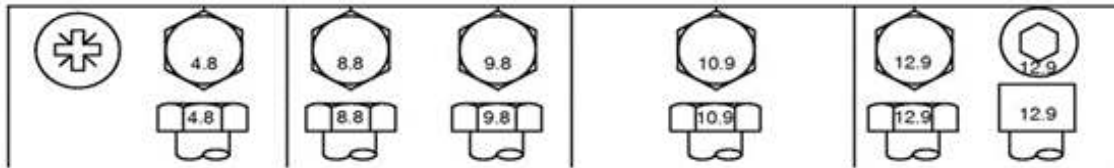

Figure 21: Common metric bolt grade markings

Metric Bolt and Screw Torque Values

Screw Size	Class 4.8				Class 8.8 or 9.8				Class 10.9				Class 12.9			
	Lubricated ¹		Dry ²		Lubricated ¹		Dry ²		Lubricated ¹		Dry ²		Lubricated ¹		Dry ²	
	N-m	lb.-in.	N-m	lb.-in.	N-m	lb.-in.	N-m	lb.-in.	N-m	lb.-in.	N-m	lb.-in.	N-m	lb.-in.	N-m	lb.-in.
M6	4.7	42	6	53	8.9	79	11.3	100	13	115	16.5	146	15.5	137	19.5	172
									N-m	lb.-ft.	N-m	lb.-ft.	N-m	lb.-ft.	N-m	lb.-ft.
M8	11.5	102	14.5	128	22	194	27.5	243	32	23.5	40	29.5	37	27.5	47	35
			N-m	lb.-ft.	N-m	lb.-ft.	N-m	lb.-ft.								
M10	23	204	29	21	43	32	55	40	63	46	80	59	75	55	95	70
	N-m	lb.-ft.														
M12	40	29.5	50	37	75	55	95	70	110	80	140	105	130	95	165	120
M14	63	46	80	59	120	88	150	110	175	130	220	165	205	150	260	190
M16	100	74	125	92	190	140	240	175	275	200	350	255	320	235	400	300
M18	135	100	170	125	265	195	330	245	375	275	475	350	440	325	560	410
M20	190	140	245	180	375	275	475	350	530	390	675	500	625	460	790	580
M22	265	195	330	245	510	375	650	480	725	535	920	680	850	625	1080	800
M24	330	245	425	315	650	480	820	600	920	680	1150	850	1080	800	1350	1000
M27	490	360	625	460	950	700	1200	885	1350	1000	1700	1250	1580	1160	2000	1475
M30	660	490	850	625	1290	950	1630	1200	1850	1350	2300	1700	2140	1580	2700	2000
M33	900	665	1150	850	1750	1300	2200	1625	2500	1850	3150	2325	2900	2150	3700	2730
M36	1150	850	1450	1075	2250	1650	2850	2100	3200	2350	4050	3000	3750	2770	4750	3500

Torque values listed are for general use only, based on the strength of the bolt or screw. DO NOT use these values if a different torque value or tightening procedure is given for a specific application. For stainless steel fasteners or for nuts on U-bolts, see the tightening instructions for the specific application. Tighten plastic insert or crimped steel type lock nuts by turning the nut to the dry torque shown in the chart, unless different instructions are given for the specific application.

Shear bolts are designed to fail under predetermined loads. Always replace shear bolts with identical property class. Replace fasteners with the same or higher property class. If higher property class fasteners are used, tighten these to the strength of the original. Make sure fastener threads are clean and that you properly start thread engagement. When possible, lubricate plain or zinc plated fasteners other than lock nuts, wheel bolts, or wheel nuts, unless different instructions are given for the specific application.

¹ "Lubricated" means coated with a lubricant such as engine oil, fasteners with phosphate and oil coatings, or M20 and larger fasteners with JDM F13C, F13F or F13J zinc flake coating.

² "Dry" means plain or zinc plated without any lubrication, or M6 to M18 fasteners with JDM F13B, F13E or F13H zinc flake coating.

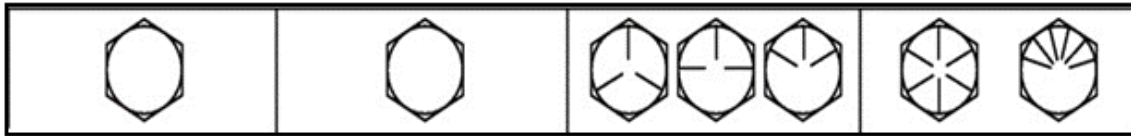

Figure 22: Common imperial bolt grade markings

Unified Inch Bolt and Screw Torque Values

Screw Size	SAE Grade 1				SAE Grade 2 ³				SAE Grade 5, 5.1 or 5.2				SAE Grade 8 or 8.2			
	Lubricated ⁴		Dry ⁵		Lubricated ⁴		Dry ⁵		Lubricated ⁴		Dry ⁵		Lubricated ⁴		Dry ⁵	
	N-m	lb.-in.	N-m	lb.-in.	N-m	lb.-in.	N-m	lb.-in.	N-m	lb.-in.	N-m	lb.-in.	N-m	lb.-in.	N-m	lb.-in.
1/4	3.7	33	4.7	42	6	53	7.5	66	9.5	84	12	106	13.5	120	17	150
													N-m	lb.-ft.	N-m	lb.-ft.
5/16	7.7	68	9.8	86	12	106	15.5	137	19.5	172	25	221	28	20.5	35	26
									N-m	lb.-ft.	N-m	lb.-ft.				
3/8	13.5	120	17.5	155	22	194	27	240	35	26	44	32.5	49	36	63	46
			N-m	lb.-ft.	N-m	lb.-ft.	N-m	lb.-ft.								
7/16	22	194	28	20.5	35	26	44	32.5	56	41	70	52	80	59	100	74
	N-m	lb.-ft.														
1/2	34	25	42	31	53	39	67	49	85	63	110	80	120	88	155	115
9/16	48	35.5	60	45	76	56	95	70	125	92	155	115	175	130	220	165
5/8	67	49	85	63	105	77	135	100	170	125	215	160	240	175	305	225
3/4	120	88	150	110	190	140	240	175	300	220	380	280	425	315	540	400
7/8	190	140	240	175	190	140	240	175	490	360	615	455	690	510	870	640
1	285	210	360	265	285	210	360	265	730	540	920	680	1030	760	1300	960
1-1/8	400	300	510	375	400	300	510	375	910	670	1150	850	1450	1075	1850	1350
1-1/4	570	420	725	535	570	420	725	535	1280	945	1630	1200	2050	1500	2600	1920
1-3/8	750	550	950	700	750	550	950	700	1700	1250	2140	1580	2700	2000	3400	2500
1-1/2	990	730	1250	930	990	730	1250	930	2250	1650	2850	2100	3600	2650	4550	3350
Torque values listed are for general use only, based on the strength of the bolt or screw. DO NOT use these values if a different torque value or tightening procedure is given for a specific application. For plastic insert or crimped steel type lock nuts, for stainless steel fasteners, or for nuts on U-bolts, see the tightening instructions for the specific application. Shear bolts are designed to fail under predetermined loads. Always replace shear bolts with identical grade.									Replace fasteners with the same or higher grade. If higher grade fasteners are used, tighten these to the strength of the original. Make sure fastener threads are clean and that you properly start thread engagement. When possible, lubricate plain or zinc plated fasteners other than lock nuts, wheel bolts, or wheel nuts, unless different instructions are given for the specific application.							

³ Grade 2 applies for hex cap screws (not hex bolts) up to 6 in. (152 mm) long. Grade 1 applies for hex cap screws over 6 in. (152 mm) long, and for all other types of bolts and screws of any length.

⁴ "Lubricated" means coated with a lubricant such as engine oil, fasteners with phosphate and oil coatings, or 7/8 in. and larger fasteners with JDM F13C, F13F or F13J zinc flake coating.

⁵ "Dry" means plain or zinc plated without any lubrication, or 1/4 to 3/4 in. fasteners with JDM F13B, F13E or F13H zinc flake coating.

Face Seal Fittings Assembly & Installation - All Pressure Applications

Face Seal O-Ring to Stud End Installation

1. Inspect the fitting surfaces. They must be free of dirt and defects.
2. Inspect the O-ring. It must be free of damage and defects.
3. Lubricate the O-rings and install them into the groove using petroleum jelly to hold them in place.
4. Push the O-ring into the groove with petroleum jelly so that the O-ring is not displaced during assembly.
5. Index any angle fittings and tighten by hand, pressing the joint together to ensure that the O-ring remains in place.
6. Tighten the fitting or nut to the torque value shown on the chart per dash size stamped on the fitting. DO NOT allow hoses to twist when tightening fittings.

Face Seal Adjustable Stud End O-Ring Installation

1. Back off the lock nut (jam nut) and washer to fully expose turned down section of the fitting.
2. Install a thimble over the fitting threads to protect the O-ring from nicks.
3. Slide the O-ring over the thimble into the turned down section of the fitting.
4. Remove thimble.

Face Seal Straight Stud End O-Ring Installation

1. Install a thimble over the fitting threads to protect the O-ring from nicks.
2. Slide the O-ring over the thimble into the turned down section of the fitting.
3. Remove thimble.

Fitting Installation

1. Install the fitting by hand until it is snug.
2. Position adjustable fittings by unscrewing the fitting no more than one turn.
3. Apply with an assembly torque per table.

Assembly Torque

1. Use one wrench to hold the connector body and one wrench to tighten the nut.
2. For a hydraulic hose, it may be necessary to use three wrenches to prevent twist: one on the connector body, one on the nut, and one on the body of the hose fitting.

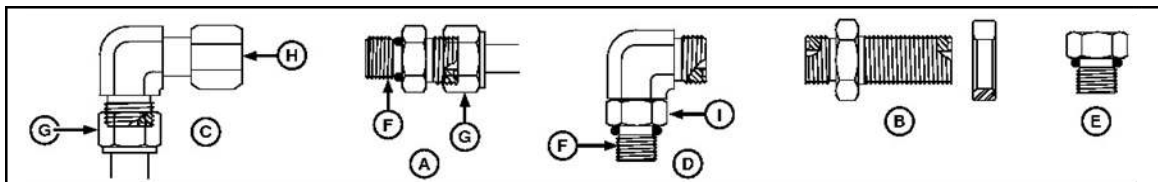

Figure 23: Common hydraulic fitting shapes and components

- | | |
|---|---------------|
| A. Stud Straight and Tube Nut | G. Tube Nut |
| B. Bulkhead Union and Bulkhead Lock Nut | H. Swivel Nut |
| C. 90° Swivel Elbow and Tube Nut | I. Lock Nut |
| D. 90° Adjustable Stud Elbow | |
| E. Port Plug | |
| F. Stud End | |



TIGHTENING HARDWARE

SAE Face Seal and O-Ring Stud End Fitting Torque Chart

SAE Face Seal and O-Ring Stud End Fitting Torque Chart - Standard Pressure-Below 27.6 MPA (4,000 PSI)																	
Nominal Tube OD Hose ID				O-Ring Face Seal/ Tube Swivel Nut				Bulkhead Jam Nut Torque			O-Ring Straight, Adjustable, and External Port Plug Stud Ends ⁶						
Metric Tube OD	Inch Tube OD			Thread Size	Swivel Nut Hex Size	Tube Nut Swivel Nut Torque		Jam Nut Hex Size	Jam Nut Torque		Thread Size	Straight Hex Size ⁷	Adj Lock Nut Hex Size	Steel or Gray Iron Torque		Aluminum or Brass Torque ⁸	
	mm	Dash Size	in.			mm	in.		N-m	lb.- ft				N- m	lb.- ft	in.	in.
5	-3	0.188	4.78	—	—	—	—	—	—	—	3/8-24	5/8	9/16	12	9	8	6
6	-4	0.250	6.35	9/16-18	11/16	16	12	13/16	32	24	7/16-20	5/8	5/8	16	12	11	8
8	-5	0.312	7.92	—	—	—	—	—	—	—	1/2-20	3/4	11/16	24	18	16	12
10	-6	0.375	9.53	11/16-16	13/16	24	18	1	42	31	9/16-18	3/4	3/4	37	27	25	18
12	-8	0.500	12.70	13/16-16	15/16	50	37	1-1/8	93	69	3/4-16	7/8	15/16	50	37	33	25
16	-10	0.625	15.88	1-14	1-1/8	69	51	1-5/16	118	87	7/8-14	1-1/16	1-1/16	69	51	46	34
20	-12	0.750	19.05	13/16-12	1-3/8	102	75	1-1/2	175	129	11/16-12	1-1/4	1-3/8	102	75	68	50
22	-14	0.875	22.23	13/16-12	—	102	75	—	175	129	13/16-12	1-3/8	1-1/2	122	90	81	60
25	-16	1.000	25.40	17/16-12	1-5/8	142	105	1-3/4	247	182	15/16-12	1-1/2	1-5/8	142	105	95	70
32	-20	1.25	31.75	1-11/16-12	1-7/8	190	140	2	328	242	1-5/8-12	1-3/4	1-7/8	190	140	127	93
38	-24	1.50	38.10	2-12	2-1/4	217	160	2-3/8	374	276	1-7/8-12	2-1/8	2-1/8	217	160	145	107
50.8	-32	2.000	50.80	—	—	—	—	—	—	—	2-1/2-12	2-3/4	2-3/4	311	229	207	153

⁶ Tolerance is +15%/-20% of mean tightening torque unless otherwise specified.

⁷ The straight hex wrench sizes listed apply to connectors only and may not be the same as the corresponding plug of the same thread size.

⁸ These torques were established using steel plated connectors in aluminum and brass.



Fast Ag Solutions
4130 Commerce Boulevard
Windom, MN 56101

1-800-772-9279 Toll Free

1-507-427-3861 Voice

1-507-427-3030 Fax

<https://fastagsolutions.com/>