



**973PT - 120' / 132'**  
**3PT SPRAYER**  
**OWNER'S MANUAL**





# Table of Contents

<b>Section</b>	<b>Page</b>
<b>Table of Contents</b> .....	<b>3</b>
<b>Warranty Registration</b> .....	<b>9</b>
<i>Warranty Inspection Report</i> .....	9
<b>Inspections</b> .....	<b>11</b>
<i>Pre-Delivery</i> .....	11
<i>Delivery</i> .....	12
<i>After-Sale</i> .....	13
<b>Serial Number Location</b> .....	<b>14</b>
<b>Owner Register</b> .....	<b>15</b>
<b>Foreword to the Owner</b> .....	<b>16</b>
<b>INTRODUCTION</b> .....	<b>18</b>
<i>Machine Components</i> .....	19
<i>Fence Row Nozzles</i> .....	20
<i>Boom Blue Lights</i> .....	20
<i>AutoYaw Control</i> .....	20
<i>Boom Auto-Height</i> .....	20
<b>SAFETY</b> .....	<b>21</b>
<i>Safety Alert Symbols and Signal Words</i> .....	21
<i>General Safety</i> .....	22
Prepare for Emergencies .....	22
Wear Protective Clothing .....	22
Protect Against Noise .....	22
Practice Safe Maintenance .....	22
Support Raised Equipment .....	23
Avoid Heating Near Pressurized Fluid Lines .....	23
Avoid High-Pressure Fluids .....	23
Inspect Lift Circuit Hoses .....	24
Store Attachments Safely .....	24
Electrical .....	24
Service Tires Safely .....	24
Dispose of Waste Properly .....	25
Handle Agricultural Chemicals Safely .....	25
Reduce risk of exposure and injury: .....	25



Handle Chemical Products Safely .....	26
Operate Hydraulics Safely .....	26
Use Safety Lights and Devices .....	27
Keep Riders Off Machine.....	27
Observe Maximum Transport Speed .....	27
EC Compliance Notification.....	28
Use a Signal Person .....	28
Tow Loads Safely .....	28
Avoid Overhead Power Lines .....	28
Prepare for Transport.....	29
Transport Safely .....	29
<i>Chemical Safety</i> .....	30
Personal Protection.....	30
Dilution.....	30
Storage.....	31
<i>Replace Safety Signs</i> .....	32
Wing.....	32
Main Frame.....	34
<i>Safety Features</i> .....	36
<i>Sign-Off Form</i> .....	37
<b>SPECIFICATIONS .....</b>	<b>38</b>
<i>Tractor Power, Size Recommendation</i> .....	38
<i>Hydraulic System Requirements</i> .....	38
<i>Machine Dimensions &amp; Specifications</i> .....	38
<b>PREPARING THE MACHINE .....</b>	<b>39</b>
<i>Use the Tractor Operator’s Manual</i> .....	39
<i>Break-In</i> .....	39
<i>Pre-Operation Checklist</i> .....	40
<b>CONTROLS .....</b>	<b>41</b>
<i>Spray Circuit Controller</i> .....	41
<i>Chemical Circuit Controls</i> .....	41
<i>Boom Function Control Box</i> .....	41
<b>CONTROLLER INSTALLATION .....</b>	<b>43</b>
<i>Spray Circuit Controller</i> .....	43
<i>Boom Function Control Box</i> .....	43
<b>ATTACHING and DETACHING .....</b>	<b>44</b>
<i>Attach the Machine Safely</i> .....	44
<i>Attach the Machine to the Tractor</i> .....	44



<i>Attach Warning Light Plug</i> .....	44
<i>Connect Rate Controller or Nutrient Applicator System Wiring</i> .....	45
<i>Make Proper Hose Connections</i> .....	45
<i>SCV Identification Chart</i> .....	46
<b>TRANSPORTING</b> .....	<b>47</b>
<i>Following Safe Transport Procedures</i> .....	47
<i>Preparing the Machine for Transport</i> .....	47
<i>Fold Boom for Transport</i> .....	47
<i>Transport Notes and Checks</i> .....	48
<i>Transporting the Machine</i> .....	48
<i>Using Warning Lights</i> .....	48
<i>Keep Riders Off the Machine</i> .....	48
<i>Caution for All Machines</i> .....	49
<i>Unfolding/Extending the Boom</i> .....	49
<b>HYDRAULIC FLOW</b> .....	<b>51</b>
<i>Regulating Hydraulic Flow to the Pump</i> .....	51
<i>Load Sensing Closed Center System (LS Closed)</i> .....	51
<i>Pressure Compensating Closed-Center System (PC Closed)</i> .....	51
<i>Open Center System (Open)</i> .....	52
<i>Tractor SCV Functions</i> .....	53
<b>SPRAYER CALIBRATION</b> .....	<b>54</b>
<i>Set Engine RPM</i> .....	54
<i>Controller Calibration</i> .....	54
<i>Nozzle Calibration</i> .....	54
<i>Machine Yard Calibration</i> .....	55
<i>Ground Speed Calibration</i> .....	55
<i>Area Coverage</i> .....	56
<i>Field Calibration</i> .....	56
<b>ADJUST GROUND SPEED</b> .....	<b>59</b>
<i>For broadcast spraying</i> .....	59
<i>For row crop spraying</i> .....	59
<b>PREPARING THE LIQUID SYSTEM</b> .....	<b>60</b>
<i>Clean Strainer Filter</i> .....	60
<b>FILLING THE TANK</b> .....	<b>61</b>
<i>Filling Fresh Water Rinse Tank</i> .....	61



<b>FIELD OPERATION .....</b>	<b>62</b>
<i>Operation Procedure .....</i>	<i>63</i>
<b>LUBRICATION &amp; MAINTENANCE.....</b>	<b>64</b>
<i>Lubricating and Maintaining the Machine Safely .....</i>	<i>64</i>
<i>Lubricant Storage .....</i>	<i>64</i>
<i>Grease .....</i>	<i>64</i>
Greases for Air Temperature Ranges.....	64
Alternative and Synthetic Lubricants .....	64
<i>Lubrication and Maintenance Intervals.....</i>	<i>65</i>
Each 10 hours or Daily.....	65
Each 50 Hours or Weekly .....	66
Before and After Each Season .....	66
As Required .....	66
<i>Cleaning.....</i>	<i>67</i>
Filters .....	67
Rinse Tank .....	68
<b>SERVICE .....</b>	<b>69</b>
<i>Practice Safe Maintenance.....</i>	<i>69</i>
<i>Work in a Clean Area.....</i>	<i>69</i>
<i>Service Machines Safely .....</i>	<i>69</i>
<i>Support the Machine Properly .....</i>	<i>70</i>
<i>Avoid High-Pressure Fluids .....</i>	<i>70</i>
<i>Preventing Hydraulic System Contamination .....</i>	<i>70</i>
<i>Replace Hydraulic Hoses .....</i>	<i>71</i>
<i>Tightening Hardware .....</i>	<i>71</i>
<i>Breakaway Tension.....</i>	<i>71</i>
<i>Aligning Booms .....</i>	<i>72</i>
<b>PREPARING FOR STORAGE .....</b>	<b>73</b>
<i>Removing from Storage.....</i>	<i>73</i>
<b>TROUBLESHOOTING.....</b>	<b>74</b>
<b>TIGHTENING HARDWARE .....</b>	<b>76</b>
<i>Metric Bolt and Screw Torque Values.....</i>	<i>76</i>
<i>Unified Inch Bolt and Screw Torque Values .....</i>	<i>77</i>
<i>Face Seal Fittings Assembly &amp; Installation - All Pressure Applications .....</i>	<i>78</i>
Face Seal O-Ring to Stud End Installation .....	78
Face Seal Adjustable Stud End O-Ring Installation.....	78
Face Seal Straight Stud End O-Ring Installation .....	78



---

Fitting Installation .....	78
Assembly Torque .....	78
<i>SAE Face Seal and O-Ring Stud End Fitting Torque Chart</i> .....	79





## Limited Warranty

Fast Ag Solutions warrants to the buyer that the new machinery is free from defects in material and workmanship.

This warranty is only effective as to any new machinery which has not been altered, changed, repaired or treated since its delivery to the buyer, other than by Fast Ag Solutions or its authorized dealers or employees, and does not apply to accessories, attachments, tools or parts, sold or operated with the new machinery, if they have not been manufactured by Fast Ag Solutions.

Fast Ag Solutions shall only be liable for defects in the materials or workmanship attributable to faulty material or bad workmanship that can be proved by the buyer, and specifically excludes liability for repairs arising as a result of normal wear and tear of the new machinery or in any other manner whatsoever, and without limiting the generality of the foregoing, excludes application or installation of parts not completed in accordance with this Operator's Manual, specifications, or printed instructions.

Written notice shall be given by registered mail, to the Manufacturer within seven (7) days after the defect shall have become apparent or the repairs shall have become necessary, addressed as follows:

Fast Ag Solutions  
4130 Commerce Boulevard  
Windom, MN 56101

This warranty shall expire one (1) year after the date of delivery of the new machinery.

If these conditions are fulfilled, Fast Ag Solutions shall at its own cost and at its own option either repair or replace any defective parts provided that the buyer shall be responsible for all expenses incurred as a result of repairs, labor, parts, transportation or any other work, unless Fast Ag Solutions has authorized such expenses in advance.

The warranty shall not extend to any repairs, changes, alterations, or replacements made to the new equipment other than by Fast Ag Solutions or its authorized dealers or employees.

This warranty extends only to the original owner of the new equipment.

Rubber parts (including tires, hoses, grommets) are not warranted.

This warranty is limited to the terms stated herein and is in lieu of any other warranties whether express or implied, and without limiting the generality of the foregoing, excluded all warranties, express or implied or conditions whether statutory or otherwise as to quality and fitness for any purpose of the new equipment. The Manufacturer disclaims all liability for incidental or consequential damages.

This 3PT Sprayer is subject to design changes and Fast Ag Solutions shall not be required to retrofit or exchange items on previously sold units except at its own option.

Warranty void if not registered.





# FAST 3PT SPRAYER

## Warranty Registration

This form must be filled out by the dealer and signed by both the dealer and the customer at the time of delivery.

Customer Name					
Address					
City		State		Zip	
Phone					

Dealer Name					
Address					
City		State		Zip	

Sprayer Model					
Serial Number					
Delivery Date					

## Warranty Inspection Report

### DEALER INSPECTION REPORT

- All Fasteners Tight
- Wheel Bolts Torqued
- Hydraulic Hoses and Fittings Free and Tight
- Fertilizer Hoses and Fittings Free and Tight
- Wheel Drive Turns Freely
- Lubricate Machine
- Check Tire Pressure
- Frame and Wings Level
- Monitors and Controllers Function
- Wiring Harness Connected

### SAFETY

- Safety Chain Installed
- All Guards Installed
- All Safety Signs Installed
- Reflectors, SMV, and Lights Clean
- Review Operating and
- Safety Instructions

I have thoroughly instructed the buyer on the above-described equipment which review included the Operator's Manual content, equipment care, adjustments, safe operation, and applicable warranty policy.

Date \_\_\_\_\_

Dealer's Rep. Signature \_\_\_\_\_

The above equipment and Operator's Manual have been received by me, and I have been thoroughly instructed as to care, adjustments, safe operation, and applicable warranty policy.

Date \_\_\_\_\_

Owner's Signature \_\_\_\_\_

White - FAST  
Yellow - Dealer  
Pink - Customer



**FAST 973PT Series Sprayer**

**SPRAYER SERIAL NUMBER** \_\_\_\_\_

**DATE PURCHASED** \_\_\_\_\_ / \_\_\_\_\_ / \_\_\_\_\_

**NOZZLE SPACING** \_\_\_\_\_

**PUMP MANUFACTURER:**

(CIRCLE ONE)

**ACE FMCSC-205F-HYD-304**

**ACE 255F-304 WET SEAL**

**ACE 255F-304 PWM WET SEAL**

**ACE FMC-750-HYD OASIS**

**ACE FMC-750 OASIS PWM**

**HYPRO 9306C-HM1C**

## Inspections

### Pre-Delivery

After the machine has been completely assembled, inspect it to be sure it is in good running order before delivering it to the customer. Ensure each item is found satisfactory or proper adjustment to the item(s) is made.

The following checklist is a reminder of points to inspect. It is neither an exclusive nor an exhaustive list of points to inspect. See the [Warranty Inspection Report](#) for a formal list.

- **SMV** emblem is installed, protective **shipping tape** is removed from reflectors, and **lights** are installed.
- All **grease fittings** are lubricated (see [LUBRICATION and MAINTENANCE](#) section in this Manual.)
- Inspect to be sure all **nuts** are tightened to proper torque and all **cotter pins** are spread.
- The **tires** are properly inflated (see [SPECIFICATIONS](#)).
- **Wheel bolts** are tightened to their specified torque(s).
- Fertilizer **row units** are properly adjusted.
- Warning **lights** are properly installed and operational.
- All customer-ordered **attachments** are installed or are available for delivery.
- Any parts scratched in shipment are touched up with **paint**.
- All **shipping decals** are removed.
- **Transport pins** are inserted in the transport holes.

This machine has been thoroughly checked and to the best of my knowledge is ready for delivery to the customer.

Signed: \_\_\_\_\_

Date: \_\_\_\_\_



## Delivery

The following checklist is a reminder of information which should be conveyed directly to the customer at the time the machine is delivered.

Check off each item as it is fully relayed to the customer.

- Tell the customer to use proper tools.
- Explain to the customer that the life expectancy of this or any other machine depends on regular lubrication as directed in Operator's Manual.
- Make the customer aware of all safety precautions that must be followed while using this machine.
- When the machine is transported on a road or highway at night or during the day, accessory lights and devices should be used for adequate warning to Operators of other vehicles. For this matter, tell the customer to check local governmental regulations.
- Give the Operator's Manual to the customer and explain all operating adjustments.

To the best of my knowledge, this machine has been delivered ready for field use, and the customer has been fully informed as to its proper care and operation.

Signed: \_\_\_\_\_

Date: \_\_\_\_\_

## After-Sale

The following is a suggested list of items to be checked at a dealer-customer mutually agreeable time during the first operating season.

- Check with the customer as to performance of machine. Make certain proper operating adjustments are understood.
- If possible, operate the machine to see that it is functioning properly.
- Acquaint the customer with any special attachment which will help do a better job.
- Go over the entire machine for loose or missing hardware.
- Check for broken or damaged parts.
- Ask the customer if recommended periodic lubrication has been performed.
- Review the Operator's Manual with the customer and stress the importance of proper lubrication and safety precautions.

Signed: \_\_\_\_\_

Date: \_\_\_\_\_

## Serial Number Location

Always give your dealer the Serial Number of your 3PT Sprayer when ordering parts or requesting service or other information.

The Serial Number is on a tag attached to the 3PT Carrier. Please mark the number in the spaces provided in this Manual for easy reference.





## Owner Register

<b>Model Number</b>	<b>Serial Number</b>
---------------------	----------------------

Name		
Address		
County	State	Date Purchased

Name		
Address		
County	State	Date Purchased

Name		
Address		
County	State	Date Purchased

Name		
Address		
County	State	Date Purchased

## Foreword to the Owner



Congratulations on your choice of an 3PT Sprayer to complement your agricultural operation!

READ THIS MANUAL carefully to learn how to operate and service your machine correctly. Failure to do so could result in personal injury or equipment damage. This Manual and safety signs on your machine may also be available in other languages.

THIS MANUAL SHOULD BE CONSIDERED a permanent part of your machine and should remain with the machine when you sell it.

MEASUREMENTS in this Manual are given in both metric and customary U.S. unit equivalents. Use only correct replacement parts and fasteners. Metric and inch fasteners may require a specific metric or inch wrench.

RIGHT-HAND AND LEFT-HAND sides are determined by facing in direction that the implement will travel when going forward.

WRITE SERIAL NUMBER of the machine in the [Specification](#) section and in the [Owner Register](#). Accurately record all numbers to help in tracing your machine should it be stolen. Your dealer also needs these numbers when you order parts. File identification numbers in a safe place off-machine.

BEFORE DELIVERING THIS MACHINE, your dealer performed a pre-delivery inspection.





THIS 3PT SPRAYER IS DESIGNED SOLELY for use in customary agricultural or similar operations for the purpose of applying chemical to row crops (“Intended Use”). Use in any other way is considered as contrary to the Intended Use. The manufacturer accepts no liability for damage or injury resulting from this misuse, and these risks must be borne solely by the user. Compliance with and strict adherence to the conditions of operation, service, and repair as specified by the manufacturer also constitute essential elements for the Intended Use.

THIS 3PT SPRAYER SHOULD BE OPERATED, serviced, and repaired only by persons familiar with all its particular characteristics and acquainted with the relevant safety rules (Accident Prevention). The Accident Prevention regulations, all other generally recognized regulations on safety and occupational medicine and the road traffic regulations must be observed at all times.

Any arbitrary modifications carried out on this 3PT Sprayer will relieve the manufacturer of all liability for any resulting damage or injury.

THIS DOCUMENT outlines the specific design and performance requirements for the use of a Fast Ag Solutions 3PT Sprayer assembly. The word “must” in this document indicates a mandatory requirement. The use of “should” indicates a recommendation of that which is advised but not required.

WARRANTY is provided as part of Fast Ag Solutions' support program for customers who operate and maintain their equipment as described in this Manual. The warranty is explained on the warranty certificate which you should have received from your dealer.

This warranty provides you with assurance that Fast Ag Solutions will back its products where defects appear within the warranty period. In some circumstances, Fast Ag Solutions also provides field improvements, often without charge to the customer, even if the product is out of warranty. Should equipment be abused or modified to change its performance beyond original factory specifications, the warranty will become void and field improvements may be denied.

TIRE MANUFACTURER'S warranty applicable to your machine may not apply outside U.S.

If you are not the original owner of this machine, it is in your interest to contact your local Fast Ag Solutions dealer to inform them of this unit's serial number. This will help Fast Ag Solutions notify you of any issues or product improvements.

## INTRODUCTION



Read this Manual carefully before operating your FAST equipment. The information presented will prepare you to safely operate and service your machine.

All Operators are required to read this Manual carefully and be acquainted with all the operating and adjustment procedures before attempting to operate. Failure to follow the information in this Manual and on decals may result in personal injury or equipment damage.

This Manual should be considered a permanent part of this equipment and should remain with the equipment when you sell it. Replacement manuals can be obtained from your Fast Ag Solutions dealer.

This equipment has been engineered and manufactured to provide dependable and satisfactory use. Like all mechanical products, it will require cleaning and upkeep. Inspect your equipment before putting it into service. Your authorized Fast Ag Solutions dealer has trained mechanics, genuine FAST service parts, and the necessary tools and equipment when service is needed. Use only genuine FAST parts for service or repairs. Substitute parts will void the warranty and may not meet standards for safe and satisfactory operation.

Warranty is provided as part of Fast Ag Solutions' support program for customers who operate and maintain their equipment as described in this Manual. The warranty is explained on the warranty certificate you should have received from your dealer. This warranty provides you with the assurance that Fast Ag Solutions will back its products where defects appear within the warranty period. Should the equipment be abused or modified to change its performance beyond the original factory specifications, the warranty will become void.

These instructions have been compiled from field experience and engineering data. Some information may be general in nature due to unknown and varying operating conditions. However, through experience and these instructions, you should be able to develop procedures suitable to your particular situation.

.....

The illustrations and data used in this Manual were current at the time of printing. However, due to possible in-line production changes, your machine may vary slightly in detail. We reserve the right to redesign and change the machines as necessary without notification.

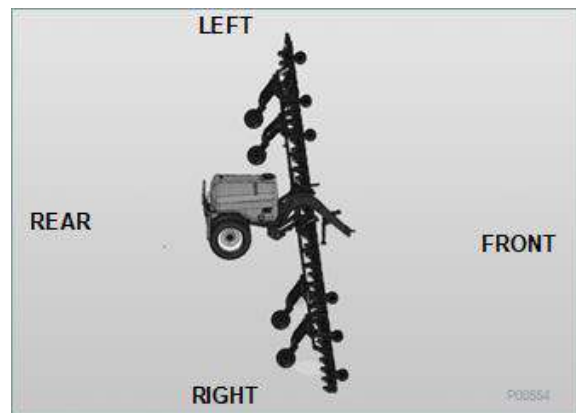

Figure 1: Orientation is viewed from behind the machine

## Machine Components

This 3PT boom sprayer is meant to distribute chemicals over a wide area. The system is pressurized by a hydraulic pump that provides flow for tank agitation, tank rinsing, and boom pressure.

A hand wash tank is mounted on the side of the carrier. An optional rinse tank is mounted near the center of the carrier.

A solenoid to each boom controls the flow to the wings, and a butterfly valve and flow sensor maintain the system pressure. Nozzles along the wings distribute the chemical solution over the field. A screen in the line next to the pump and after the solenoids removes contaminants from the system. The chemical system controller is mounted in the tractor cab for easy operation.

The booms attach to and are suspended from the back of the frame. The inner booms swing rearward at right angles to the frame for field operation. The outer booms pivot up and out for field operation. The wing breakaways swing back if they hit an obstruction.

An optional touchdown wheel kit is meant as a failsafe against changing boom height and headlands. **It is not intended to set the height of the boom.**

The boom position controller mounts in the cab for easy operation.

- A. Hand Wash Tank
- B. Inner Boom
- C. Outer Boom
- D. Breakaway Boom
- E. Boom Section Valves
- F. Boom Controller
- G. Chemical Controller (optional)
- H. Touchdown Wheel (optional)
- I. Auto-Height sensor (optional)

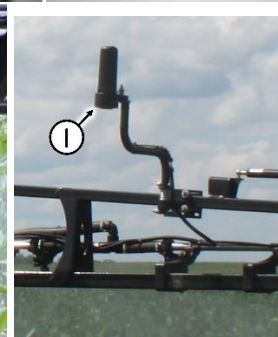
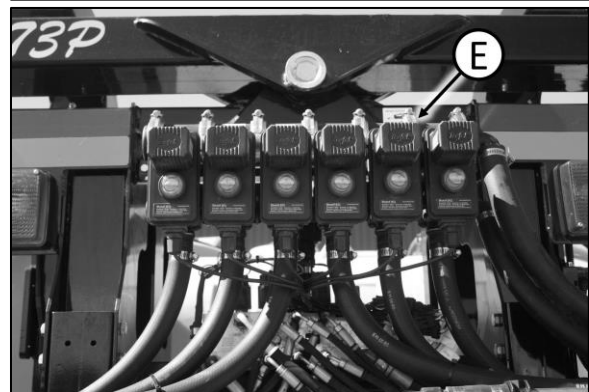
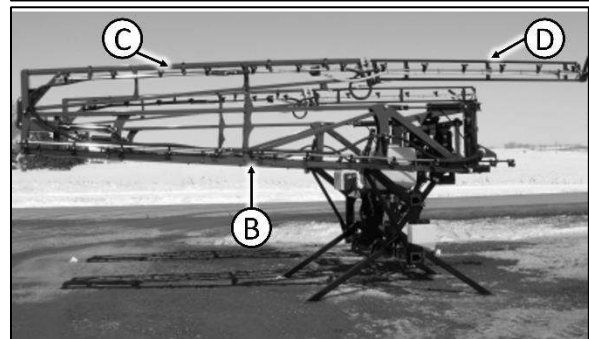
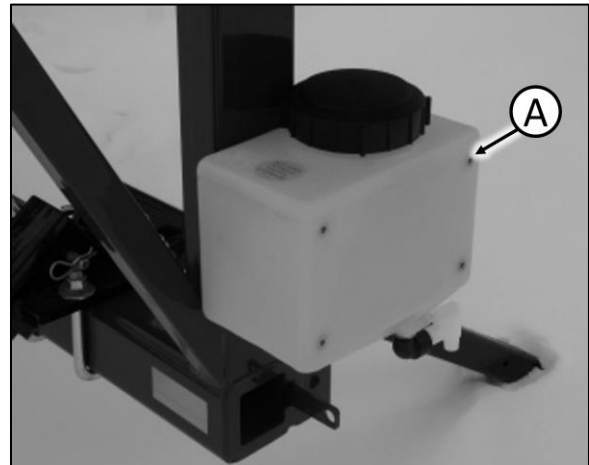

## Fence Row Nozzles

Fence Row Nozzles are equipped to provide coverage next to a fence or at the edge of a field. Open the inline valve when spraying next to a fence and turn it off when in the field.



Figure 2: Standard manual fence row nozzle



Figure 3: Electric shutoff fence row nozzle

## Boom Blue Lights

Blue lights are added to enhance the visibility of nozzle spray in low-light conditions. They are activated whenever the boom pivots out into field position.



Figure 4: Blue light on rectangular boom

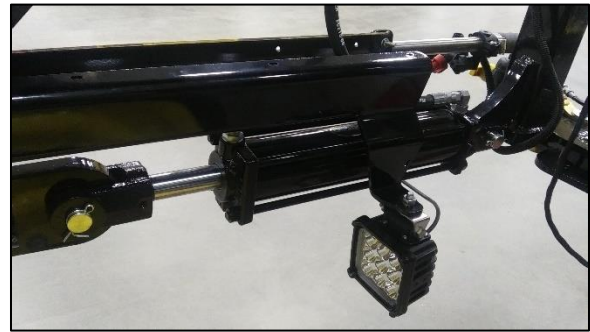
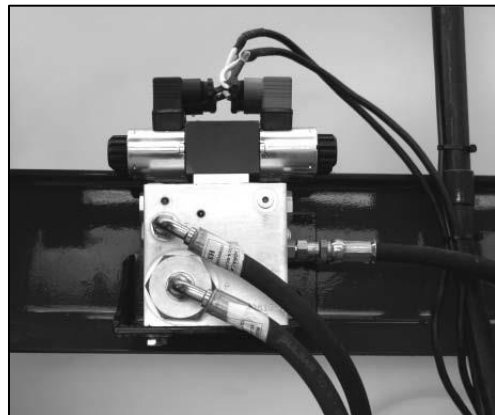

Figure 5: Blue light on truss boom

## AutoYaw Control

An ISO electronically controlled hydraulic boom relief system is designed to allow the boom wing fold cylinder to move as needed to dissipate accelerations of the boom wings.



## Boom Auto-Height

The sprayer can be equipped with an "Auto height" control system. The control valve is mounted on the back of the frame and connects into the hydraulic system to keep the booms at a preset height.

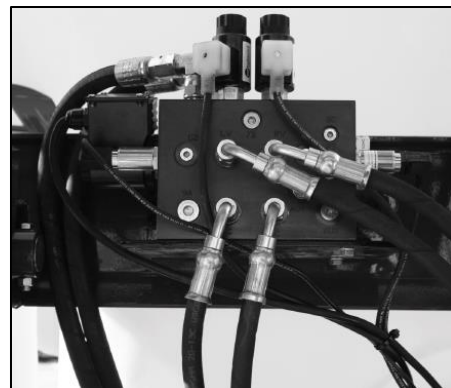



## SAFETY

The most important safety device on this equipment is a safe Operator. It is the Operator's responsibility to read and understand and follow all safety and operating instructions in this Manual.

As the Operator, you are responsible for the safe operation and maintenance of this equipment. You must ensure that you and anyone else who is going to operate, maintain or work around the machine is familiar with the operating and maintenance procedures and related safety information contained in this Manual.

You are the key to safety. Good safety practices protect you and the people around you. Be certain that everyone operating this equipment is familiar with the recommended operating and maintenance procedures and follows all safety precautions. Do not risk injury or death by ignoring good safety practices.

### Safety Alert Symbols and Signal Words



This is a Safety Alert Symbol. When you see this symbol on your machine or in this Manual, be alert to the potential for personal injury.

Follow recommended precautions and safe operating practices.

### Understand Signal Words

Throughout this Manual, the terms *CAUTION*, *WARNING*, and *DANGER* are used along with the Safety Alert Symbol to indicate the degree of personal safety hazard. The term *IMPORTANT* is used to indicate that failure to observe the hazard can cause damage to the equipment.



DANGER identifies the most serious hazards. DANGER or WARNING safety signs are located near specific hazards. General precautions are listed on CAUTION safety signs. CAUTION also calls attention to safety messages in this Manual.

### Follow Safety Instructions

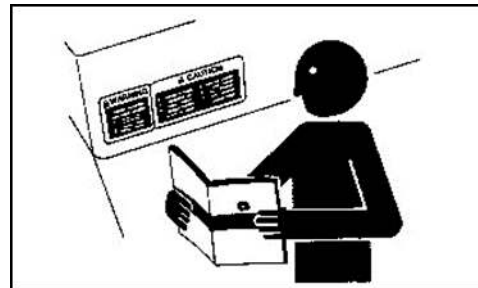

Carefully read all safety messages in this Manual and on your machine's safety signs. Keep safety signs in good condition.

Replace missing or damaged safety signs. Be sure new equipment components and repair parts include the current safety signs. Replacement safety signs are available from your Fast Ag Solutions dealer. There can be additional safety information contained on parts and components sourced from suppliers that is not reproduced in this Operator's Manual.

Learn how to operate the machine and how to use controls properly. Do not let anyone operate without instruction.

Keep your machine in proper working condition. Unauthorized modifications to the machine may impair the function and/or safety and affect machine life.

If you do not understand any part of this Manual and need assistance, contact your Fast Ag Solutions dealer.

## General Safety

### Prepare for Emergencies

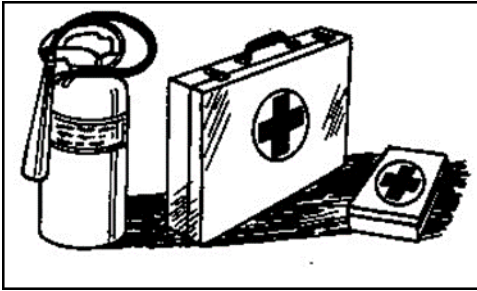

Be prepared if a fire starts.

Keep a first aid kit and fire extinguisher handy.

Keep emergency numbers for the poison control center, doctors, ambulance service, hospital, and fire department near your telephone.

In case of poisoning, get immediate medical attention.

### Wear Protective Clothing

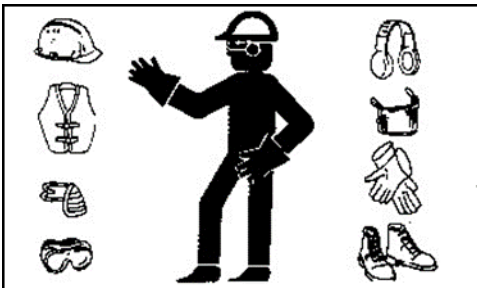

Wear close-fitting clothing and safety equipment appropriate to the job.

Operating equipment safely requires the full attention of the Operator. Do not wear radio or music headphones while operating the machine.

Keep hands, feet, hair, and clothing away from all moving and/or rotating parts.

### Protect Against Noise



Prolonged exposure to loud noise can cause impairment or loss of hearing.

Wear a suitable hearing protective device such as earmuffs or earplugs to protect against objectionable or uncomfortable loud noises.

### Practice Safe Maintenance



Understand service procedures before doing work. Keep the area clean and dry.

Never lubricate, service, or adjust the machine while it is moving. Keep hands, feet, and clothing away from power-driven parts. Disengage all power and operate controls to relieve pressure. Lower equipment to the ground. Stop the engine. Remove the key. Allow machine to cool. Securely support any

machine elements that must be raised for service work.

Keep all parts in good condition and properly installed. Fix any damage immediately. Replace worn or broken parts. Remove any buildup of grease, oil, or debris.

On self-propelled equipment, disconnect the battery ground cable (-) before making any adjustments on electrical systems or welding on the machine.

On towed implements, disconnect wiring harnesses from tractor before servicing electrical system components or welding on the machine.

### Support Raised Equipment



Always use a safety support when working on, under, or around the machine. Transport/Service locks can be used for this purpose.

Shut off the tractor's engine and remove the key when working on the machine.

If air has been allowed to enter hydraulic hoses or cylinders, bleed the hydraulic system before use. If there is a failure in the hydraulic system, unsupported or raised equipment could suddenly lower, causing serious personal injury or death.

If support is not available, completely lower wings and frame, relieve hydraulic pressure and disconnect hoses from tractor.

### Avoid Heating Near Pressurized Fluid Lines



Flammable spray can be generated by heating near pressurized fluid lines, resulting in severe burns to yourself and bystanders. Do not heat by welding, soldering, or using a torch near pressurized fluid lines or other flammable materials. Pressurized lines can accidentally burst when heat goes beyond the immediate flame area.

### Avoid High-Pressure Fluids



Inspect hydraulic hoses periodically – at least once per year – for leakage, kinking, cuts, cracks, abrasion, blisters, corrosion, exposed wire braid, or any other signs of wear or damage.

Replace worn or damaged hose assemblies immediately with Fast Ag Solutions approved replacement parts.

Escaping fluid under pressure can penetrate the skin causing serious injury.

Avoid the hazard by relieving pressure before disconnecting hydraulic or other lines. Tighten all connections before applying pressure.

Search for leaks with a piece of cardboard. Protect hands and body from high-pressure fluids.

If an accident occurs, see a doctor immediately. Any fluid injected into the skin must be surgically removed within a few hours or gangrene may result. Doctors unfamiliar with this type of injury should reference a knowledgeable medical source.

### Inspect Lift Circuit Hoses

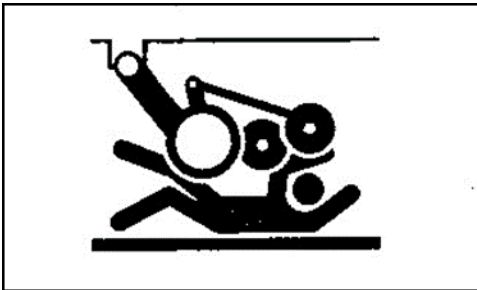

Avoid serious injury or death while working under a raised implement. Hydraulic hoses between the lift cylinders and hydraulic lock-up valves should be inspected frequently for leakage, kinking, cuts, cracks, abrasion, blisters, corrosion, exposed wire braid, or any other signs of wear or damage. Worn or damaged hose assemblies can fail during use and should be replaced immediately. See your Fast Ag Solutions dealer for replacement hoses.

### Store Attachments Safely

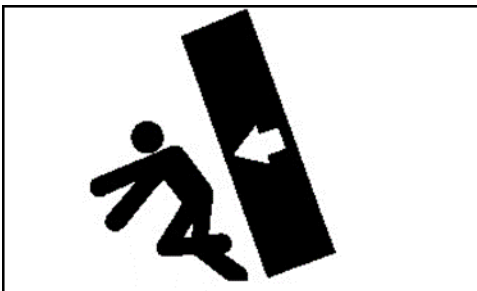

Stored attachments such as dual wheels can fall and cause serious injury or death. Securely store attachments and implements

to prevent falling. Keep playing children and bystanders away from storage area.

### Electrical



Check all electrical wiring and connections for damage. Keep the battery terminals clean and tight. Repair or replace any damaged part or wires that are loose or frayed.

### Service Tires Safely

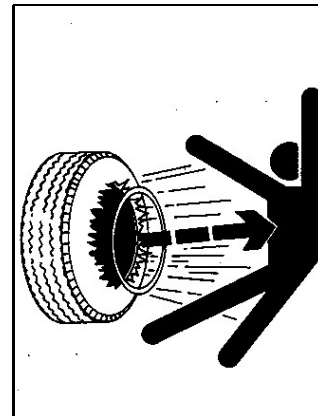

**CAUTION:** Explosive separation of a tire and rim parts can cause serious injury or death.

Do not attempt to mount a tire unless you have the proper equipment and experience to perform the job.

Never weld or heat a wheel and tire assembly. The heat can cause an increase in air pressure resulting in a tire explosion. Welding can structurally weaken or deform the wheel.

Always maintain the correct tire pressure. Do not inflate the tires above the recommended pressure. Never weld or heat a wheel and tire assembly. The heat can cause an increase in air pressure resulting in a tire explosion.



Welding can structurally weaken or deform the wheel.

When inflating tires, use a clip-on chuck and extension hose long enough to allow you to stand to one side and NOT in front of or over the tire assembly. Use a safety cage if available.

Check wheels for low pressure, cuts, bubbles, damaged rims, or missing lug bolts and nuts. Replace as necessary.

### Dispose of Waste Properly

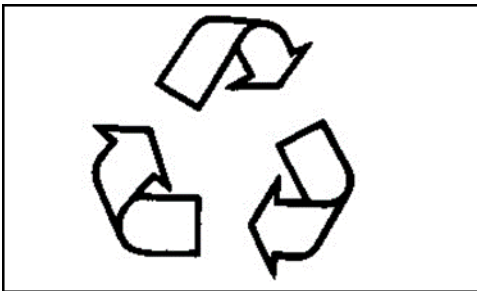

Improperly disposing of waste can threaten the environment and ecosystem. Potentially harmful waste used with equipment includes such items as oil, fuel, coolant, brake fluid, filters, and batteries.

Use leakproof containers when draining fluids. Do not use food or beverage containers that may mislead someone into drinking from them.

Do not pour waste onto the ground, down a drain, or into any water source.

Air conditioning refrigerants escaping into the air can damage the Earth's atmosphere. Government regulations may require a certified air conditioning service center to recover and recycle used air conditioning refrigerants.

### Handle Agricultural Chemicals Safely

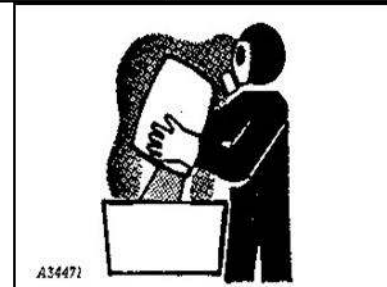
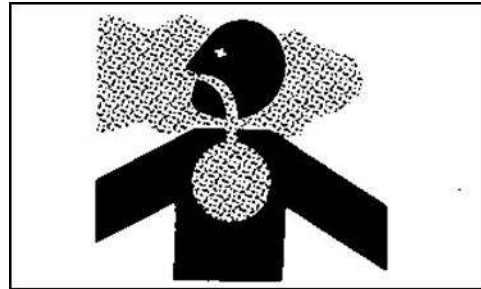

Chemicals used in agricultural applications such as fungicides, herbicides, insecticides, pesticides, rodenticides, and fertilizers can be harmful to your health or the environment if not used carefully.

Always follow all label directions for effective, safe, and legal use of agricultural chemicals.

#### Reduce risk of exposure and injury:

Wear appropriate personal protective equipment as recommended by the manufacturer. In the absence of manufacturer's instructions, follow these general guidelines:

*Chemicals labeled 'Danger'* (Most toxic) generally require use of goggles, respirator, gloves, and skin protection.

*Chemicals labeled 'Warning'* (Less toxic) generally require use of goggles, gloves, and skin protection.

*Chemicals labeled 'Caution'* (Least toxic) generally require the use of gloves and skin protection.

Avoid inhaling vapor, aerosol, or dust.

Always have soap, water, and a towel available when working with chemicals. If a chemical contacts skin, hands, or face, wash

immediately with soap and water. If chemical gets into eyes, flush immediately with water.

Wash hands and face after using chemicals and before eating, drinking, smoking, or urination.

Do not smoke or eat while applying chemicals.

After handling chemicals, always bathe or shower and change clothes. Wash clothing before wearing it again.

Seek medical attention immediately if illness occurs during or shortly after use of chemicals.

Keep chemicals in original containers. Do not transfer chemicals to unmarked containers or to containers used for food or drink.

Store chemicals in a secure, locked area away from human or livestock food. Keep children away.

Always dispose of containers properly. Triple rinse empty containers and puncture or crush containers and dispose of properly.

### Handle Chemical Products Safely



Direct exposure to hazardous chemicals can cause serious injury. Potentially hazardous chemicals used with FAST equipment include such items as lubricants, coolants, paints, and adhesives.

A Material Safety Data Sheet (M/SDS) provides specific details on chemical products: physical and health hazards, safety procedures, and emergency response techniques.

Check the M/SDS before you start any job using a hazardous chemical. That way you will know exactly what the risks are and how to do the job safely. Then follow the procedures with the recommended equipment.

### Operate Hydraulics Safely



Before operating, make sure air has been bled from wing-fold hydraulic system.

Be sure the area around the machine is clear before raising or lowering the machine's frame or wings.

Do not operate with wings folded.

Do not operate close to the edge of a ditch, creek, gully, or steep embankment. Avoid holes, ditches, and obstructions which may cause the tractor, machine, or towed equipment to roll over, especially on hillsides.

Avoid sharp turns on hillsides.

Slow down when turning, traveling over rough ground, or when turning on inclines.

Always shut off tractor and shift to PARK or set brakes when leaving tractor. Remove key when leaving tractor unattended.

Always have the tractor stop on level ground when raising or lowering wings. Operate the machine from tractor seat only. If chemicals are used, follow the manufacturer's recommendations for handling and storage.

Tow the machine behind a properly equipped tractor only.

## Use Safety Lights and Devices

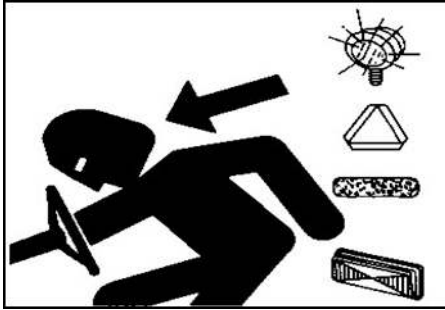

Prevent collisions between other road users, slow moving tractors with attachments or towed equipment, and self-propelled machines on public roads. Frequently check for traffic from the rear, especially in turns, and use turn signal lights.

Use headlights, flashing warning lights, and turn signals during both day and night. Follow local regulations for equipment lighting and marking. Keep lighting and marking visible, clean, and in good working order. Replace or repair lighting and marking that has been damaged or lost.

## Keep Riders Off Machine

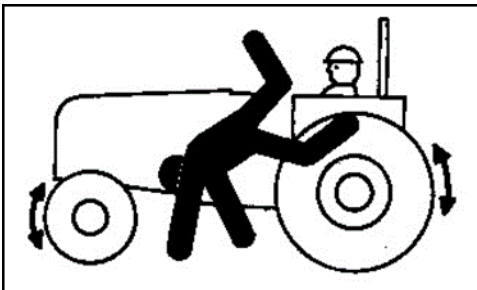

Only allow the Operator on the machine. Keep riders off.

Riders on the machine are subject to injury such as being struck by foreign objects and being thrown off of the machine. Riders also obstruct the Operator's view resulting in the machine being operated in an unsafe manner.

## Observe Maximum Transport Speed

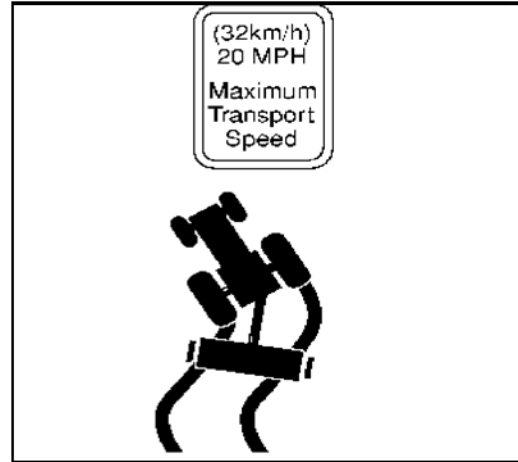

**⚠ CAUTION: Be sure all bystanders are clear of Sprayer.**

This implement is not equipped with service or parking brakes. The maximum transport speed for this implement is 20 MPH (32 KPH).

Some tractors are capable of operating at speeds that exceed the maximum transport speed of this implement. Regardless of the maximum speed capability of the tractor being used to tow this implement, do not exceed the implement's maximum transport speed.

Exceeding the implement's maximum transport speed can result in:

- Loss of control of the tractor/implement combination.
- Reduced or no ability to stop during braking.
- Implement tire failure.
- Damage to the implement structure or its components.

Use additional caution and reduce speed when towing under adverse surface conditions, when turning, and when on inclines. The minimum towing tractor weight for the 3PT Sprayer is 7650 lbs.

Never tow this implement with a motor vehicle. Tow only with a properly ballasted tractor.

## EC Compliance Notification

**MACHINE DOES NOT COMPLY WITH  
MACHINERY DIRECTIVE 2006/42/EC  
NOT FOR EUROPEAN MARKET**

- ⚠ WARNING:** Environmental transportation hazard. A loaded machine driven on public roads has a high risk of tire failure. Do not use the machine for transporting product(s) on public roads.

## Use a Signal Person

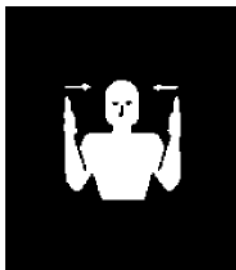

Use a signal person to direct movement of the tractor / implement combination, whenever the tractor operator's view is obstructed.

Designate one individual as THE signal person. Always have the signal person stand in clear view. Be sure the signal person stays a safe distance away from the machine when it is moving.

Prior to starting the tractor, discuss hand signals and what each signal means to avoid misunderstandings and confusion which could result in a serious injury or fatal accident for someone.

Keep all bystanders away whenever the machine is moved.

## Tow Loads Safely



Stopping distance increases with speed and weight of towed loads and on slopes. Towed loads with or without brakes that are too heavy for the tractor or are towed too fast can cause loss of control. Consider the total weight of the equipment and its load.

Observe these recommended maximum road speeds or local speed limits which may be lower:

If towed equipment does not have brakes, do not travel more than 32 km/h (20 mph) and do not tow loads more than 1.5 times the tractor weight.

Ensure the load does not exceed the recommended weight ratio. Add ballast to the recommended maximum for the tractor, lighten the load, or get a heavier towing unit. The tractor must be heavy and powerful enough with adequate braking power for the towed load. Use additional caution when towing loads under adverse surface conditions, when turning, and on inclines.

## Avoid Overhead Power Lines

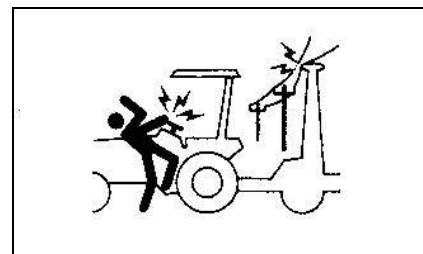

- ⚠ WARNING:** Keep away from overhead power lines. Serious injury or death may result.

Proceed cautiously under overhead power lines and around utility poles. Know the transport height of your machine. Electrocutation can occur without direct contact with overhead electrical lines.

### Prepare for Transport

**⚠ CAUTION: Avoid serious injury or death to your or others.**

Never tow the machine behind a truck or other motor vehicle. This machine is designed only to be towed with a properly sized and ballasted tractor.

Use a tractor large enough to maintain control. Properly ballast tractor for towing your machine. Refer to tractor Operator's Manual and this Manual to ensure that machine can be safely transported with your tractor.

Be aware of height and width restrictions to avoid a collision with overpasses or other road users.

Always fold wings fully. If wing fold cylinders are removed, chain wings together to prevent accidental lowering. Fully raise frame, close hydraulic lock-up valve (if equipped) and install Transport/Service locks before transporting. Latch the tractor brakes together.

Attach a properly sized safety chain for the load being towed. Refer to [Use a Safety Chain](#).

**⚠ IMPORTANT: Do not transport on a roadway unless the machine is equipped with proper functioning lights and reflective markings or emblems.**

Ensure that the lights and reflective markings or emblems are clean and visible. Contact your Fast Ag Solutions dealer for lights and lighting harnesses.

Always follow local and national regulations for equipment size, lighting and marking before driving on public roadways. You are responsible for understanding and complying with all requirements regarding roadway transport. Refer to [Use Safety Lights and Devices](#).

### Transport Safely

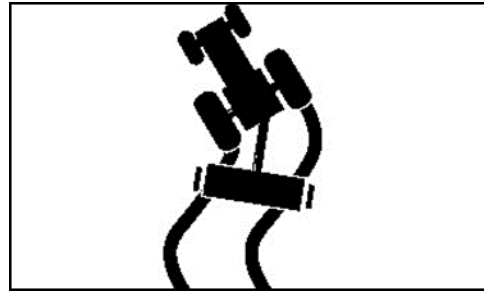

**⚠ CAUTION: When transporting, always travel at a reasonable and safe speed which permits adequate control of steering and stopping.**

Reduce speed considerably when traveling over rough ground. Be certain everyone is clear of the machine.

Do not exceed weight and speed guidelines. Refer to [Observe Maximum Transport Speed](#).

Towed loads can swerve and upset or cause loss of control. Refer to [Tow Loads Safely](#). Shift tractor into a lower gear when transporting down steep slopes or hills; never coast. Stop slowly.

Wide turns may be required with the machine in tow. Use caution in traffic and in congested areas.

To improve stability when traveling through the field, wings should be unfolded from transport position as soon as possible after leaving the roadway.

**⚠ IMPORTANT: When transporting the machine on a roadway, ALWAYS USE appropriate lamps and devices for**



**adequate warning to operators of other vehicles.**

Refer to [Use Safety Lights and Devices](#).

## Chemical Safety

### Personal Protection

To reduce or eliminate contact with chemicals, it is necessary to wear adequate protective clothing, respirators, boots, goggles, and gloves.

**Respirators** - Protection against inhalation (but no skin contact) is provided quite economically when using face mask respirators. Choose a mask that will fit your face and check with the manufacturer about the details of filters and chemical cartridges used in the respirator model. Note that full- and half-face masks cannot be worn securely by those with beards, whiskers, sideburns, and moustaches. Instructions on the operational life and performance of filters and cartridges generally accompany the products. However, when carrying out spray operations, it is wise to change the filters each day, and the cartridges should be replaced when chemical odor is noticed. Wash the face mask with warm water and soap before installing a new cartridge and filter. Do not store cartridges and filters in the chemical storage area as they can absorb the chemical even when not in use.

**Goggles** - When a full mask is not worn, the use of protective goggles is necessary and is recommended to protect the eyes from pesticide vapor, solids, and accidental splashes particularly. Safety supply companies offer a range of goggles. Many goggles are resistant to chemicals, some have specially treated lenses to reduce fogging, and others have anti-fogging ventilation. Prescription-type glasses are also available to which side shields can be attached.

**Gloves** - Non-absorbent gloves should be worn at all times when handling, mixing, and applying pesticides. Neoprene has been found to be superior to rubber in resisting the penetration of pesticides. Other factors to be considered in selecting suitable gloves include sense of touch, wet grip, and cut and abrasion resistance. Gloves should not have fabric wristbands or lining and should fit properly. Always wash the glove inside and out after use. Leather gloves are not suitable.

**Footwear** - Non-absorbent footwear should be worn when applying pesticides. It is suggested that the most suitable boot is one that is knee length, acid and solvent resistant, and ribbed to prevent slippage. Neoprene is considered superior to rubber. Leather boots are not suitable.

**Clothing** - For general protection, coveralls should be worn along with gloves and a hat to minimize the hazard of the skin absorbing pesticides. Clothing should be changed and washed regularly following spraying. You can now purchase disposable clothing that provides protection against exposure resulting from pesticide drift, splashing, or spills. These garments (overalls, shirts and pants, head cover, and aprons) are light weight and cooler than rubber articles. Protective equipment and clothing are available from safety supply companies. Never use leather garments (e.g., jackets, gloves, or shoes) during the handling or application of pesticides. Leather can absorb chemicals, and it is very difficult to decontaminate leather articles.

### Dilution

Pest control is dependent upon the application of minute amounts of a toxic substance. This process starts with the proper mixing of the toxic material with water. It is very important that the operator reads the mixing and dilution instructions on the chemical container before starting. Combine the chemical and water in the proportions

recommended on the container only. Improper mixing can damage the crops or not affect the pests.

## Storage

Only use the quantity of chemical product(s) required for the job.

Store chemicals only in their original containers under lock and key to prevent children or animals from touching them.

Be very careful to wear the proper protective gear such as rubber gloves and goggles to protect yourself. Thoroughly wash all protective gear with a good detergent after use to remove all chemicals.

Never allow chemicals or solutions to touch the skin. Some can be absorbed through the skin. Should such a contact occur, flush the affected area immediately with clear water. Wash the area thoroughly with detergent to remove any residue.

When spraying is done, the machine should always be rinsed. Follow this procedure:

1. Add 25 to 50 gallons of water to the main tank after the chemical solution has been spent or drained.
2. Run the pump, wash circuit, and agitator for 5 minutes to circulate and rinse the inside of the tank.
3. Spray the rinse thinly over the previously sprayed field.

When spraying is finished for the season or when switching chemicals, wash the sprayer thoroughly.

See [PREPARING FOR STORAGE](#).

**▲ WARNING: Do not dispose of chemicals in the farmyard or in drainage ditches.**

## Replace Safety Signs

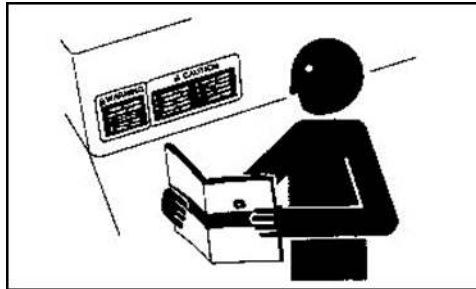

Replace missing or damaged safety signs. Use this Operator's Manual for correct safety sign placement.

There can be additional safety information contained on parts and components sourced from suppliers that is not reproduced in this Operator's Manual.

## Wing





# ! DANGER

To avoid injury or death stand clear of machine when wings are being folded or unfolded. Mechanical or hydraulic failure can allow wings to fall rapidly.





## Main Frame





**CAUTION**

1. Read and understand the Operator's Manual before using.
2. Read Chemical manufacturers' WARNINGS, Instructions and procedures before starting and follow them exactly.
3. Stop tractor engine, place all controls in neutral, set park brake, remove ignition key, and wait for all moving parts to stop before servicing, adjusting, repairing, unplugging or filling.
4. Always wear proper eye, breathing and clothing protection.
5. Stay away from chemicals, spray and drift. Keep others away.
6. Install and secure all guards before starting.
7. Keep hands, feet, hair and clothing away from moving parts.
8. Do not allow riders.
9. Keep all chemicals and hydraulic lines, fittings and couplers tight and free of leaks before starting and operating.
10. Stay away from overhead power lines.
11. Clear the area of bystanders before extending or folding wings.
12. Release second wing extend switch before first wing.
13. Hitch can upend. Do not stand over hitch when unhooking. Support hitch and sprayer on stands before removing pin.
14. Review Safety Instructions with all operators annually.

800002

**WARNING**

**HIGH PRESSURE FLUID HAZARD**

*To prevent serious injury or death from high pressure fluid:*

- Relieve pressure on system before repairing, adjusting or disconnecting.
- Wear proper hand and eye protection when searching for leaks. Use wood or cardboard instead of hands.
- Keep all components in good repair.

800004

**DANGER**

**CHEMICAL HAZARD**

*To prevent serious injury or death:*

<b>WEAR RUBBER GLOVES</b>	<b>DON'T BREATHE VAPOR</b>	<b>DON'T INGEST CHEMICAL</b>
<ul style="list-style-type: none"> <li>• Do not allow chemical or solution to touch skin. Some can be absorbed through the skin.</li> <li>• Wear rubber gloves and protective gear at all times.</li> </ul>	<ul style="list-style-type: none"> <li>• Stay away from chemical splash and vapor. Keep others away.</li> <li>• Do not breathe vapor.</li> <li>• Wear proper respirator when working with chemicals.</li> </ul>	<ul style="list-style-type: none"> <li>• Chemicals can be toxic.</li> <li>• If in eyes or mouth, read chemical manufacturers' instructions and follow them exactly.</li> <li>• Seek medical attention immediately.</li> <li>• A poison control number is normally inside the front cover of your telephone book.</li> </ul>

800007

**DANGER**

**ELECTROCUTION HAZARD**

**KEEP AWAY FROM POWER LINES**

*To prevent serious injury or death from electrocution:*

1. Stay well away from power lines when folding or extending wings. Electrocution can occur without direct contact.
2. Lower wings completely before moving or transporting.

800006

**WARNING**

**OVERHEAD HAZARD**

**KEEP AWAY**

## Safety Features



- A. SMV Emblem
  - i. Identifies slow-moving equipment and alerts traffic approaching from the rear.
- B. Reflectors
  - i. Alert other drivers to the machine's presence and width of slow-moving machinery on roadways.
- C. Warning Lights
  - i. Alert other drivers to the machine's presence and width of slow-moving machinery on roadways and signal turns.

In addition to the safety features shown here, other components, systems, safety signs on the machine, safety messages, and instructions in the Operator's Manual contribute to the safe operation of this machine when combined with the care and concern of a capable Operator.

The construction of this implement may not meet all local or national requirements for transport on a public roadway. In regions or countries that have national certification requirements for roadway transport, it may be impossible for this implement to be approved for such roadway transport. The customer is responsible for understanding and complying with all local, regional, and national requirements regarding roadway transport.



## SPECIFICATIONS

### Tractor Power, Size Recommendation

Use the machine with a tractor providing drawbar power in the following ranges:

Model	Tractor Power, kW (HP)	Quick Hitch Compatibility
973PT	75 (101)	Cat. 3 & 4N

### Hydraulic System Requirements

A tractor hydraulic system with ISO hydraulic couplers is required.

Tractor Selective Control Valves (SCV) at the listed flowrates and pressure are required for following:

Circuit	SCV Function	Flowrate	Pressure
1	Wing Fold Valve Block	11.4 LPM (3 GPM)	16203 kPa (162.0 bar) (2350 PSI)
2	Chemical/Fertilizer Pump Drive Motor	41.6 LPM (11 GPM)	13790 kPa (137.9 bar) (2000 PSI)

### Machine Dimensions & Specifications

Boom	60'	66'	120'	132'
Transport Height	3.9 m (12 ft. 11 in.)			
Transport Width	4.9 m (16 ft. 2 in.)			
Field Width	18.3 m (60 ft.)	20.1 m (66 ft.)	36.6 m (120 ft.)	40.2 m (132 ft.)
Section Count	6 or 10			
Nozzles	Triple Bodies			
Standard Hydraulic Pump	ACE FMCS-205F-HYD-304			
Controller Power	12 VDC, 15 A			
Cab Fold Box	12 VDC, 10 A			

Consult the factory for nozzle spacing options.

## PREPARING THE MACHINE

### Use the Tractor Operator's Manual

Always refer to tractor operator's manual for specific detailed information regarding operation of equipment.



### Break-In

See [TIGHTENING HARDWARE](#) for all torque values.

After **1/2 hour** of operation:

1. Tighten all critical fasteners and hardware to their required torque.
2. Check that no chemical or hydraulic lines are being pinched or crimped. Re-route as required.
3. Check that all nozzles are clean and working properly. Clean, adjust, or replace as required.
4. Check that all electrical connections are tight.
5. Lubricate all grease fittings.

After **5 hours** and **10 hours** of operation:

1. Tighten all fasteners and hardware to their required torque.
2. Check chemical and hydraulic line routings.
3. Check that all nozzles are clean and working properly.

After **50 hours** of operation:

1. Follow the normal servicing and maintenance schedule in [LUBRICATION & MAINTENANCE](#).

## Pre-Operation Checklist

Efficient and safe operation of the machine requires that each Operator reads and understands operating procedures and all related safety precautions outlined in this section. A pre-operational checklist is provided for the Operator. It is important for both personal safety and maintaining the good mechanical condition of the Sprayer that this checklist be followed.

Before operating the Sprayer, check the following items:

1. Lubricate machine per the schedule outlined in the [LUBRICATION and MAINTENANCE](#) section.
2. Use only a tractor of adequate power and weight to operate the Sprayer. See the [SPECIFICATIONS](#) section for recommendations.
3. Be sure that the machine is properly attached to the tractor. Be sure that a mechanical retainer is installed through the drawbar and that a pin and safety chain are installed.
4. Inspect all hydraulic lines, hoses, fittings, and couplers for tightness. See [Tightening Hardware](#) for break-in period recommendations.
5. Calibrate the Sprayer if at the start of the season or a new applicator rate is being used.
6. Check the condition and routing of all fluid hoses and lines. Be sure that all lines are routed in large arcs. Replace any that are damaged. Re-route those that are rubbed, pinched, or crimped. See [Replace Hydraulic Hoses](#).
7. Check chemical application components. Remove and replace any that are worn.
8. Remove all entangled material.
9. Clean the line filter(s) and mesh(es).
10. Replace any plugged nozzles or tubes.
11. Check that all electrical connections are made and tight.



## CONTROLS

### Spray Circuit Controller

A microprocessor-based controller is available to set, monitor, adjust, and display several spray circuit parameters for the operator. Review and follow the [calibration procedure](#) at the start of the season and when changing chemicals or nozzles. Familiarize yourself with each controller function and control before starting.



Figure 6: Optional Spray Circuit Controller

### Chemical Circuit Controls

The following monitoring components are installed in the liquid circuit when an automatic circuit controller system is selected.

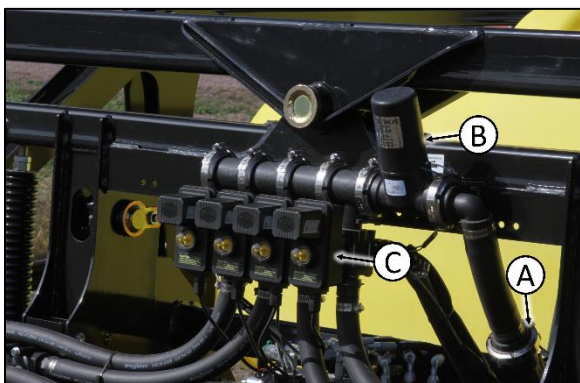

- A. Pressure meter
- B. Flowmeter
- C. Section (Boom) Valves

### Boom Function Control Box

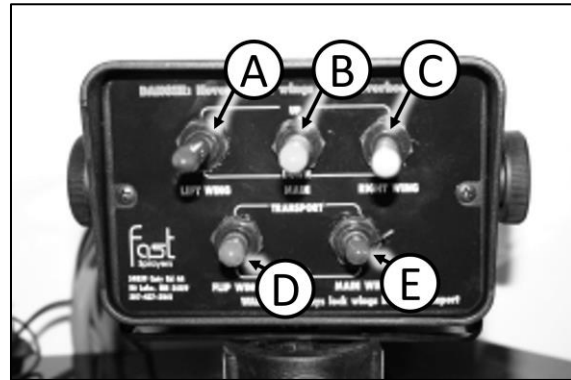

This control box is mounted in the cab and attached to a 12-volt power source. The wiring harness is routed across the hitch and plugs into the connector coming from the Sprayer. Be sure that there are no power lines next to the machine and that the machine is in an open area large enough to allow the booms to swing out without hitting any obstructions. The hydraulic circuit control lever to the boom function circuit must be placed in detent prior to operating.

- A. **Left Boom Tilt Position:** This spring-loaded-to-neutral-center toggle switch controls the left boom tilt function. Move the switch up and hold to raise the tip of the left boom and down to lower. Release the switch, the left boom will stop moving and remain in position. Use this function to raise the tip of the boom to clear obstructions.
- B. **Boom Up/Down:** This spring-loaded-to-neutral-center toggle switch controls the boom height cylinder. Move the switch up and hold to raise the entire boom assembly. Move the switch down and hold to move it down. Release the switch, the boom will stop and remain at that position.
- C. **Right Boom Tilt Position:** This spring-loaded-to-neutral-center toggle switch controls the right boom tilt function. Move the switch up and hold to raise the tip of the right boom

and down to lower. Release the switch, the right boom will stop moving and it will remain in position. Use this function to raise the tip of the boom to clear obstructions.

- D. **Main Wing Switch:** This spring-loaded-to-neutral-center toggle switch controls the field-to-transport function. Move the switch up and hold to pivot the outer boom to transport, and down to field position. Release the switch, the flip wing will stop and remain at that position.

**▲ IMPORTANT: Extend the cylinder completely when folding the outer boom to allow the boom to rotate until it hits the stop.**

- E. **Flip Wing Switch:** This spring-loaded-to-neutral-center toggle switch controls the flip wing fold function. Move the switch up and hold to fold the flip wing in and down to fold out. Release the switch, the flip wing will stop and remain at that position.

## CONTROLLER INSTALLATION

Each control box should be mounted in the tractor cab.

### Spray Circuit Controller



The control box is equipped with a "U" bracket secured by knobs on each end of the box. It provides a universal mounting system adaptable to any configuration.

Use the two holes provided in the bracket to mount the box to a solid surface. Position the box to face the operator and tighten the knobs to hold the box in position.

Cut the power cable to the required length. Connect the white wire to ground and the red wire to a 12-volt battery or power port. Refer to Controller's Manual. The panel fuse is an AGC-15 amp.

**▲ IMPORTANT: Do not connect across a 24-volt system. It will damage internal electrical components.**

Mount the box next to the sprayer controller to allow easy access. Connect to 12-volt power port. The box's fuse is an AGC-10 amp.

Plug the wiring harness from the trailer into the plug on the pigtail that comes from the Boom Function Control Box. Make sure to properly index the connector.

### Boom Function Control Box

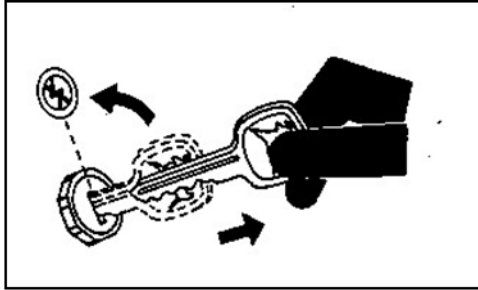

**ATTACHING and DETACHING****Attach the Machine Safely**

- ⚠ **CAUTION:** Prevent personal injury caused by unexpected movement of the machine. Engage the tractor's parking brake and/or place transmission in PARK, shut off the engine, and remove the ignition key before working around the hitch.

**Attach the Machine to the Tractor**

- ⚠ **CAUTION:** Make sure that all bystanders are clear of the working area.
1. Make sure there is enough room and clearance to safely back up to the machine.
  2. Slowly back the tractor until holes on the hitch and drawbar are aligned.
  3. Install drawbar pin and retainer.
  4. Attach safety chain (see [Attach Safety Chain to Tractor](#)) securely around tractor drawbar cage to prevent unexpected separation.
  5. Check that the Sprayer hydraulic system is compatible with the tractor's hydraulics: [Hydraulic System Requirements](#). Change the choice of the Sprayer model if required. Do not operate unless tractor and implement hydraulics are compatible.
  6. Connect Hydraulics



- ⚠ **WARNING:** Prevent serious injury or death. Relieve hydraulic system pressure before connecting hydraulic hoses.

- a. Use a clean rag or paper towel to clean dirt from couplers on hose ends and tractor couplers.
  - b. Relieve pressure in the hydraulic system.
  - c. Route hoses over the hitch and connect hoses to tractor couplers. Verify couplers are securely seated. See [SCV Identification Chart](#) for hose connections.
  - d. Be sure to provide slack for turning.
7. Route electrical lines over the hitch and connect to the tractor's electrical connectors.
  8. Detach with the same procedure in reverse.

**Attach Warning Light Plug**

- ⚠ **CAUTION:** When transporting the machine on a road or highway at night or during the day, use warning lights and devices for adequate warning to operators of other vehicles. For this matter, check local governmental regulations.

Various safety lights and devices are available from your Fast Ag Solutions dealer.

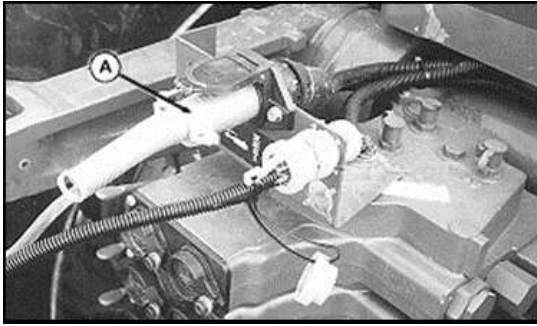

A. 7-Pin Connector Warning Light Plug

Attach a warning light plug (A) to the tractor's outlet socket.

Be sure warning lights, reflectors, and SMV emblem(s) are clean.

## Connect Rate Controller or Nutrient Applicator System Wiring

See manufacturer's Manuals for connecting controller cables to the tractor.

## Make Proper Hose Connections



**⚠ WARNING:** Escaping fluid under pressure can penetrate the skin and cause serious injury. Avoid the hazard by relieving pressure before disconnecting any hydraulic or other pressurized lines. Tighten all connections before applying pressure. Search for leaks with a piece of cardboard. Protect hands and body from high-pressure fluids.

If an accident occurs, see a doctor immediately. Any fluid injected in the skin

must be surgically removed within a few hours or gangrene may result. Doctors unfamiliar with this type of injury should reference a knowledgeable medical source. Such information is available from Deere & Company Medical Department in Moline, Illinois, U.S.A.

**⚠ IMPORTANT:** Hydraulic hoses can fail due to physical damage, kinks, age, and exposure. Check hoses regularly. Replace damaged hoses.

**⚠ IMPORTANT:** All hydraulic couplers must be clear of debris, dust, and sand. Use protective caps on fluid openings until ready to make connection. Foreign material can damage the hydraulic system.

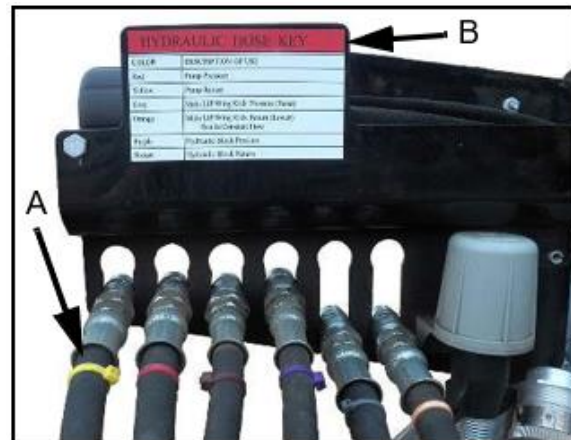

A. SCV Marker  
B. Hose Key Chart

Identify the SCV marker color (A) and then use the hose key chart (B) to connect to the correct SCV outlet. (See [SCV Identification Chart](#))

Make sure the quick couplers are fully engaged. If the quick couplers do not fully engage, check to see that the couplers are the same size and type.



## SCV Identification Chart

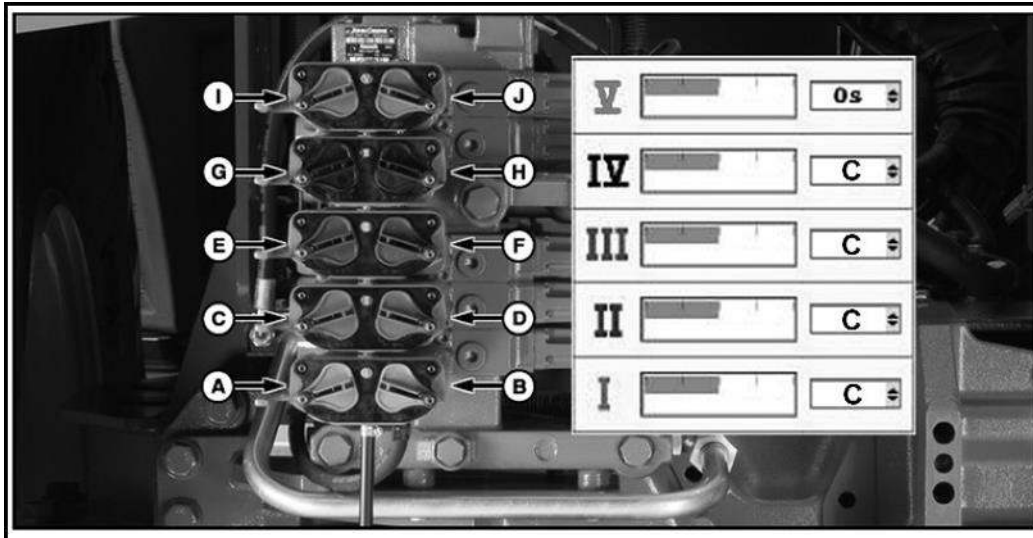

Legend	SCV ID	Tractor Flow Type	Hose Color	SCV Function
A	I	Return	Blue	Main Fold Return
B	I	Pressure	Green	Main Fold Pressure
C	II	Return	Yellow	Product Pump Return
D	II	Pressure	Red	Product Pump Pressure
E	III	Return	-	-
F	III	Pressure	-	-
G	IV	Return	-	-
H	IV	Pressure	-	-
I	V	Return	-	-
J	V	Pressure	-	-

**▲ IMPORTANT: Hose colors do not match SCV color**

See [Hydraulic System Requirements](#) for system compatibility.



## TRANSPORTING

### Following Safe Transport Procedures

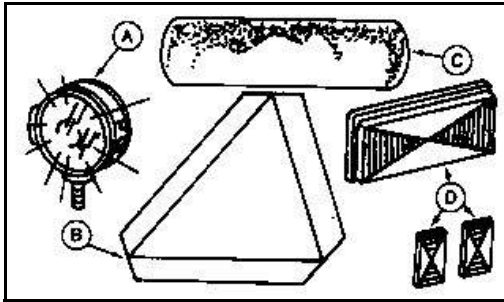

- A. Lights
- B. SMV Emblem
- C. Reflector Tape
- D. Reflectors

**⚠ CAUTION:** When transporting the machine on a road or highway at night or during the day, use warning lights and devices for adequate warning to operators of other vehicles.

Check local governmental regulations.

Various safety devices are available from your Fast Ag Solutions dealer. Keep safety items in good condition. Replace missing or damaged items.

Upward force on hitch may cause instability when transporting. Add BALLAST to tractor as required.

BEWARE of overhead wires and narrow gates. KNOW the transport height and width of your machine. (See [Machine Dimensions & Specifications](#).)

Travel at a reasonable and safe speed; REDUCE speed over rough or uneven terrain, slopes, and when turning. See [Observe Maximum Transport Speed](#).

BE SURE SMV emblem, reflectors, and warning lights are clean, visible, and in good condition.

## Preparing the Machine for Transport

### Fold Boom for Transport

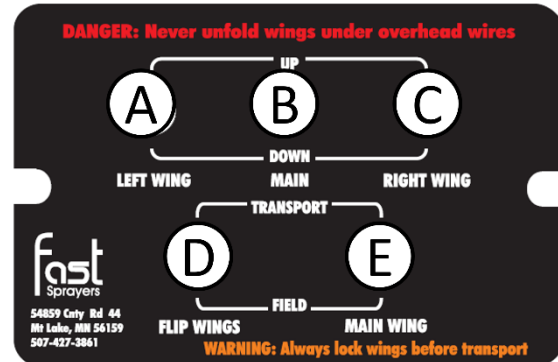

- A. Left Wing Tilt Switch
- B. Main Wing Height Switch
- C. Right Wing Tilt Switch
- D. Main Wing Fold Switch
- E. Flip Wings Fold Switch

1. Raise the center section with the Main Wing Height Switch (B) to its highest position.
2. Rotate the flip wings with the Flip Wings Fold Switch (E) to their transport position.
3. Tilt the main wings up with Tilt Switches (A) and (C).
4. Rotate the main wings with the Main Wing Fold Switch (D) to their backstops.
5. Lower the boom assembly with Main Wing Height Switch (B) into its transport supports.
6. Install the transport lock pins.
7. Close the boom lift cylinder line valve.
8. Boom is in transport position.



Figure 7: Boom cylinder valve



Figure 8: Transport lock pins (both sides)

- ⚠ **CAUTION:** Be sure all bystanders are clear of the Sprayer.
- ⚠ **CAUTION:** See [Observe Maximum Transport Speed](#) in the Safety section for towing information.

### Transport Notes and Checks

Be sure that the Sprayer is properly connected to the tractor. Always attach a safety chain between the Sprayer and the tractor and install a retainer through the drawbar pin.

Ensure that the hitch latch is fully engaged.

## Transporting the Machine

### Using Warning Lights

- ⚠ **CAUTION:** When transporting the machine on a road or highway at night or during the day, use accessory lights and devices for adequate warning to operators of other vehicles. Check local governmental regulations.

Various safety lights and devices are available from Fast Ag Solutions dealer. Keep safety items in good condition. Replace missing or damaged items.

During periods of limited visibility, use pilot vehicles and use extra lights on the machine.

During normal transport, both amber warning lights will flash in unison at high intensity and both red lamps will illuminate steadily at low intensity.

When a turn is signaled, red and amber tail lamps in the direction of turn will flash at high intensity and in unison. On the opposite side, amber and red lamps will illuminate steadily at high intensity.

### Keep Riders Off the Machine

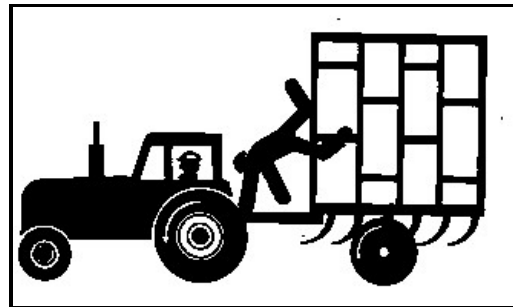

Riders are subject to injury such as being struck by foreign objects and being thrown off the machine. Riders obstruct the Operator's view resulting in the machine being operated in an unsafe manner.

## Caution for All Machines

**⚠ CAUTION:** When transporting the machine on a smooth surface road, do not exceed the maximum transport speed of 32 km/h (20 MPH). Reduce speed considerably when traveling over rough ground.



Reduce speed when turning. Do not uncouple tractor brake pedals and apply individually in an attempt to make a tighter turn.



Serious injury or death can result from contact with electric lines. Use care when moving or operating this machine near electric lines to avoid contact. Know transport height and width of machine. Check local regulations before transporting. (See [Machine Dimensions & Specifications](#) for transport height and width of machine.)

Transport with wings fully folded. Never raise or lower the center section or wings when moving. After folding, ALWAYS place the fold valve(s) in the neutral position for transport.

If wing-fold cylinders are removed or damaged, chain wings together to prevent injury or death caused by accidental falling of wings on you or others.

## Unfolding/Extending the Boom



**⚠ WARNING:** Prevent serious injury or death. The machine coming near or contacting power lines can cause electrocution. Electrocution can occur without contact. Fully lower wings before moving or transporting.

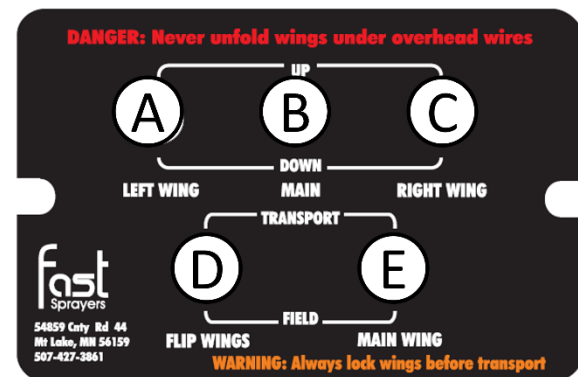

- A. Left Wing Tilt Switch
- B. Main Wing Height Switch
- C. Right Wing Tilt Switch
- D. Main Wing Fold Switch
- E. Flip Wings Fold Switch



Figure 9: Boom cylinder valve



Figure 10: Transport lock pins (both sides)

1. Place all controls in neutral, stop the engine, set the parking brake, and remove the ignition key before dismounting.
2. Retract the transport lock pins from their cradles.
3. Open the valve to the boom lift cylinder that allows it to lower.
4. Be sure that there is sufficient space to swing the booms into their field position.
5. Start the tractor and run at 1/3 throttle to provide oil for boom position/folding cylinders. See [Tractor SCV Functions](#).
6. Raise the booms to lift them out of their cradles with the Main Wing Height Switch (B).
7. Rotate the inner booms out with the Main Wing Fold Switch (D) until they are 90° to the frame. Watch for any interference.
8. Flip the outer booms out with the Flip Wings Fold Switch (E) into their fully extended position.
9. Lower the boom to spray height.
10. Boom is in field position.

## HYDRAULIC FLOW

### Regulating Hydraulic Flow to the Pump

Locate your tractor model and follow the appropriate setup instructions.

Always use the lowest flow setting that will achieve adequate results. Higher flows create heat in the hydraulic system.

**⚠ WARNING: FAILURE TO REGULATE OIL FLOW WILL CAUSE MOTOR FAILURE.**

**⚠ WARNING: NOT SUITABLE FOR PUMPING FLAMMABLE LIQUIDS.**

### Load Sensing Closed Center System (LS Closed)

Regulate oil flow with the tractor's FLOW CONTROL and FLOW LIMITER. (Do not use restrictor orifice.)



Figure 11: Flow Limiter



Figure 12: Flow Control

#### Setup Instructions:

1. (Optional) Remove adapter and install flow limiter in motor inlet port (marked I).
2. Close motor needle valve: loosen jam nut, screw needle valve clockwise until seated, and lock jam nut (factory setting.)
3. Shut off toolbar boom and agitation valves if equipped.

4. Adjust tractor flow control to minimum flow setting (Turtle).
5. Move hydraulic lever to "Lower/Retract" position to start pump.
6. Adjust tractor flow control until the toolbar shut-off (deadhead) pressure is within the pump's operating parameters. **Note:** If the flow limiter stops oil flow to the motor:
  - a. Move hydraulic lever to "Float" or "Neutral" to remove oil pressure from the flow limiter.
  - b. Adjust tractor flow control to a lower flow position.
7. Repeat steps 5 and 6.
8. Open the agitation valve(s).

### Pressure Compensating Closed-Center System (PC Closed)

Regulate oil flow by using a RESTRICTOR ORIFICE. (Do not use flow limiter.)

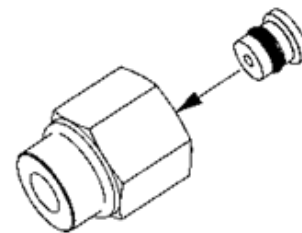

Figure 13: Restrictor Orifice

#### Setup Instructions:

1. Install restrictor orifice by inserting inside the adapter/restrictor body in the motor inlet port (marked I).
2. Close motor needle valve: loosen jam nut, screw needle valve clockwise until seated, and lock jam nut (factory setting.)
3. Set "Rabbit/Turtle" flow control to "Turtle".
4. Move hydraulic lever to the "Lower/Retract" position to start pump.



5. Adjust “Rabbit/Turtle” flow control and agitation valve(s) to get desired injection pressure.

### **Open Center System (Open)**

Select motor size closest to tractor’s hydraulic system capacity. Regulate oil flow with motor NEEDLE VALVE.

If using this system (not recommended), an open-center to folding-block conversion is advised. Consult the factory for PNs 630036/630037, 1 each.

(Do not use restrictor orifice or flow limiter.)

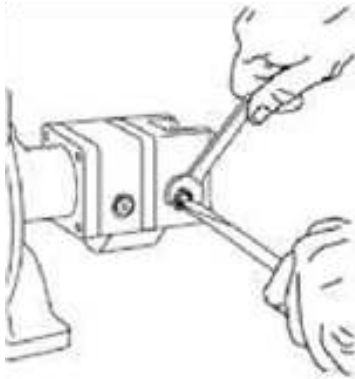

*Figure 14: Closing the Needle Valve*

#### Setup Instructions:

1. Shut off chemical/product supply and any tank agitation valves.
2. Loosen jam nut on motor and back out needle valve 3 or 4 turns counterclockwise.
3. Set tractor throttle to sprayer operating speed.
4. Move hydraulic lever to “Lower/Retract” position to start pump.
5. Screw needle valve clockwise until sprayer (deadhead) pressure is within the pump’s operating parameters and lock the jam nut.
6. Open the sprayer agitation valve to get desired injection pressure.



## Tractor SCV Functions

See [SCV Identification Chart](#) for connections.

**▲ NOTE:** The illustrations in this Manual are for explanatory purposes only. Your control system may differ in appearance and function.

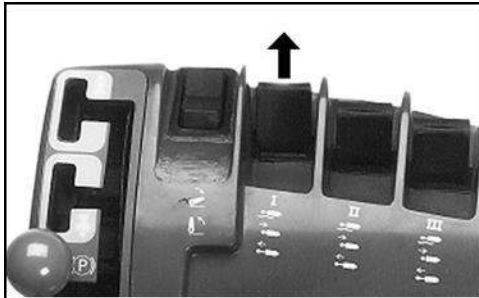

*Figure 15: SCV I Pushed Forward*

When the tractor's SCV I is pushed forward, the following functions are enabled:

1. Supplies hydraulic fluid flow to operate implement fold functions.

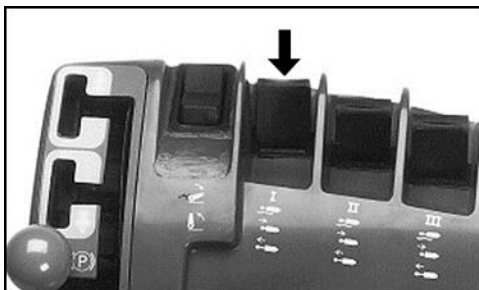

*Figure 16: SCV I Pulled Backward*

When the tractor's SCV I is pulled backward, the following functions are enabled:

1. Disables folding.

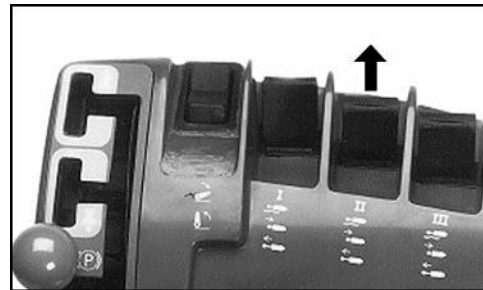

*Figure 17: SCV II Pushed Forward*

When the tractor's SCV II is pushed forward, the following functions are enabled:

1. Engages product pump for applying.

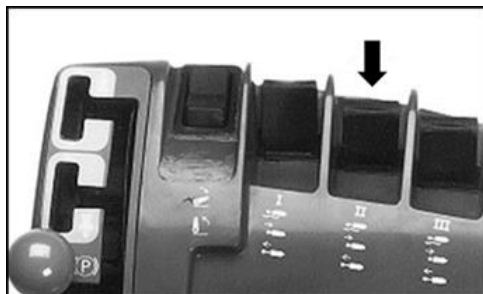

*Figure 18: SCV II Pulled Backward*

When the tractor's SCV II is pulled backward, the following functions are enabled:

1. Disengages product pump for transporting.

## SPRAYER CALIBRATION

A sprayer can only apply the proper amount of chemicals when each component in the system is functioning properly. Chemical action in the field is dependent upon the accurate application of minute amounts of the spray compound. A complete calibration of the machine is required at the start of each season or when changing chemicals during the spray season.

**It is the responsibility of the customer** to determine the amount of chemical that they want to apply for their particular application. Many factors affect how much chemical is applied such as: nozzle flow rate, chemical circuit pressure, pump speed, and ground speed, to name a few.

In this section, instructions are given on how to accurately determine flow- or application-rates and how to change them. It is recommended that this procedure be followed carefully so you know exactly how much chemical is being applied.

Work closely with your chemical supplier, nozzle manufacturer, and pest control specialists to equip and operate your machine to obtain the best results. Several nozzle types are available for the sprayer. Use the type appropriate for your application.

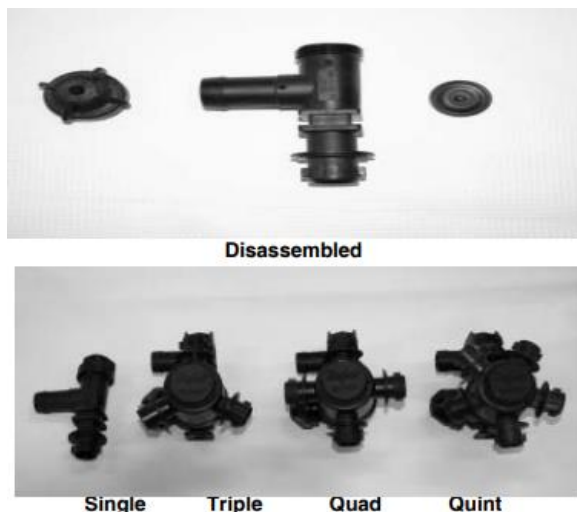

Figure 19: Nozzles typical for a dry boom



Figure 20: Wet boom triple and single assemblies

## Set Engine RPM

Although the exact value of the engine speed is not particularly important to sprayer function, it is recommended that it always be set at 2/3 or more throttle position. This will ensure that there will be sufficient oil flow through the hydraulic system and sufficient power to maintain the ground speed.

Select the desired engine RPM and always perform the calibration and run in the field at the same setting.

## Controller Calibration

The controller must be set and calibrated for your specific machine. Refer to the Controller's Manual and follow its Calibration procedure. Use the same controller settings during sprayer component calibrations as used in the field.

The automatic controller will adjust the chemical circuit to provide for a uniform application rate when ground speed changes up to + 20%. However, the system must be calibrated to determine the application rate at the nominal starting point.

## Nozzle Calibration

Consult your dealer or the factory to determine the type of nozzles on your machine and their specific nominal flow rate. To determine or set the application rate, the flow rate of solution through the nozzles must be known. Operate the tractor at the same RPM and hydraulic setting as if running in the field. Start with the chemical circuit pressure

at 20 PSI. Increase or decrease pressure as required to obtain the desired flow rate.

**⚠ CAUTION: Never calibrate nozzles with active chemical in the tank. The solution can contaminate people, the workplace, and the environment.**

**⚠ NOTE: If the Controller cannot produce the required pressure in the chemical circuit, decrease the agitation flow to reset the system and try again.**

**⚠ NOTE: Measuring the flow rate for each nozzle will ensure a consistent and uniform spray pattern across the entire machine.**

1. Remove all the nozzles from the Sprayer.
2. Use clean water to wash each nozzle and the check valve.
3. Reinstall the nozzles in the booms.
4. Add clean water until the tank is half full.
5. Place a calibration cup under all the nozzles on each boom. Calibration cups are available from most agricultural offices or weed supervisors.
6. Run the tractor at the RPM selected for field operation. Operate the chemical circuit pump at the desired pressure and measure the time that it takes to spray 1.0 quart (0.95 liters) through each nozzle. Use Table 4 to determine a per nozzle flow rate.
7. Replace all nozzles giving more than 110% the nominal flow rate.
8. Clean all nozzles components from nozzles less than 90% the nominal flow rate, and then recheck them.

## Machine Yard Calibration

After the nozzles have been calibrated, it is recommended that the entire system be calibrated. A yard run is the simplest method to determine the total volume delivered. To calibrate in the yard, follow this procedure:

1. Fill the tank full of water (no chemicals.)
2. Check that all screens are clean.
3. Set the chemical system and boom pressure to the desired value and run the tractor at the selected engine RPM.
4. Spray in a stationary position for a known period of time.
5. Refill the tank and accurately measure the amount of water used. This will give the amount of spray used per time.

The total volume can be changed by increasing or decreasing the chemical system pressure. However, if a change is made, it is recommended that the entire system be calibrated again to determine the new volumes.

## Ground Speed Calibration

For optimum spraying results, it is important to maintain a known, constant speed to spray the required chemical over a given area. Because of wheel slippage, the operator cannot rely on the tractor speedometer reading to give the value of true ground speed. The unit must be timed over a known distance to determine true ground speed.

To calibrate, follow this procedure:

1. Mark off a distance of 100, 200 or 300 feet (328m, 656m, 984m) in the field to be sprayed (longer distances provide greater accuracy).
2. Place the tractor in the proper gear for a speed as recommended in Table 1 and at the selected engine RPM. Always operate at the speed appropriate for the conditions.

*Table 1: Recommended application speeds*

Plant type	MPH	KPH
Cereal (Broadcast)	6 – 12	9.7 – 19
Row Crops	5 – 10	8.1 – 16
General	6 – 8	9.5 – 13

3. With the tank half-full of water, drive the tractor and sprayer through the measured distance.
4. Record the time required to travel the measured distance.
5. Determine the actual tractor speed from

Table 5. Recalibration is recommended per speed chosen.

**▲ IMPORTANT: Always operate at the engine RPM that will be used while spraying the field.**

If the machine is equipped with the automatic controller, the ground speed can be changed by up to 20% without making adjustments. However, do not decrease the throttle below its 2/3 setting.

## Area Coverage

To determine application rates, it is necessary to know the area covered by the sprayer per unit distance. Table 2 gives the area for seven widths.

*Table 2: Actual Sprayer coverage*

Sprayer Width	Acres		Hectares	
	1/2 mile	1/4 mile	1/2 km	1/4 km
60'	3.64	1.82	1.45	0.73
80'	4.85	2.42	1.94	0.97
88'	5.33	2.66	2.13	1.06
90'	5.45	2.73	2.18	1.09
100'	6.06	3.03	2.45	1.22
120'	7.28	3.64	2.90	1.45
132'	8.00	4.00	3.20	1.60

## Field Calibration

To verify application rates in the field, follow this procedure:

1. Fill the tank to the neck with water and mark the level of water.
2. Check that all screens are clean.
3. Set the chemical system pressure to the desired value and run the tractor at the selected engine RPM in the selected gear.
4. Drive through the measured distance while spraying.
5. Refill the tank to the same mark and measure the volume used.
6. Divide the amount of liquid sprayed by the area covered to determine the application rate.

$$\text{Appl. Rate} = \frac{\text{Volume sprayed}}{\text{Area covered}} = \frac{\text{gal. (L)}}{\text{acre (ha)}}$$

Table 3: Common conversions

1 km .....	0.62 mile
1 ha .....	2.5 acres
1 g .....	0.035 oz.
1 kg .....	2.2 lbs.
1 g/ha .....	0.014 oz/acre
1 kg/ha .....	0.88 lb/acre
1 ml .....	0.035 fl. oz.
1L .....	0.264 gal (US)
1L .....	0.22 gal (Imp.)
1L/s .....	15.85 gpm (US)
1L/s .....	13.20 gpm (Imp.)
1 kPa .....	0.145 psi
1 mm .....	0.04 in.
1 m .....	3.28 ft.
1 L/ha .....	0.106 gal (US)/acre
1 L/ha .....	0.088 gal (Imp.)/acre



# SPRAYER CALIBRATION

Table 4: Nozzle flow rates

U.S. Gallons		Imperial Gallons		Metric	
Time Time/qt min:sec	Flow Rate fl. oz./min	Time Time/qt min:sec	Flow Rate fl. oz./min	Time Time/liter min:sec	Flow Rate m Liter/min
6:24	5.0	8:00	5.0	7:00	143
6:40	4.8	8:20	4.8	7:18	137
6:57	4.6	8:42	4.6	7:38	131
		8:53	4.5	7:45	129
7:07	4.5			7:56	126
7:16	4.4	9:05	4.4		
7:37	4.2	9:31	4.2	8:20	120
				8:46	114
8:00	4.0	10:00	4.0		
8:25	3.8	10:32	3.8	9:10	109
8:53	3.6			9:43	103
		11:07	3.6		
9:09	3.5	11:26	3.5	10:00	100
9:25	3.4	11:46	3.4	10:19	97
				10:59	91
10:00	3.2	12:30	3.2		
10:40	3.0			11:38	86
		13:20	3.0		
11:26	2.8			12:30	80
		14:17	2.8		
12:18	2.6			13:31	74
12:48	2.5	15:23	2.6		
				14:05	71
13:20	2.4	16:00	2.5		
		16:40	2.4	15:30	69
14:32	2.2			15:52	63
		18:11	2.2		
16:00	2.0			16:33	57
		20:00	2.0		





# SPRAYER CALIBRATION

Table 5: Ground speed calibration

Speed mph	Time In Seconds To Travel			Time To Travel 1/2 mile minutes:seconds
	100 ft.	200 ft.	300 ft.	
5.0	13.6	27.3	40.9	6:00
5.4	12.6	25.3	37.8	5:33
5.6	12.2	24.4	36.5	5:21
5.8	11.8	23.5	35.3	5:10
6.0	11.4	22.7	34.1	5:00
6.2	11.0	22.0	33.0	4:50
6.4	10.7	21.3	32.0	4:41
6.6	10.3	20.7	31.0	4:33
6.8	10.0	20.1	30.1	4:23
7.0	9.7	19.5	29.2	4:17
7.2	9.5	18.9	28.4	4:10
7.4	9.2	18.4	27.6	4:03
7.6	9.0	17.9	26.9	3:57
7.8	8.8	17.5	26.3	3:52
8.0	8.5	17.0	25.6	3:45
8.2	8.3	16.6	24.9	3:40
8.4	8.1	16.2	24.4	3:34
8.6	7.9	15.8	23.7	3:29
8.8	7.7	15.5	23.2	3:25
9.0	7.6	15.2	22.7	3:20
9.2	7.4	14.8	22.2	3:16
9.4	7.3	14.5	21.8	3:11
9.6	7.1	14.2	21.3	3:08
10.0	6.8	13.6	20.5	3:00
Speed km/h	Time In Seconds To Travel			Time To Travel 1 kilometer minutes:seconds
	30.5 m	61.0 m	91.4 m	
7.0	15.9	31.7	47.6	8:44
7.5	14.8	29.5	43.2	8:08
8.0	13.6	27.3	40.9	7:30
8.5	12.9	25.9	38.7	7:05
9.0	12.2	24.4	36.5	6:41
9.5	11.6	23.2	34.7	6:21
10.0	11.0	22.0	33.0	6:02
10.5	10.5	21.0	31.5	5:46
11.0	10.0	20.1	30.1	5:29
11.5	9.6	19.2	29.2	5:21
12.0	9.1	18.2	27.3	5:00
12.5	8.7	17.5	26.3	4:49
13.0	8.4	16.8	25.3	4:38
13.5	8.1	16.2	24.4	4:27
14.0	7.8	15.7	23.5	4:19
14.5	7.6	15.2	22.7	4:10
15.0	7.3	14.7	22.0	4:02
15.5	7.1	14.0	21.3	3:55
16.0	6.9	13.8	20.7	3:47

### ADJUST GROUND SPEED

It will be necessary to establish a travel speed and then set the flow to give the desired application rate. Always run at the established travel speed.

However, the best results are obtained when the ground speed is 8 - 13 kph (5 - 8 mph). Ground speed variations in the field will automatically be compensated.

Always operate at a comfortable speed. Do not operate so quickly that the toolbar, trailer, or tank bounces while going through the field.

Effective results require that liquid be applied at a consistent depth in a consistent manner. Machine bouncing will prevent this required consistency.

### For broadcast spraying

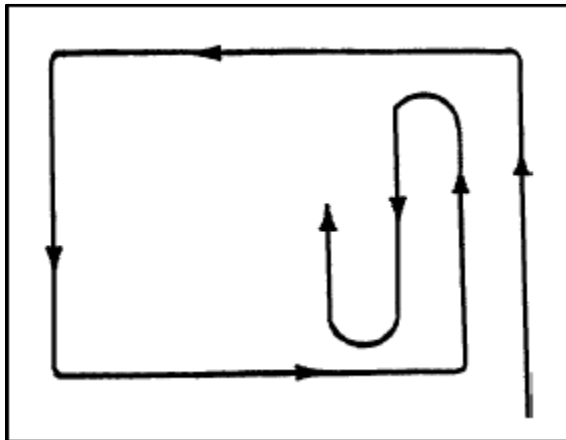

Figure 21: Broadcast travel pattern

It is recommended that the operator makes one pass around a field to start and then spray back and forth to obtain the best results. Using a marker system helps to prevent skips or overlaps.

If your field has headlands, be sure to allow sufficient space for turning.

### For row crop spraying

Start at one edge of the field and go back and forth until the field is completed.

Be sure the sprayer is calibrated, the nozzle height and pressure are known, and the tractor gear and RPM are determined before starting to spray (see [SPRAYER CALIBRATION.](#))

Proceed down the field at a constant speed. Use the selected gear, engine RPM and ground speed determined during the calibration of the machine application rate.

## PREPARING THE LIQUID SYSTEM

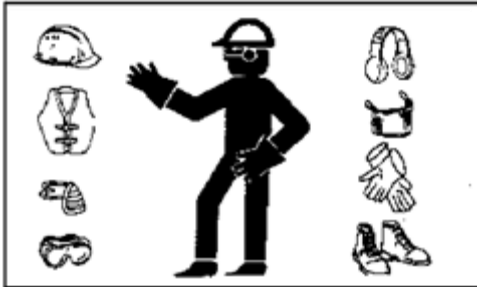

**⚠ CAUTION: Prevent serious injury or death**

Check the chemical or fertilizer M/SDS for proper handling instructions.

Toxic chemicals can enter the body by breathing spray or contact with bare skin.

Do not take a chance with your health and safety.

**▲ IMPORTANT: Do not run the pump dry - damage may occur.**

**▲ NOTE: Always turn the sump-valve off whenever working on liquid circuit components to isolate the liquid in the tank.**

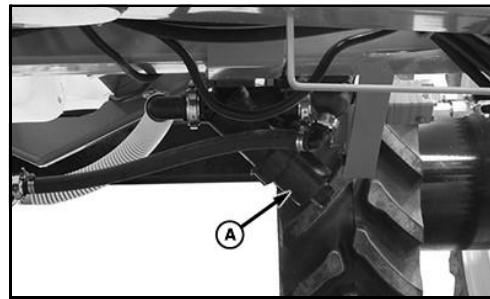

A - Screen

The liquid system is equipped with a screen (A) in its suction line to remove dirt and impurities.

### Clean Strainer Filter

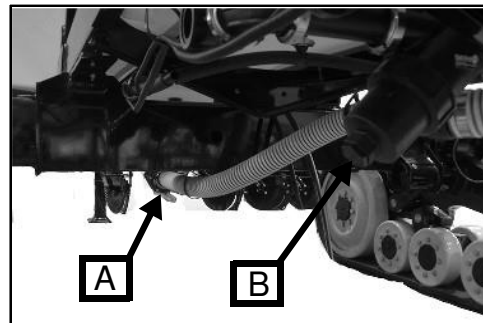

A. Sump Valve  
B. Cap

Clean the filter at the start of each day when the tank is empty or when dirt is detected in the system.

1. Clear area of bystanders.
2. Close sump valve (A) if there is liquid in the tank.
3. Relieve any pressure in the liquid circuit.
4. Remove cap (B) to access the screen.
5. Use clear water to clean the screen.

**▲ IMPORTANT: Do not over tighten the canister and crack its head.**

6. Install the screen in the canister and tighten by hand.
7. Open the sump valve if there is liquid in the tank.

**FILLING THE TANK**

**⚠ CAUTION: Prevent serious injury or death.**

Check chemical or fertilizer M/SDS for proper handling instructions.

Toxic chemicals can enter the body by breathing spray or contact with bare skin.

Do not take a chance with your health and safety.

**Filling Fresh Water Rinse Tank**

Fill the optional rinse tank with clean freshwater through its top lid whenever rinse water has been used. Do not allow this tank to run low on fresh water.

Use water from the rinse tank to clean, rinse or, wash anything that has become contaminated.

**⚠ WARNING: Do not drink the water from the rinse tank.**

The rinse tank water may become contaminated with sprayer chemicals or other contaminants.

## FIELD OPERATION

- ⚠ **WARNING:** Do not burn chemical containers as toxic fumes could contaminate the area.
- ⚠ **WARNING:** Do not discard chemical containers in ditches.
- ⚠ **WARNING:** Do not place containers in landfills. Dispose of them at the nearest container disposal site.
- ⚠ **DANGER:** Wear all appropriate PPE for handling chemicals.
- ⚠ **DANGER:** Do not breathe, touch, or ingest chemicals. Always wear protective clothing and follow safe handling procedures.
- ⚠ **CAUTION:** Read and understand the Operator's Manual and all safety signs before using.
- ⚠ **CAUTION:** Place all controls in neutral, stop tractor engine, turn monitor off, set park brake, remove ignition key, wait for nozzles to stop spraying before servicing, adjusting, repairing, or unplugging.
- ⚠ **CAUTION:** Before spraying a field, be familiar with all potential hazards: trees, rocks, ditches, gullies, etc. Plan the spraying route to avoid hazards. Remember you are driving a wide machine.
- ⚠ **USE CAUTION WHEN CORNERING.**
- ⚠ **CAUTION:** Keep hands, feet, hair, and clothing away from all moving and/or rotating parts.
- ⚠ **CAUTION:** Do not allow riders on the sprayer or tractor during operation or transporting.
- ⚠ **CAUTION:** Clear the area of all bystanders, especially children, before starting or filling the machine with water or chemical product(s).
- ⚠ **CAUTION:** Stay away from wing pinch points when folding or extending wings. Keep others away.
- ⚠ **CAUTION:** Stay away from power lines when extending or folding wings. Electrocutation can occur without direct contact.
- ⚠ **CAUTION:** Read the chemical manufacturers' warnings, instructions, and procedures before starting and follow them exactly.
- ⚠ **CAUTION:** Spray only when potential for chemical drift is at a minimum. Even small amounts can affect neighboring crops or sensitive plants and people.
- ⚠ **CAUTION:** Dispose of chemical containers by triple rinsing them into the sprayer tank or thoroughly rinsing, crushing, and delivering to regional disposal site.
- ⚠ **CAUTION:** In case of poisoning, get immediate medical attention.
- ⚠ **CAUTION:** Only rinse sprayer while still in the field. Spray the rinse thinly over the field already sprayed. Never contaminate the farmyard or drainage systems with sprayer rinse.
- ⚠ **CAUTION:** Do not eat in the field when spraying.
- ⚠ **CAUTION:** Before applying pressure to the hydraulic system, make sure all components are tight and that steel lines, hoses and couplings are in good condition.
- ⚠ **CAUTION:** Before applying pressure to the chemical system make sure that all connections are tight and that all hoses and fittings are in good condition.
- ⚠ **CAUTION:** Review safety instructions annually.

## Operation Procedure

Follow this procedure when using the sprayer:

1. Attach the Sprayer to the machine (see [ATTACHING](#) and [DETACHING](#).)
2. Review and follow the pre-operation checklist (see [Pre-Operation Checklist](#).)
3. Review the location and function of all controls (see [CONTROLS](#).)
4. Read and follow chemical manufacturers' instructions.
5. Calibrate the sprayer so you know exactly how much chemical is being applied (see [SPRAYER CALIBRATION](#).) The application of excess chemicals, even in small amounts, can have detrimental effects. Recalibration at the start of the season or when changing chemicals is a must.
6. Transport the sprayer to the working area (see [TRANSPORTING](#).)
7. Convert into field position (see [Unfolding/Extending the Boom](#).)
8. See [ADJUST GROUND SPEED](#).
9. Place the Master Boom switch in the OFF position and the appropriate Boom switches in the ON position.
10. Turn the booms ON with the Boom Master switch as the nozzles pass over the edge of the already sprayed headland and come to the area to be sprayed.
11. Use the individual boom switches as appropriate when finishing a field.
12. When completing a pass and approaching the sprayed headland, maintain the tractor RPM and ground speed until the nozzles have covered all the plants. This will ensure a consistent application rate at the ends of the field.

## Boom Tilt



Each side of the boom is equipped with a tilt cylinder that allows the operator to tilt the individual boom up at the ends of the field or whenever required to clear obstacles.

## Boom Breakaway



Each boom is designed with a break-away hinge between the outer booms and the boom extension (breakaway.) Each of these hinges will “break away” when the boom strikes an obstruction to prevent damaging the boom.



## LUBRICATION & MAINTENANCE

### Lubricating and Maintaining the Machine Safely

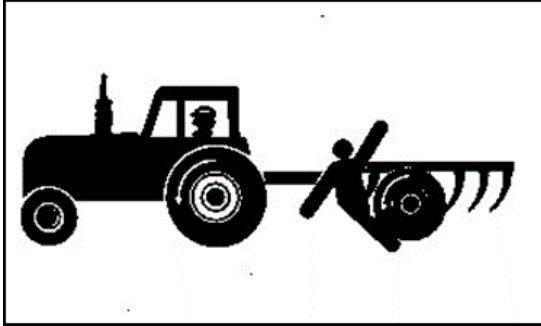

**⚠ CAUTION:** To help prevent serious injury or death to you or others caused by unexpected movement, be sure to service machine on a level surface.

If the machine is connected to a tractor, engage the tractor's parking brake, place the tractor's transmission in PARK, shut off the engine, and remove its key. If the machine is detached from the tractor, block wheels and use safety stands to prevent movement.

### Lubricant Storage

Equipment can operate at top efficiency only when clean lubricants are used.

Use clean containers to handle all lubricants.

Whenever possible, store lubricants and containers in an area protected from dust, moisture, and other contamination. Store containers on their side to avoid water and dirt accumulation.

Make certain all containers are properly marked to identify their contents.

Properly dispose of all old containers and any residual lubricant they may contain.

## Grease

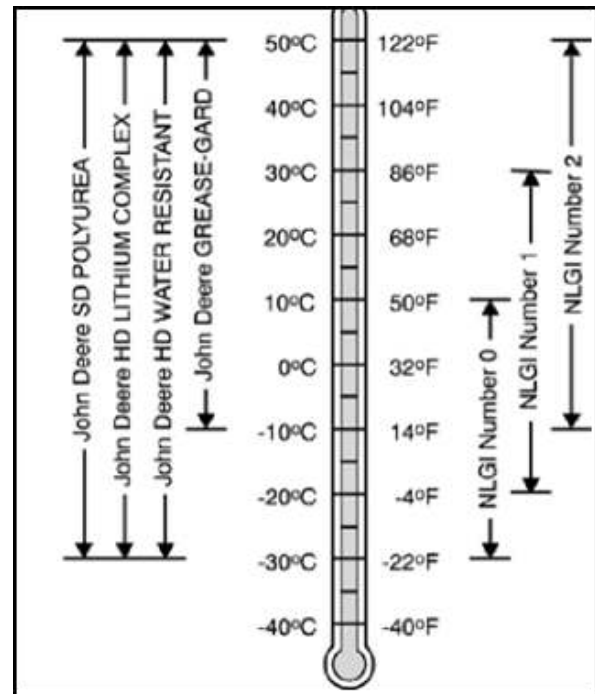

### Greases for Air Temperature Ranges

Use SAE multi-purpose high temperature grease with extreme pressure performance (EP) and is based on NLGI consistency numbers and the expected air temperature range during the service interval. An SAE multi-purpose lithium-based grease is also acceptable.

**⚠ IMPORTANT:** Some types of grease thickeners are not compatible with others. Consult your grease supplier before mixing different types of grease.

### Alternative and Synthetic Lubricants

Conditions in certain geographical areas may require lubricant recommendations different from those printed in this Manual. Synthetic lubricants may be used if they meet the performance requirements as shown in this Manual.

The temperature limits and service intervals shown in this Manual apply to both conventional and synthetic lubricants.

Re-refined base stock products may be used if the finished lubricant meets the performance requirements.

## Lubrication and Maintenance Intervals

Perform each lubrication and service illustrated in this section. Use a hand-held grease gun for all greasing.

Wipe the implements' grease fittings with a clean cloth before greasing to avoid injecting dirt or debris. Replace broken fittings immediately.

If a fitting will not accept grease, remove and clean it thoroughly or replace it. Clean the passageway.

### Each 10 hours or Daily

- Clean the Strainer
  - It is recommended that the fertilizer strainer screen be removed and washed with clean freshwater every 8 hours.

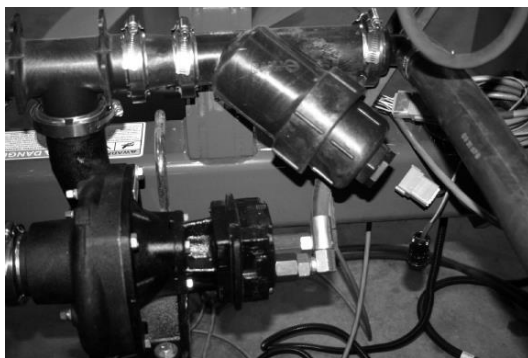

- Clean the boom feed line 50-mesh and pump filters (3 or more depending on options).



- Grease the center pivot pin (2 places)
- Grease the boom tilt pivots (1/boom)



- Grease the parallel linkages (4 links, 8 places total)

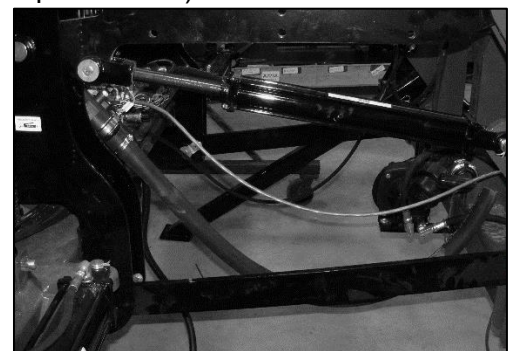

## Each 50 Hours or Weekly

- Grease the boom fold hinges' upper pivot (both sides)



- Grease the boom fold hinges' lower pivot (both sides)



- Grease the outer boom hinge (1/boom)

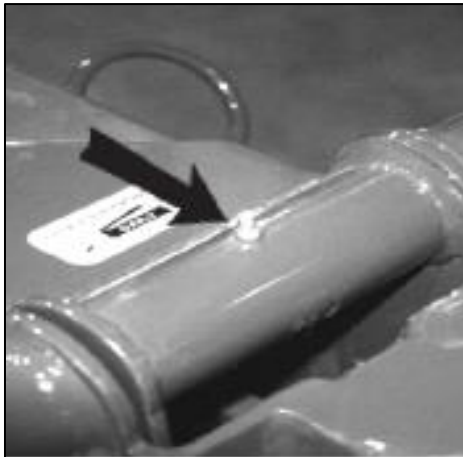

## Before and After Each Season

- -

## As Required

- Grease the breakaway pivot (4/boom)



## Cleaning

### Filters

The fluid in the Sprayer is continually being filtered through a screen filter in the boom control feed line, agitation, and boom feed lines. The Sprayer must have clean water to prevent clogging of the screens and inline check valves when in use.

At the start of each day before the water and chemicals are added, the screens should be checked. These screens must be cleaned daily or more often as required. To clean, follow this procedure:

1. If there is water or solution in the sprayer, close valves as needed to isolate the filters.
2. Loosen the filter bodies by hand. Do not use a wrench as this could damage the filter body.
3. Remove the screens and inspect them for dirt.
4. Clean them using clean water.
5. Inspect for holes or tears. If there is damage, replace it.
6. Install the screens and body to the filter heads and tighten by hand.

▲ **IMPORTANT: Do not use a wrench as this might damage the body. Do not over tighten and crack the head.**

7. Open the ball valves to allow the solution to circulate.
8. Drain all screens before storage to avoid freezing.



*Figure 22: Typical boom line filter/strainer*

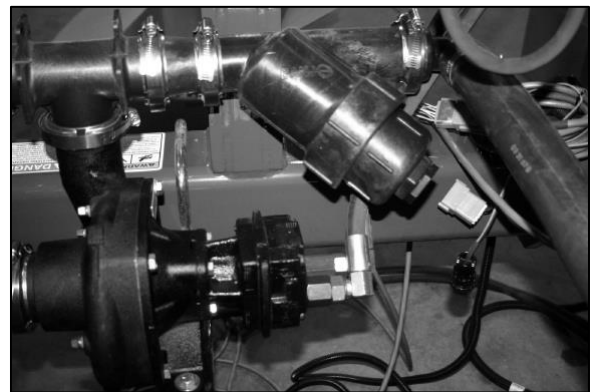

*Figure 23: Pump and boom line feed filter/strainer*



## Rinse Tank

**⚠ WARNING: Do not enter the tank at any time.**

## Daily

At the end of the working day, clean the system using this procedure:

1. After the chemical solution has been completely sprayed out through the booms, add 20 gallons (75 liters) clear water to the tank.
2. Run the agitation pump for 5 minutes.
3. Spray the rinse lightly over previously sprayed crop.
4. Repeat Steps 1 - 3 with 30 gallons of water.
5. Rinse the system again with clean water.
6. Clean the screen and nozzles.
7. Drain the tank and let it dry.

## To Change Chemicals or Remove Salt and Amines Formations

Perform this cleaning cycle when changing chemicals and/or annually.

1. Follow the procedure for daily cleaning.
2. Remove all screens and nozzles and wash them separately.
3. Add 50 gallons (200 liters) of clean water to the tank.
4. Add 1/2 gallon (2 liters) of household ammonia to the tank. (1-part ammonia to 100 parts water).
5. Run the agitation and rinse circuits for 5 minutes.
6. Spray half of the solution out of the booms.
7. Let the balance sit for a minimum of 8 hours; overnight is best.
8. Run the agitation pump for 10 minutes.
9. Spray solutions out of booms on the appropriate crop.

10. Rinse the system thoroughly with clean water and flush out the booms.
11. Drain the entire system and let it dry.

## To Remove Esters of 2, 4-D and MCPA Formations

Perform this cleaning cycle when changing chemicals or annually:

1. Complete the daily cleaning.
2. Remove the nozzles and screens and wash them separately.
3. Add 50 gallons (200 liters) of clean water to the- main tank.
4. Add dishwasher detergent to the tank (2 lbs. detergent to 50 gallons of water (1 kg:300 L)).
5. Run the agitation and rinse circuits for 10 minutes.
6. Spray the solution out of the booms on appropriate crops and drain thoroughly.
7. Add 50 gallons (200 L) of clean water to the tank.
8. Add 1/2 gallon (2 L) of household ammonia to the tank (1-part ammonia to 100 parts water).
9. Run the agitation pump for 10 minutes.
10. Spray half of the solution out of the booms.
11. Let the balance sit for a minimum of 8 hours; overnight is best.
12. Run the agitation and rinse circuits for 10 minutes.
13. Spray out of the booms on the appropriate crop.
14. Rinse the system thoroughly with clean water and flush out the booms.
15. Drain the entire system and let it dry.



**SERVICE****Practice Safe Maintenance**

Understand all service procedures before doing work. Keep the area clean and dry.

Never lubricate, service, or adjust the machine while it is moving. Keep hands, feet, and clothing away from power-driven parts. Disengage all power and operate controls to relieve pressure. Lower equipment to the ground. Stop the engine. Remove the key. Allow the machine to cool. Securely support any machine elements that must be raised for service work.

Keep all parts in good condition and properly installed. Fix any damage immediately. Replace worn or broken parts. Remove any buildup of grease, oil, or debris.

On self-propelled equipment, disconnect the battery ground cable (-) before making adjustments on any electrical systems or welding on the machine.

On towed implements, disconnect its wiring harnesses from the tractor before servicing any electrical system components or welding on the machine.

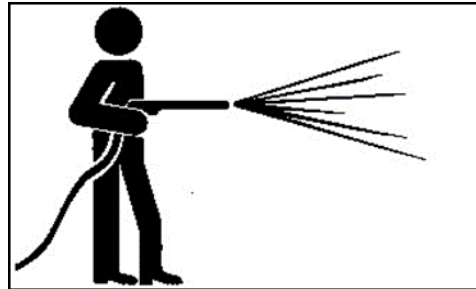
**Work in a Clean Area**

Before starting a job:

- Clean the work area and the machine.
- Make sure you have all the necessary tools to do your job.
- Have the right parts on-hand.
- Read all instructions thoroughly; do not attempt shortcuts.

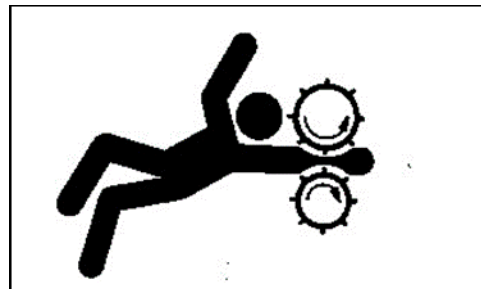
**Service Machines Safely**

Tie long hair behind your head. Do not wear a necktie, scarf, loose clothing, or necklace when you work near machine tools or moving parts. If these items were to get caught, severe injury could result.

Remove rings and other jewelry to prevent electrical shorts and entanglement in moving parts.



## Support the Machine Properly



Always lower the attachment or implement to the ground before you work on the machine. If the work requires that the machine or attachment be lifted, provide secure support for them. If left in a raised position, hydraulically supported devices can settle or leak down.

Do not support the machine on cinder blocks, hollow tiles, or props that may crumble under continuous load. Do not work under a machine that is supported solely by a jack. Follow the recommended procedures in this Manual.

When implements or attachments are used with a machine, always follow safety precautions listed in the implement or attachment's Operator's Manual.

## Avoid High-Pressure Fluids



Inspect hydraulic hoses periodically – at least once per year – for leakage, kinking, cuts, cracks, abrasion, blisters, corrosion, exposed wire braids, or any other signs of wear or damage.

Replace worn or damaged hose assemblies immediately with Fast Ag Solutions approved replacement parts.

Escaping fluid under pressure can penetrate the skin causing serious injury. Avoid the hazard by relieving pressure before disconnecting hydraulic or other lines. Tighten all connections before applying pressure.

Search for leaks with a piece of cardboard. Protect hands and body from high-pressure fluids.

If an accident occurs, see a doctor immediately. Any fluid injected into the skin must be surgically removed within a few hours or gangrene may result. Doctors unfamiliar with this type of injury should reference a knowledgeable medical source.

## Preventing Hydraulic System Contamination

**▲ IMPORTANT: Cleanliness is very important when working on a hydraulic system. Prevent contamination by assembling cylinders, hoses, couplers, and valves in a clean area of the shop.**

Leave protective caps on fluid openings until you are ready to make a connection. When charging the system, use a tractor or other source that contains clean oil free of abrasive materials.

Keep couplers clean. Abrasive particles, like sand or metal fragments, can damage seals, barrels, and pistons causing internal leakage.

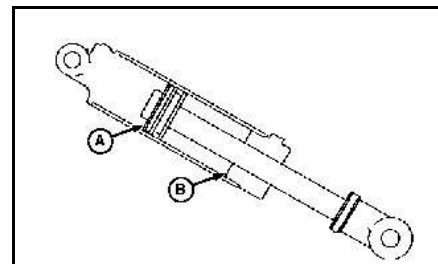

- A. Piston
- B. Rod Guide or Gland

- ▲ **IMPORTANT:** To help keep couplers clean, always place them in a storage position when they are not attached to the tractor.
- ▲ **IMPORTANT:** To prevent contaminants from entering the hydraulic system, filters must be installed at the tip of a supply hose. Additional filters are not recommended as they will restrict oil flow and adversely affect cylinder actuation time due to pressure drop.

Without a filter, large dirt particles can enter the cylinder and settle against the top side of piston (A) where they can cut the piston seal as the cylinder retracts.

## Replace Hydraulic Hoses

- ▲ **WARNING:** Avoid hazards due to escaping fluid under pressure. See [Avoid High-Pressure Fluids](#).

Hydraulic hoses between the lift cylinders and hydraulic lock-up valve should be inspected frequently for leakage, kinking, cuts, cracks, abrasion, blisters, corrosion, exposed wire braids, or any other signs of wear or damage.

Worn or damaged hose assemblies can fail during use and should be replaced immediately.

See your Fast Ag Solutions dealer for replacement hoses.

- ▲ **CAUTION:** If an incorrectly rated hose is used, machine damage, injury, or death could occur.

If hoses are to be fabricated, ensure that the hoses are rated at no less than 82,737 kPa (827 bar) (12,000 psi) burst pressure according to SAE Standard J517, 100R17 hose specification.

Incorrect hose length or routing can increase the chance of hose wear or damage. Use the

old hose as a guide for length and hose routing.

Incorrect fittings can damage mating parts or cause leaks. Make sure to use steel fittings approved for use by the hose's manufacturer. Use the correct size and thread.

Make sure hydraulic hoses and harnesses do not interfere with moving parts. Relocate hoses and harnesses and retain them with clamps.

## Tightening Hardware

Tighten all bolts to torques specified in [TIGHTENING HARDWARE](#) section unless otherwise noted.

Check tightness of hardware periodically.

## Breakaway Tension

Use the bolt to compress or relax the spring's clamping force on the breakaway's hinge as required.

The range of adjustment is 79.4mm – 88.9mm (3-1/8" – 3-1/2") from easy to hard pulling by one person on the end of the boom.



## Aligning Booms

The booms on each machine are designed with set screw adjustments that provide a method to adjust for straightness. By keeping the booms straight, the sprayer produces a consistent clearance to the crop.

1. Place the machine in its field configuration with the boom at a comfortable working height.
2. Place all controls in neutral, stop the engine, set the parking brake, remove the ignition key, and wait for all moving parts to stop before continuing.
3. Loosen the position bolt jam nut(s) at the hinge.
4. Turn the position bolt(s) to the required position.
5. Sight along the boom to be sure it is straight (level) at each hinge.
6. Tighten the fasteners.
7. Repeat as necessary.



*Figure 24: Inner boom*



*Figure 25: Outer boom*

**PREPARING FOR STORAGE**

**⚠ CAUTION: Store the unit in an area away from human activity. Do not permit children to play on or around the stored Sprayer.**

At the end of the season, thoroughly inspect and prepare the Sprayer for storage. Repair or replace any worn or damaged components to prevent any unnecessary downtime at the beginning of next season.

1. Empty any remaining liquid from tank. Flush the entire system with clean freshwater.
2. Open all liquid line connections, the end cap screen canister, and pump. Drain all fluids out of the system.
3. Add approximately 38 L (10 Gal.) of RV antifreeze per 3 m (10 ft.) of boom to the Rinse Tank.
4. Flush the system, then pump through screens, valves, nozzles, check valves, and orifices/tips.
5. Remove the nozzles from the boom and store them in a non-freezing location.
6. Thoroughly wash the machine using a pressure washer to remove all dirt, mud, debris, and residue to protect against corrosion.
7. Lubricate all grease points. Make sure all grease cavities have been filled with grease to remove any water residue from washing.
8. Inspect all hydraulic hoses, couplers, and fittings. Tighten any loose fittings. Replace any hose that is damaged or is separating from the crimped end of a fitting.
9. Inspect all liquid lines and connections. Tighten any loose fittings. Replace any line that is cut, nicked, or abraded.
10. Touch up all paint nicks and scratches to prevent rusting.
11. Fold inner and outer wings to the transport configuration.

12. Install the machine's storage stands.
13. Move the machine to a storage position.
14. Select an area that is dry, level, and free of debris.
15. Place planks under the stands for added support if required.
16. Unhook Sprayer from tractor.

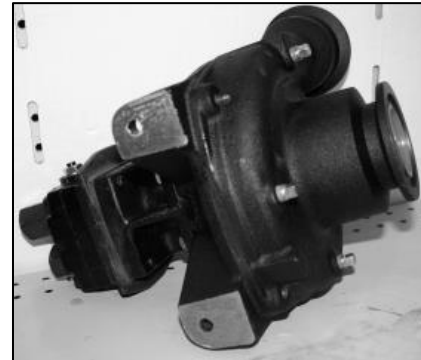

*Figure 26: Pump drain*

**Removing from Storage**

1. Clear the area of bystanders, especially small children, and remove foreign objects from the machine and working area.
2. Attach the tractor to the Sprayer.
3. Remove the machine's stands.
4. Check:
  - a. Attach and secure all liquid lines.
  - b. Screens and Nozzles.
  - c. All hardware. Tighten as required.
  - d. Tire pressure.
  - e. All hydraulic lines, fittings, and connections. Tighten as required.
5. Lubricate all grease fittings.
6. Replace any defective parts.
7. Add a small amount of liquid to the tank. Turn the product pump on momentarily and check that liquid comes out of each nozzle/injector.
8. Follow the [Pre-Operation Checklist](#) before using.

## TROUBLESHOOTING

Problem	Cause	Solution
System loses pressure.	Filter screen plugged	Clean chemical line screens
	Pump worn	Check and repair or replace pump
	Faulty suction hose	Check for collapsed suction hose. Replace hose
	Faulty regulator	Replace regulator
	Hose leaking	Tighten hose or replace hose
Sprayer pressure too high.	Return hose plugged	Clean or replace hose
	Faulty pressure sensor	Calibrate sensor. Replace as required
	Faulty regulator	Repair or replace valve
	Wrong agitation valve setting	Open agitation valve slightly until pressure goes to required range
	Tip too small for volume	Check Manufacturer's tip chart for proper size
Chemical system pressure too low.	Return hose plugged	Clean or replace hose
	Faulty pressure sensor	Calibrate sensor. Replace as required
	Faulty regulator	Repair or replace valve
	Wrong agitation valve	Close agitation valve slightly until pressure goes to required range
Check valves or screens plugging.	Dirty water	Flush and clean the system. Use clean water
	Poorly mixed chemicals	Mix chemicals more slowly. Follow mixing instructions
High spray drift.	Boom set too high	Lower boom
	Too windy	Wait until wind dies down
The pump does not draw Water.	Pump is airlocked	Bleed air from pump
	Suction line is plugged or collapsed	Examine suction line. Replace as required
	Pump faulty	Replace pump
Pressure reading fluctuates.	The pump is sucking in air through the intake or air has	Examine the suction hose and make sure it is firmly secured.

Problem	Cause	Solution
	not been entirely evacuated from the pump	Run the pump with the outlet hose open to evacuate air from pump
	Regulator broken	Replace regulator
The spray flow is irregular.	Filter screen plugged	Clean screens
	Nozzle screens plugged	Clean nozzle screens
Can't develop enough pressure.	Broken pressure regulator	Replace pressure regulator
	Worn pump	Repair or replace pump
	Leaking hose or fitting	Replace hose or tighten fitting
	Pump running too slowly	Increase oil flow to pump to increase pump speed
	Wrong agitation valve setting	Close agitation valve slightly until pressure goes to required range
	Tip size too large	Check tip capacity for proper size
No pressure reading.	Poor connection	Clean connection. Push firmly together
	Defective sensor	Replace sensor
	Defective controller gauge	Replace gauge
Spray won't shut off.	Defective switch in monitor	Replace switch
	Solenoid valve doesn't close	Magnet stuck or Spring broken. Replace defective parts
Controller doesn't control sprayer.	Blown fuse	Replace fuse
	Poor connection	Pull connections apart. Clean terminals. Reconnect
	No power	Connect power wire
	Refer to Controller Manual	Refer to Controller Manual
Booms bouncing.	Traveling too fast	Slow down



## TIGHTENING HARDWARE

Check the tightness of ALL BOLTS, U-BOLTS, and CAP SCREWS after the first 10-15 hours of operation and again at end of the first week (50 hours) of operation. Tighten all bolts to torques specified unless otherwise noted. Check tightness of hardware periodically.

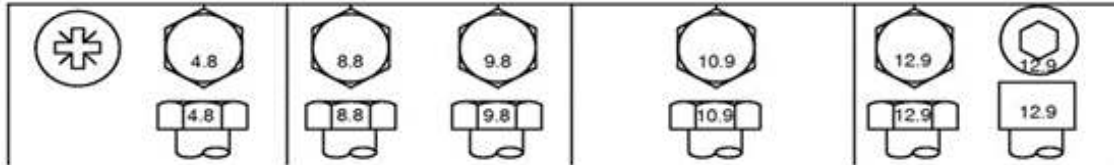

Figure 27: Common metric bolt grade markings

## Metric Bolt and Screw Torque Values

Screw Size	Class 4.8				Class 8.8 or 9.8				Class 10.9				Class 12.9			
	Lubricated <sup>1</sup>		Dry <sup>2</sup>		Lubricated <sup>1</sup>		Dry <sup>2</sup>		Lubricated <sup>1</sup>		Dry <sup>2</sup>		Lubricated <sup>1</sup>		Dry <sup>2</sup>	
	N-m	lb.-in.	N-m	lb.-in.	N-m	lb.-in.	N-m	lb.-in.	N-m	lb.-in.	N-m	lb.-in.	N-m	lb.-in.	N-m	lb.-in.
M6	4.7	42	6	53	8.9	79	11.3	100	13	115	16.5	146	15.5	137	19.5	172
									N-m	lb.-ft.	N-m	lb.-ft.	N-m	lb.-ft.	N-m	lb.-ft.
M8	11.5	102	14.5	128	22	194	27.5	243	32	23.5	40	29.5	37	27.5	47	35
			N-m	lb.-ft.	N-m	lb.-ft.	N-m	lb.-ft.								
M10	23	204	29	21	43	32	55	40	63	46	80	59	75	55	95	70
	N-m	lb.-ft.														
M12	40	29.5	50	37	75	55	95	70	110	80	140	105	130	95	165	120
M14	63	46	80	59	120	88	150	110	175	130	220	165	205	150	260	190
M16	100	74	125	92	190	140	240	175	275	200	350	255	320	235	400	300
M18	135	100	170	125	265	195	330	245	375	275	475	350	440	325	560	410
M20	190	140	245	180	375	275	475	350	530	390	675	500	625	460	790	580
M22	265	195	330	245	510	375	650	480	725	535	920	680	850	625	1080	800
M24	330	245	425	315	650	480	820	600	920	680	1150	850	1080	800	1350	1000
M27	490	360	625	460	950	700	1200	885	1350	1000	1700	1250	1580	1160	2000	1475
M30	660	490	850	625	1290	950	1630	1200	1850	1350	2300	1700	2140	1580	2700	2000
M33	900	665	1150	850	1750	1300	2200	1625	2500	1850	3150	2325	2900	2150	3700	2730
M36	1150	850	1450	1075	2250	1650	2850	2100	3200	2350	4050	3000	3750	2770	4750	3500

Torque values listed are for general use only, based on the strength of the bolt or screw. DO NOT use these values if a different torque value or tightening procedure is given for a specific application. For stainless steel fasteners or for nuts on U-bolts, see the tightening instructions for the specific application. Tighten plastic insert or crimped steel type lock nuts by turning the nut to the dry torque shown in the chart, unless different instructions are given for the specific application.

Shear bolts are designed to fail under predetermined loads. Always replace shear bolts with identical property class. Replace fasteners with the same or higher property class. If higher property class fasteners are used, tighten these to the strength of the original. Make sure fastener threads are clean and that you properly start thread engagement. When possible, lubricate plain or zinc plated fasteners other than lock nuts, wheel bolts, or wheel nuts, unless different instructions are given for the specific application.

<sup>1</sup> "Lubricated" means coated with a lubricant such as engine oil, fasteners with phosphate and oil coatings, or M20 and larger fasteners with JDM F13C, F13F or F13J zinc flake coating.

<sup>2</sup> "Dry" means plain or zinc plated without any lubrication, or M6 to M18 fasteners with JDM F13B, F13E or F13H zinc flake coating.

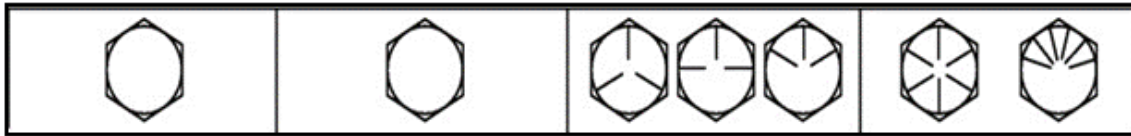

Figure 28: Common imperial bolt grade markings

## Unified Inch Bolt and Screw Torque Values

Screw Size	SAE Grade 1				SAE Grade 2 <sup>3</sup>				SAE Grade 5, 5.1 or 5.2				SAE Grade 8 or 8.2			
	Lubricated <sup>4</sup>		Dry <sup>5</sup>		Lubricated <sup>4</sup>		Dry <sup>5</sup>		Lubricated <sup>4</sup>		Dry <sup>5</sup>		Lubricated <sup>4</sup>		Dry <sup>5</sup>	
	N-m	lb.-in.	N-m	lb.-in.	N-m	lb.-in.	N-m	lb.-in.	N-m	lb.-in.	N-m	lb.-in.	N-m	lb.-in.	N-m	lb.-in.
1/4	3.7	33	4.7	42	6	53	7.5	66	9.5	84	12	106	13.5	120	17	150
													N-m	lb.-ft.	N-m	lb.-ft.
5/16	7.7	68	9.8	86	12	106	15.5	137	19.5	172	25	221	28	20.5	35	26
									N-m	lb.-ft.	N-m	lb.-ft.				
3/8	13.5	120	17.5	155	22	194	27	240	35	26	44	32.5	49	36	63	46
			N-m	lb.-ft.	N-m	lb.-ft.	N-m	lb.-ft.								
7/16	22	194	28	20.5	35	26	44	32.5	56	41	70	52	80	59	100	74
	N-m	lb.-ft.														
1/2	34	25	42	31	53	39	67	49	85	63	110	80	120	88	155	115
9/16	48	35.5	60	45	76	56	95	70	125	92	155	115	175	130	220	165
5/8	67	49	85	63	105	77	135	100	170	125	215	160	240	175	305	225
3/4	120	88	150	110	190	140	240	175	300	220	380	280	425	315	540	400
7/8	190	140	240	175	190	140	240	175	490	360	615	455	690	510	870	640
1	285	210	360	265	285	210	360	265	730	540	920	680	1030	760	1300	960
1-1/8	400	300	510	375	400	300	510	375	910	670	1150	850	1450	1075	1850	1350
1-1/4	570	420	725	535	570	420	725	535	1280	945	1630	1200	2050	1500	2600	1920
1-3/8	750	550	950	700	750	550	950	700	1700	1250	2140	1580	2700	2000	3400	2500
1-1/2	990	730	1250	930	990	730	1250	930	2250	1650	2850	2100	3600	2650	4550	3350
Torque values listed are for general use only, based on the strength of the bolt or screw. DO NOT use these values if a different torque value or tightening procedure is given for a specific application. For plastic insert or crimped steel type lock nuts, for stainless steel fasteners, or for nuts on U-bolts, see the tightening instructions for the specific application. Shear bolts are designed to fail under predetermined loads. Always replace shear bolts with identical grade.									Replace fasteners with the same or higher grade. If higher grade fasteners are used, tighten these to the strength of the original. Make sure fastener threads are clean and that you properly start thread engagement. When possible, lubricate plain or zinc plated fasteners other than lock nuts, wheel bolts, or wheel nuts, unless different instructions are given for the specific application.							

<sup>3</sup> Grade 2 applies for hex cap screws (not hex bolts) up to 6 in. (152 mm) long. Grade 1 applies for hex cap screws over 6 in. (152 mm) long, and for all other types of bolts and screws of any length.

<sup>4</sup> "Lubricated" means coated with a lubricant such as engine oil, fasteners with phosphate and oil coatings, or 7/8 in. and larger fasteners with JDM F13C, F13F or F13J zinc flake coating.

<sup>5</sup> "Dry" means plain or zinc plated without any lubrication, or 1/4 to 3/4 in. fasteners with JDM F13B, F13E or F13H zinc flake coating.

## Face Seal Fittings Assembly & Installation - All Pressure Applications

### Face Seal O-Ring to Stud End Installation

1. Inspect the fitting surfaces. They must be free of dirt and defects.
2. Inspect the O-ring. It must be free of damage and defects.
3. Lubricate the O-rings and install them into the groove using petroleum jelly to hold them in place.
4. Push the O-ring into the groove with petroleum jelly so that the O-ring is not displaced during assembly.
5. Index any angle fittings and tighten by hand, pressing the joint together to ensure that the O-ring remains in place.
6. Tighten the fitting or nut to the torque value shown on the chart per dash size stamped on the fitting. DO NOT allow hoses to twist when tightening fittings.

### Face Seal Adjustable Stud End O-Ring Installation

1. Back off the lock nut (jam nut) and washer to fully expose turned down section of the fitting.
2. Install a thimble over the fitting threads to protect the O-ring from nicks.
3. Slide the O-ring over the thimble into the turned down section of the fitting.
4. Remove thimble.

### Face Seal Straight Stud End O-Ring Installation

1. Install a thimble over the fitting threads to protect the O-ring from nicks.
2. Slide the O-ring over the thimble into the turned down section of the fitting.
3. Remove thimble.

### Fitting Installation

1. Install the fitting by hand until it is snug.
2. Position adjustable fittings by unscrewing the fitting no more than one turn.
3. Apply with an assembly torque per table.

### Assembly Torque

1. Use one wrench to hold the connector body and one wrench to tighten the nut.
2. For a hydraulic hose, it may be necessary to use three wrenches to prevent twist: one on the connector body, one on the nut, and one on the body of the hose fitting.

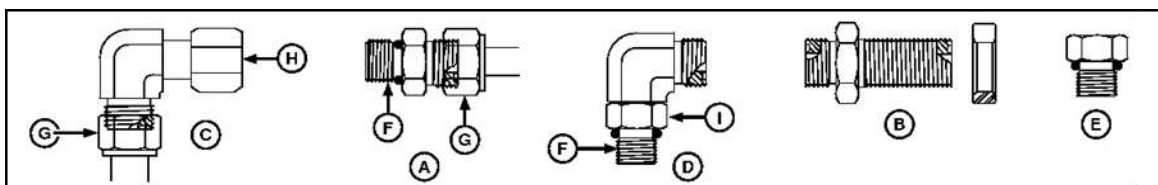

Figure 29: Common hydraulic fitting shapes and components

- |   |               |
|---|---------------|
| A. Stud Straight and Tube Nut           | G. Tube Nut   |
| B. Bulkhead Union and Bulkhead Lock Nut | H. Swivel Nut |
| C. 90° Swivel Elbow and Tube Nut        | I. Lock Nut   |
| D. 90° Adjustable Stud Elbow            |               |
| E. Port Plug                            |               |
| F. Stud End                             |               |



# TIGHTENING HARDWARE

## SAE Face Seal and O-Ring Stud End Fitting Torque Chart

SAE Face Seal and O-Ring Stud End Fitting Torque Chart - Standard Pressure-Below 27.6 MPA (4,000 PSI)																	
Nominal Tube OD Hose ID				O-Ring Face Seal/ Tube Swivel Nut				Bulkhead Jam Nut Torque			O-Ring Straight, Adjustable, and External Port Plug Stud Ends <sup>6</sup>						
Metric Tube OD	Inch Tube OD			Thread Size	Swivel Nut Hex Size	Tube Nut Swivel Nut Torque		Jam Nut Hex Size	Jam Nut Torque		Thread Size	Straight Hex Size <sup>7</sup>	Adj Lock Nut Hex Size	Steel or Gray Iron Torque		Aluminum or Brass Torque <sup>8</sup>	
	mm	Dash Size	in.	mm	in.	N-m	lb.- ft		N-m	lb.- ft	in.	in.	in.	N-m	lb.- ft	N-m	lb.-ft
5	-3	0.188	4.78	—	—	—	—	—	—	—	3/8-24	5/8	9/16	12	9	8	6
6	-4	0.250	6.35	9/16-18	11/16	16	12	13/16	32	24	7/16-20	5/8	5/8	16	12	11	8
8	-5	0.312	7.92	—	—	—	—	—	—	—	1/2-20	3/4	11/16	24	18	16	12
10	-6	0.375	9.53	11/16-16	13/16	24	18	1	42	31	9/16-18	3/4	3/4	37	27	25	18
12	-8	0.500	12.70	13/16-16	15/16	50	37	1-1/8	93	69	3/4-16	7/8	15/16	50	37	33	25
16	-10	0.625	15.88	1-14	1-1/8	69	51	1-5/16	118	87	7/8-14	1-1/16	1-1/16	69	51	46	34
20	-12	0.750	19.05	13/16-12	1-3/8	102	75	1-1/2	175	129	11/16-12	1-1/4	1-3/8	102	75	68	50
22	-14	0.875	22.23	13/16-12	—	102	75	—	175	129	13/16-12	1-3/8	1-1/2	122	90	81	60
25	-16	1.000	25.40	17/16-12	1-5/8	142	105	1-3/4	247	182	15/16-12	1-1/2	1-5/8	142	105	95	70
32	-20	1.25	31.75	1-11/16-12	1-7/8	190	140	2	328	242	1-5/8-12	1-3/4	1-7/8	190	140	127	93
38	-24	1.50	38.10	2-12	2-1/4	217	160	2-3/8	374	276	1-7/8-12	2-1/8	2-1/8	217	160	145	107
50.8	-32	2.000	50.80	—	—	—	—	—	—	—	2-1/2-12	2-3/4	2-3/4	311	229	207	153

<sup>6</sup> Tolerance is +15%/-20% of mean tightening torque unless otherwise specified.

<sup>7</sup> The straight hex wrench sizes listed apply to connectors only and may not be the same as the corresponding plug of the same thread size.

<sup>8</sup> These torques were established using steel plated connectors in aluminum and brass.



Fast Ag Solutions  
4130 Commerce Boulevard  
Windom, MN 56101

1-800-772-9279 Toll Free

1-507-427-3861 Voice

1-507-427-3030 Fax

<https://fastagsolutions.com/>