

fast

DISTRIBUTING
INC.



FLAT-FOLD 3 POINT HITCH FIELD SPRAYER

MODELS

4013, 4515, 6015, 6020, 8020, 9020

and

500 gal, 750 gal, 1000 gal, 1600 gal Tanks

OPERATOR'S MANUAL

LIMITED WARRANTY

Fast Distributing Inc. warrants to the buyer that the new machinery is free from defects in material and workmanship.

This warranty is only effective as to any new machinery which has not been altered, changed, repaired or treated since its delivery to the buyer, other than by FAST DISTRIBUTING or its authorized dealers or employees, and does not apply to accessories, attachments, tools or parts, sold or operated with the new machinery, if they have not been manufactured by FAST DISTRIBUTING.

FAST DISTRIBUTING shall only be liable for defects in the materials or workmanship attributable to faulty material or bad workmanship that can be proved by the buyer, and specifically excludes liability for repairs arising as a result of normal wear and tear of the new machinery or in any other manner whatsoever, and without limiting the generality of the foregoing, excludes application or installation of parts not completed in accordance with FAST DISTRIBUTING operator's manual, specifications, or printed instructions.

Written notice shall be given by registered mail, to FAST DISTRIBUTING within seven (7) days after the defect shall have become apparent or the repairs shall have become necessary, addressed as follows: FAST DISTRIBUTING INC. Rt2, Box 325, Mountain Lake, MN 56159.

This warranty shall expire one (1) year after the date of delivery of the new machinery.

If these conditions are fulfilled, FAST shall at its own cost and at its own option either repair or replace any defective parts provided that the buyer shall be responsible for all expenses incurred as a result of repairs, labour, parts, transportation or any other work, unless FAST has authorized such expenses in advance.

The warranty shall not extend to any repairs, changes, alterations, or replacements made to the new equipment other than by FAST or its authorized dealers or employees.

This warranty extends only to the original owner of the new equipment.

Rubber parts are not warranted. (including tires, hoses, grommets)

This warranty is limited to the terms stated herein and is in lieu of any other warranties whether express or implied, and without limiting the generality of the foregoing, excluded all warranties, express or implied or conditions whether statutory or otherwise as to quality and fitness for any purpose of the new equipment. FAST disclaims all liability for incidental or consequential damages.

This sprayer is subject to design changes and FAST DISTRIBUTING INC. shall not be required to retro-fit or exchange items on previously sold units except at its own option.

FAST DISTRIBUTING INC.

TABLE OF CONTENTS

SECTION	DESCRIPTION	PAGE
1	Introduction	1
2	Safety	2
2.1	General Safety	3
2.2	Operating Safety	4
2.3	Chemical Safety	5
2.4	Maintenance Safety	6
2.5	Hydraulic Safety	6
2.6	Tire Safety	6
2.7	Transport Safety	7
2.8	Storage Safety	7
2.9	Safety Decals	7
2.10	Sign-Off Form	8
3	Safety Decal Locations	9
4	Operation	12
4.1	To the New Operator or Owner	12
4.2	Machine Components	13
4.3	Break-In	14
4.4	Pre-Operation Checklist	14
4.5	Equipment Matching	15
4.6	Controls	16
4.7	Installing Controllers	20
4.8	Attaching/Unhooking Tractor	21
4.8.1	Sprayer Ahead Of Caddy	21
4.8.2	Caddy Ahead Of Sprayer	24
4.9	Sprayer Calibration	26
4.9.1	Engine RPM	26
4.9.2	Controller Calibration	27
4.9.3	Nozzle Calibration	27
4.9.4	Machine Yard Calibration	29
4.9.5	Ground Speed Calibration	29
4.9.6	Area Covered	31
4.9.7	Field Calibration	31
4.10	Field Operation	32
4.11	Transport/Field Conversion	41
4.12	Transport	42
4.13	Storage	43
4.13.1	Placing In Storage	43
4.13.2	Removing From Storage	44
5	Service and Maintenance	45
5.1	Service	45
5.1.1	Fluids and Lubricants	45
5.1.2	Greasing	45
5.1.3	Servicing Intervals	46
5.1.4	Service Record	49
5.2	Maintenance	50

SECTION	DESCRIPTION	PAGE
	5.2.1 Filter Cleaning	50
	5.2.2 Tank Cleaning	51
	5.2.3 Nozzle/Wing Height	52
	5.2.4 Wing Alignment	53
	5.2.5 Caddy 3 Point Hitch	54
6	Trouble Shooting	55
7	Options	58
7.1	Foam Markers	58
7.2	Flush Tank	58
7.3	Chemical Circuit Controller	58
7.4	Caddy 3 Point Hitch	58
8	Specifications	59
8.1	Mechanical	59
8.2	Bolt Torque	61
8.3	Hydraulic Fitting Torque	61
8.4	Chemical Circuit Schematic	62
9	Index	63

SERIAL NUMBER LOCATION

Always give your dealer the serial number of your Fast Distributing 3 Point Hitch Field Sprayer when ordering parts or requesting service or other information.

The serial number is stamped into the frame where indicated. Please mark the number in the space provided for easy reference.

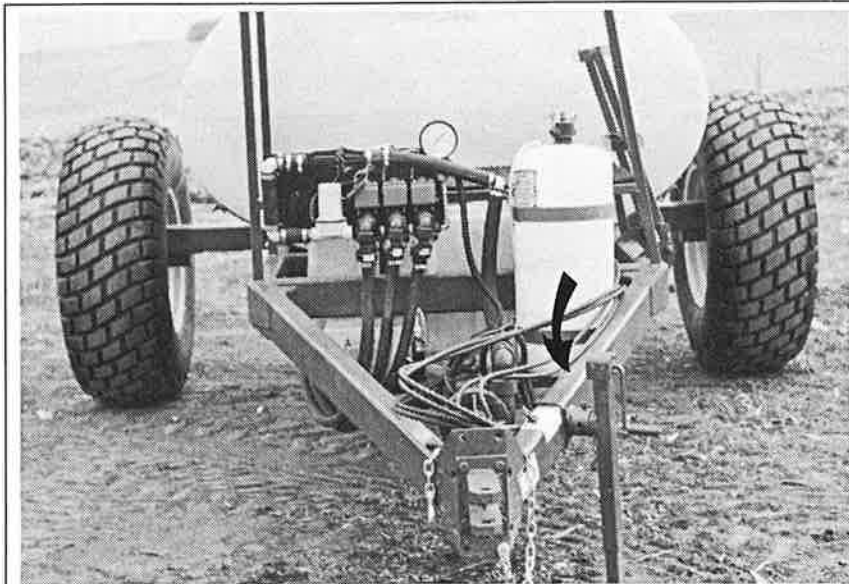

CADDY

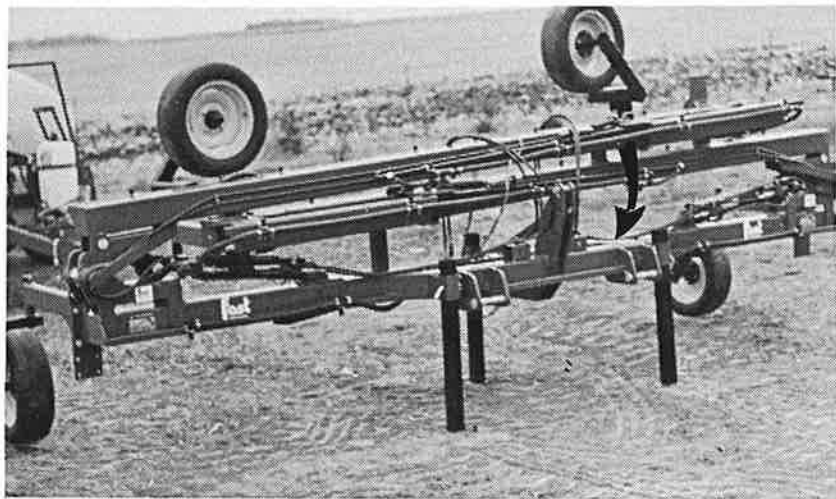

SPRAYER

SERIAL NUMBER LOCATION

Model Number _____

Caddy Serial Number _____

Sprayer Serial Number _____

1 INTRODUCTION

Congratulations on your choice of a Fast Distributing Flat-Fold 3 Point Hitch Field Sprayer to complement your farming operation. This equipment has been designed and manufactured to meet the needs of a discriminating buyer for the efficient spraying of crops.

Safe, efficient and trouble free operation of your Fast Distributing Field Sprayer requires that you and anyone else who will be operating or maintaining the Sprayer, read and understand the Safety, Operation, Maintenance and Trouble Shooting information contained in the Operator's Manual.

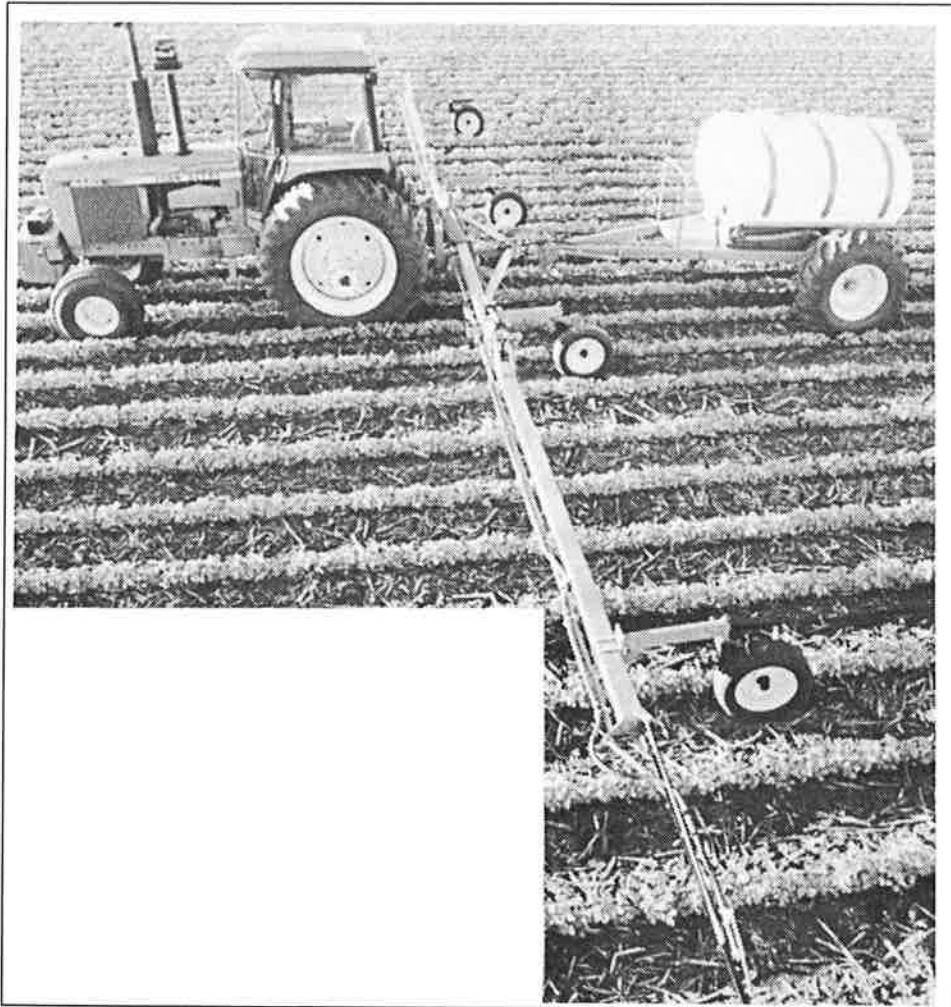

This manual covers all Flat-Fold 3 Point Hitch Field Sprayers and Spray Trailers built by Fast Distributing. Use the Table of Contents or Index as a guide when searching for specific information.

Keep this manual handy for frequent reference and to pass on to new operators or owners. Call your Fast dealer or distributor if you need assistance or information.

OPERATOR ORIENTATION - The directions left, right, front and rear, as mentioned throughout this manual, are as seen from the tractor driver's seat and facing in the direction of travel.

2 SAFETY

SAFETY ALERT SYMBOL

This Safety Alert symbol means
ATTENTION! BECOME ALERT!
YOUR SAFETY IS INVOLVED!

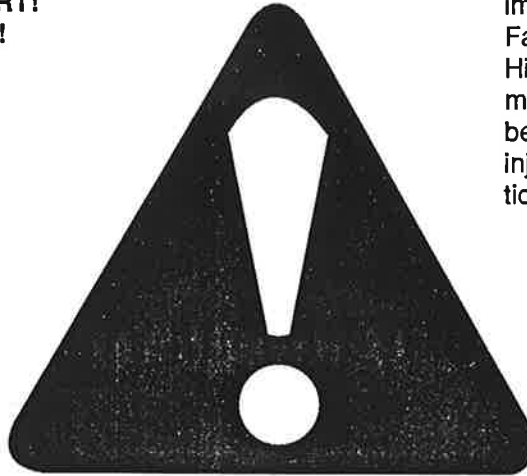

The Safety Alert symbol identifies important safety messages on the Fast Distributing Flat-Fold 3 Point Hitch Field Sprayer and in the manual. When you see this symbol, be alert to the possibility of personal injury or death. Follow the instructions in the safety message.

Why is SAFETY important to you?

3 Big Reasons

Accidents Disable and Kill
Accidents Cost
Accidents Can Be Avoided

SIGNAL WORDS:

Note the use of the signal words **DANGER**, **WARNING** and **CAUTION** with the safety messages. The appropriate signal word for each message has been selected using the following guide-lines:

DANGER - An immediate and specific hazard which **WILL** result in severe personal injury or death if the proper precautions are not taken.

WARNING - A specific hazard or unsafe practice which **COULD** result in severe personal injury or death if proper precautions are not taken.

CAUTION - Unsafe practices which **COULD** result in personal injury if proper practices are not taken, or as a reminder of good safety practices.

SAFETY

YOU are responsible for the **SAFE** operation and maintenance of your Fast Distributing Flat-Fold 3 Point Hitch Field Sprayer. **YOU** must ensure that you and anyone else who is going to operate, maintain or work around the Sprayer be familiar with the operating and maintenance procedures and related **SAFETY** information contained in this manual. This manual will take you step-by-step through your working day and alerts you to all good safety practices that should be adhered to while operating the Sprayer.

Remember, **YOU** are the key to safety. Good safety practices not only protect you but also the people around you. Make these practices a working part of your safety program. Be certain that **EVERYONE** operating this equipment is familiar with the recommended operating and maintenance procedures and follows all the safety precautions. Most accidents can be prevented. Do not risk injury or death by ignoring good safety practices.

- Sprayer owners must give operating instructions to operators or employees before allowing them to operate the Sprayer, and at least annually thereafter per OSHA regulation 1928.57.
- The most important safety device on this equipment is a **SAFE** operator. It is the operator's responsibility to read and understand **ALL** Safety and Operating instructions in the manual and to follow these. All accidents can be avoided.
- A person who has not read and understood all operating and safety instructions is not qualified to operate the machine. An untrained operator exposes himself and bystanders to possible serious injury or death.
- Do not modify the equipment in any way. Unauthorized modification may impair the function and/or safety and could affect the life of the equipment.
- Think **SAFETY!** Work **SAFELY!**

2.1 GENERAL SAFETY

1. Read and understand the Operator's Manual and all safety signs before operating, maintaining or adjusting the Sprayer.



2. Only trained competent persons shall operate the Sprayer. An untrained operator is not qualified to operate the machine.

3. Have a first-aid kit available for use should the need arise and know how to use it.



4. Do not allow riders.

5. Wear appropriate protective gear. This list includes but is not limited to:

- A hard hat
- Rubber boots
- Protective goggles
- Neoprene gloves
- Water repellent clothing
- Respirator or filter mask

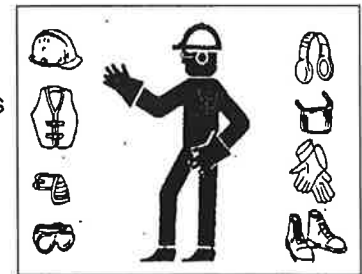

6. Place all controls in neutral, stop tractor engine, turn monitor off, set park brake, remove ignition key, wait for nozzles to stop spraying before servicing, adjusting, repairing or unplugging.
7. Read chemical manufacturers warnings, instructions and procedures before starting and follow them exactly.
8. Post Poison Control Emergency telephone number for your area on sprayer before using Agricultural chemicals.

Ottawa: (613) 992-5606
Washington DC: (202) 962-4525

Have container label handy when seeking medical attention.

9. Review safety related items with all personnel annually.

2.2 OPERATING SAFETY

1. Read and understand the Operator's Manual and all safety signs before using.
2. Place all controls in neutral, stop tractor engine, turn monitor off, set park brake, remove ignition key, wait for nozzles to stop spraying before servicing, adjusting, repairing or unplugging.
3. Before spraying a field, be familiar with all potential hazards: trees, rocks, ditches, gullies, etc. Plan the spraying route to avoid hazards. Remember you are driving a wide machine. USE CAUTION WHEN CORNERING.
4. Keep hands, feet, hair and clothing away from all moving and/or rotating parts.
5. Do not allow riders on the sprayer or tractor during operation or transporting.
6. Stay away from overhead obstructions and power lines when extending or folding wings. Electrocution can occur without direct contact.
7. Caddy hitch can upend. Do not stand over hitch when unhooking. Support hitch and sprayer on stands before removing pin.
8. Attach securely to towing. Install retainers through pins and attach safety chain.
9. Stay away from wing pinch points when folding or extending wings. Keep others away.
10. Clear the area of all bystanders, especially children, before starting or filling with water or chemical.
11. Read chemical manufacturers warnings, instructions and procedures before starting and follow them exactly.
12. Do not breathe, touch or ingest chemicals. Always wear protective clothing and follow safe handling procedures.
13. Spray only when potential for chemical drift is at a minimum. Even small amounts can affect neighboring crops or sensitive plants and people.
14. Dispose of chemical containers by triple rinsing them into the sprayer tank or thoroughly rinsing, crushing and delivering to regional disposal site.
15. In case of poisoning, get immediate medical attention.
16. Only rinse sprayer while still in the field. Spray the rinse thinly over the field already sprayed. Never contaminate the farmyard or drainage systems with sprayer rinse.
17. Do not eat in the field when spraying.
18. Before applying pressure to the hydraulic system, make sure all components are tight and that steel lines, hoses and couplings are in good condition.
19. Before applying pressure to chemical system make sure that all connections are tight and that all hoses and fittings are in good condition.
20. Review safety instructions annually.

2.3 CHEMICAL SAFETY

1. Some Agricultural chemicals are among the most toxic substances known to man. Minute quantities can contaminate clothing, machinery, the workplace and the environment. Follow the chemical manufacturers' instructions exactly. Death can result from their improper use.
2. Misuse, including excessive rates, uneven application, wind drift, and label violations can cause injury to crops, livestock, persons and the environment.
3. Do not breathe, touch or ingest chemicals, Always wear protective clothing and follow safe handling procedures.
4. Follow the manufacturers' instructions for chemical storage. Avoid unnecessary storage by purchasing only the quantity needed for the crop year.
5. Keep all chemicals out of reach of children and away from livestock and animals.
6. Store chemicals only in their original containers and in a locked area.
7. Check with state environment department regarding the disposal of small quantities of chemicals, chemical containers and wash water.
8. Do not burn the containers or leave them lying in the field or ditches. Dispose of them by triple rinsing and leaving at a pesticide container disposal site.
9. Wash thoroughly before eating. Use a detergent to remove all chemical residue. Rinse carefully and dry with disposable towels.
10. Do not eat in the field when spraying.
11. In case of chemical poisoning, get immediate medical attention. Have container label handy when seeking medical attention.
12. Post Poison Control Emergency telephone number for your area on sprayer before using Agricultural chemicals.

Ottawa: (613) 992-5606
Washington DC: (202) 962-4525

Have container label handy when seeking medical attention.
13. Thoroughly wash clothing and equipment contaminated by chemicals.
14. Do not allow children or workers on contaminated sprayer.
15. Rinse sprayer while still in the field. Spray the rinse thinly over the field already sprayed. Never contaminate the farmyard or drainage systems with sprayer rinse.
16. Do not use the sprayer to transport drinking water.
17. Wash down the Sprayer immediately after field work. Dispose of the wash water in an environmentally safe manner. Wash water can contaminate the soil or a clean water supply.

2.4 MAINTENANCE SAFETY

1. Review the Operator's Manual and all safety items before working with, maintaining or operating the Sprayer.
2. Place all controls in neutral, stop the tractor engine, turn monitor off, set park brake, remove ignition key, wait for nozzles to stop spraying before servicing, adjusting, repairing or unplugging.
3. Follow good shop practices:

- Keep service area clean and dry.
- Be sure electrical outlets and tools are properly grounded.
- Use adequate light for the job at hand.



4. Before applying pressure to a hydraulic system, make sure all components are tight and that steel lines, hoses and couplings are in good condition.
5. Before applying pressure to chemical system make sure that all connections are tight and that all hoses and fittings are in good condition.
6. Relieve pressure from hydraulic circuit before servicing or disconnecting from tractor.
7. Keep hands, feet, clothing and hair away from all moving and/or rotating parts.
8. Clear the area of bystanders, especially children, when carrying out any maintenance and repairs or making any adjustments or filling.
9. Place stands or blocks under the frame before working beneath the machine.
10. Wear safety goggles, neoprene gloves and protective clothing when working on the sprayer filled with active chemical.
11. Wash machine to remove all chemical residue before working on unit. Wear appropriate protective gear at all times.
12. Protect yourself from chemical contamination.

2.5 HYDRAULIC SAFETY

1. Always place all tractor hydraulic controls in neutral before dismounting.
2. Make sure that all components in the hydraulic system are kept in good condition and are clean.
3. Replace any worn, cut, abraded, flattened or crimped hoses and steel lines.
4. Do not attempt any makeshift repairs to the hydraulic lines, fittings or hoses by using tape, clamps or cements. The hydraulic system operates under extremely high-pressure. Such repairs will fail suddenly and create a hazardous and unsafe condition.
5. Wear proper hand and eye protection when searching for a high-pressure hydraulic leak. Use a piece of wood or cardboard as a backstop instead of hands to isolate and identify a leak.
6. If injured by a concentrated high-pressure stream of hydraulic fluid, seek medical attention immediately. Serious infection or toxic reaction can develop from hydraulic fluid piercing the skin surface.
7. Before applying pressure to the system, make sure all components are tight and that lines, hoses and couplings are in good condition.

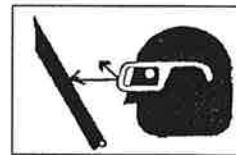

2.6 TIRE SAFETY

1. Failure to follow proper procedures when mounting a tire on a wheel or rim can produce an explosion which may result in serious injury or death.
2. Do not attempt to mount a tire unless you have the proper equipment and experience to do the job.
3. Have a qualified tire dealer or repair service perform required tire maintenance.

2.7 TRANSPORT SAFETY

1. Read and understand ALL the information in the Operator's Manual regarding procedures and SAFETY when operating the Sprayer in the field and/or on the road.
2. Check with local authorities regarding sprayer transport on public roads. Obey all applicable laws and regulations.
3. Always travel at a safe speed. Use caution when making corners or meeting traffic.
4. Make sure the SMV (Slow Moving Vehicle) emblem and all the lights and reflectors that are required by the local highway and transport authorities are in place, are clean and can be seen clearly by all overtaking and oncoming traffic.
5. Install additional lights on the rear of the sprayer to safeguard against rear end collisions. Daybreak and dusk are particularly dangerous and pilot vehicles are recommended.
6. Be sure that the Sprayer is hitched positively to the towing vehicle and a retainer is used through each mounting pins. Always attach a safety chain between the caddy and the towing machine.
7. Be sure wing frames are over center and rest against their supports before transporting.
8. Keep to the right and yield the right-of-way to allow faster traffic to pass. Drive on the road shoulder, if permitted by law.
9. Do not exceed 20 mph (32 km/h). Reduce speed on rough roads and surfaces.
10. Always use hazard warning flashers on tractor when transporting unless prohibited by law.
11. Never transport with the tank filled with water or chemical.

2.8 STORAGE SAFETY

1. Store unit in an area away from human activity.
2. Do not permit children to play on or around the stored sprayer.
3. Install frame legs and secure with pins before unhooking from tractor.

2.9 SAFETY DECALS

1. Keep safety decals and signs clean and legible at all times.
2. Replace safety decals and signs that are missing or have become illegible.
3. Replaced parts that displayed a safety sign should also display the current sign.
4. Safety decals or signs are available from your Dealer Parts Department.

How to Install Safety Decals:

- Be sure that the installation area is clean and dry.
- Decide on the exact position before you remove the backing paper.
- Remove the smallest portion of the split backing paper.
- Align the decal over the specified area and carefully press the small portion with the exposed sticky backing in place.
- Slowly peel back the remaining paper and carefully smooth the remaining portion of the decal in place.
- Small air pockets can be pierced with a pin and smoothed out using the piece of decal backing paper.

3 SAFETY DECAL LOCATIONS

The types of decals and locations on the equipment are shown in the illustration below. Good safety requires that you familiarize yourself with the various Safety Decals, the type of warning and the area, or particular function related to that area, that requires your SAFETY AWARENESS.

- Think SAFETY! Work SAFELY!

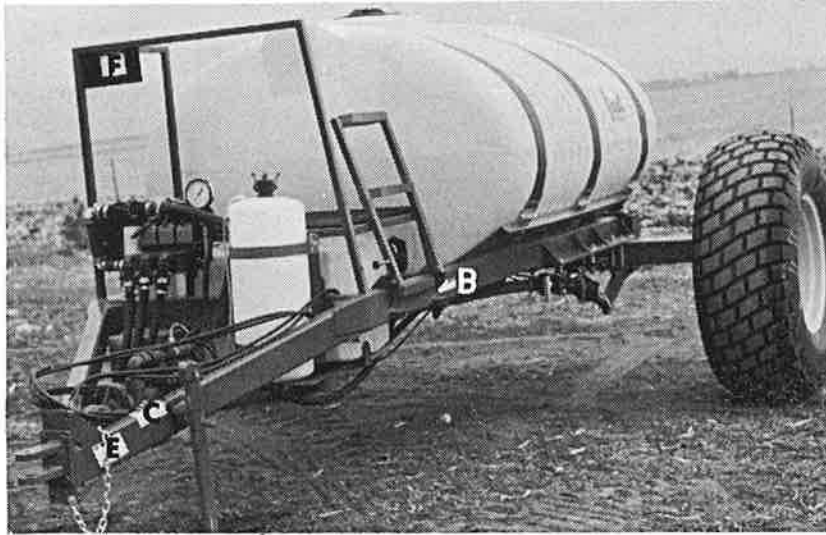

A

CAUTION

1. Read and understand the Operator's Manual before using.
2. Read Chemical manufacturers' WARNINGS, Instructions and procedures before starting and follow them exactly.
3. Stop tractor engine, place all controls in neutral, set park brake, remove Ignition key and wait for all moving parts to stop before servicing, adjusting, repairing, unplugging or filling.
4. Always wear proper eye, breathing and clothing protection.
5. Stay away from chemicals, spray and drift. Keep others away.
6. Install and secure all guards before starting.
7. Keep hands, feet, hair and clothing away from moving parts.
8. Do not allow riders.
9. Keep all chemical and hydraulic lines, fittings and couplers tight and free of leaks before starting and operating.
10. Stay away from overhead power lines. Electrocutation can occur without direct contact.
11. Clear the area of bystanders before extending or folding wings.
12. Release second wing extend switch before folding first wing.
13. Hitch can upend. Do not stand over hitch when unhooking. Support hitch and sprayer on stands before removing pin.
14. Review Safety Instructions with all operators annually.

800

B

WARNING



FALLING HAZARD

To prevent serious injury or death from falling:

1. Use care when climbing ladder or working on platform.
2. Keep unauthorized people off machine.

801

C

WARNING

HIGH-PRESSURE FLUID HAZARD

To prevent serious injury or death from high-pressure fluid:

1. Relieve pressure on system before repairing, adjusting or disconnecting.
2. Wear proper hand and eye protection when searching for leaks. Use wood or cardboard instead of hands.
3. Keep all components in good repair.

802

REMEMBER - If Safety Decals have been damaged, removed, become illegible or parts replaced without decals, new decals must be applied. New decals are available from your authorized dealer.

The types of decals and locations on the equipment are shown in the illustration below. Good safety requires that you familiarize yourself with the various Safety Decals, the type of warning and the area, or particular function related to that area, that requires your SAFETY AWARENESS.

- Think SAFETY! Work SAFELY!

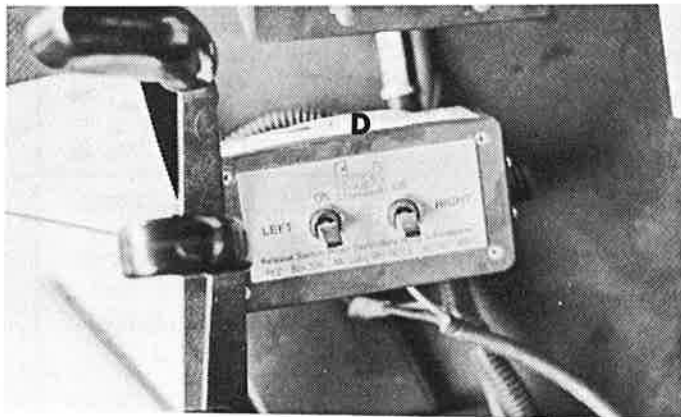
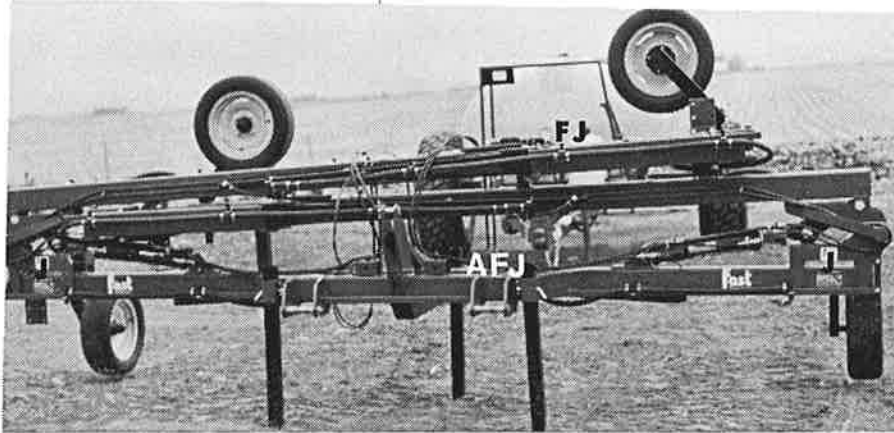

E

WARNING

UPENDING HAZARD

To prevent serious injury or death from upending hazard:

1. Do not unhook caddy unless sprayer and hitch are supported on stands.
2. Do not stand over hitch when unhooking.

804

D

WARNING

WING EXTEND HAZARD

To prevent serious injury or death:

1. Never turn switch ON unless main wing is fully extended.
2. Have second wing folded in and switch OFF before main wing folds over-center.

803

F

DANGER

**ELECTROCUTION HAZARD
KEEP AWAY FROM POWER LINES**

To prevent serious injury or death from electrocution:

1. Stay well away from power lines when folding or extending wings. Electrocution can occur without direct contact.
2. Lower wings completely before moving or transporting.

805



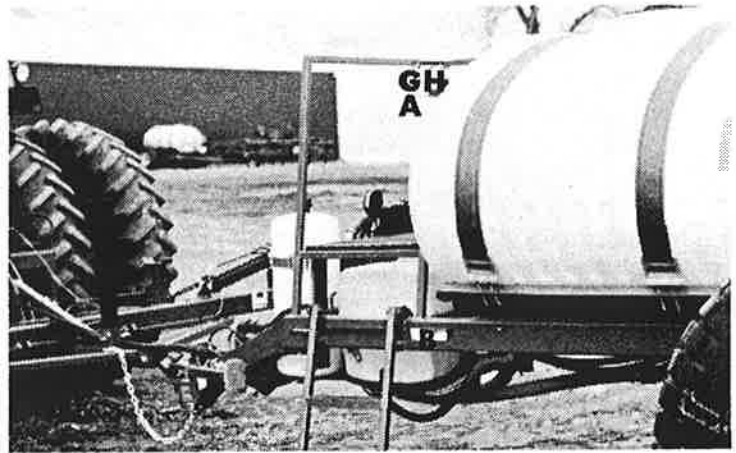

REMEMBER - If Safety Decals have been damaged, removed, become illegible or parts replaced without decals, new decals must be applied. New decals are available from your authorized dealer.

The types of decals and locations on the equipment are shown in the illustration below. Good safety requires that you familiarize yourself with the various Safety Decals, the type of warning and the area, or particular function related to that area, that requires your SAFETY AWARENESS.

- Think SAFETY! Work SAFELY!



G

 DANGER		
		
CHEMICAL HAZARD		
To prevent serious injury or death:		
WEAR RUBBER GLOVES	DON'T BREATHE VAPOR	DON'T INGEST CHEMICAL
<ol style="list-style-type: none"> 1. Do not allow chemical or solution to touch skin. Some can be absorbed through the skin. 2. Wear rubber gloves and protective gear at all times. 	<ol style="list-style-type: none"> 1. Stay away from chemical splash and vapor. Keep others away. 2. Do not breathe vapor. 3. Wear proper respirator when working with chemicals. 	<ol style="list-style-type: none"> 1. Chemicals can be toxic. 2. If in eyes or mouth, read chemical manufacturers' instructions and follow them exactly. 3. Seek medical attention immediately. 4. A poison control number is normally inside the front cover of your telephone book. 806

H

 WARNING
TOXIC CHEMICAL HAZARD
Agricultural chemicals can be dangerous. Improper selection or use can seriously injure persons, animals, plants, soil or other property. BE SAFE: Select the right chemical for the job. Handle it with care. Follow the instructions on the container label and instructions from the equipment manufacturer. 807

J

 WARNING

OVERHEAD HAZARD KEEP AWAY
To prevent serious injury or death from overhead hazard:
<ol style="list-style-type: none"> 1. Stay away from machine when extending or folding wings. 2. Keep others away. 3. Move wings only from tractor seat. 808

REMEMBER - If Safety Decals have been damaged, removed, become illegible or parts replaced without decals, new decals must be applied. New decals are available from your authorized dealer.

4 OPERATION



OPERATING SAFETY

1. Read and understand the Operator's Manual and all safety signs before using.
2. Place all controls in neutral, stop tractor engine, turn monitor off, set park brake, remove ignition key, wait for nozzles to stop spraying before servicing, adjusting, repairing or unplugging.
3. Before spraying a field, be familiar with all potential hazards: trees, rocks, ditches, gullies, etc. Plan the spraying route to avoid hazards. Remember you are driving a wide machine. USE CAUTION WHEN CORNERING.
4. Keep hands, feet, hair and clothing away from all moving and/or rotating parts.
5. Do not allow riders on the sprayer or tractor during operation or transporting.
6. Stay away from overhead obstructions and power lines when extending or folding wings. Electrocutation can occur without direct contact.
7. Caddy hitch can upend. Do not stand over hitch when unhooking. Support hitch and sprayer on stands before removing pin.
8. Attach securely to towing. Install retainers through pins and attach safety chain.
9. Stay away from wing pinch points when folding or extending wings. Keep others away.
10. Clear the area of all bystanders, especially children, before starting or filling with water or chemical.
11. Read chemical manufacturers warnings, instructions and procedures before starting and follow them exactly.
12. Do not breathe, touch or ingest chemicals. Always wear protective clothing and follow safe handling procedures.
13. Spray only when potential for chemical drift is at a minimum. Even small amounts can affect neighboring crops or sensitive plants and people.
14. Dispose of chemical containers by triple rinsing them into the sprayer tank or thoroughly rinsing, crushing and delivering to regional disposal site.
15. In case of poisoning, get immediate medical attention.
16. Only rinse sprayer while still in the field. Spray the rinse thinly over the field already sprayed. Never contaminate the farmyard or drainage systems with sprayer rinse.
17. Do not eat in the field when spraying.
18. Before applying pressure to the hydraulic system, make sure all components are tight and that steel lines, hoses and couplings are in good condition.
19. Before applying pressure to chemical system make sure that all connections are tight and that all hoses and fittings are in good condition.
20. Review safety instructions annually.

4.1 TO THE NEW OPERATOR OR OWNER

Today's Agricultural industry works closely with the chemical industry to develop and use the appropriate compound for control of insects, weeds and fungus. Effective results are closely related to application methods and techniques. Fast Distributing Inc. has designed a field sprayer that will place the chemicals exactly where they are needed.

It is the responsibility of the owner or operator to read this manual and the chemical container label before starting. Follow all safety instructions exactly. Safety is every-

one's business. By following recommended procedures, a safe working environment is provided for the operator, bystanders and the environment.

Many features incorporated into this machine are the result of suggestions made by customers like you. Read this manual carefully to learn how to operate the machine safely and how to set it to provide maximum field efficiency. By following the operating instructions in conjunction with a good maintenance program, your Sprayer will provide many years of trouble-free service.

4.2 MACHINE COMPONENTS

The Fast Distributing Field Sprayer consists of two major components: a large transportable tank on a caddy and a set of folding wings for distributing the chemicals. The folding spray bar can be attached to the 3 point hitch on the tractor or the optional 3 point hitch on the caddy.

The circuit (optional) is plumbed into the tank for agitation to keep the solution mixed. A solenoid to each wing controls the flow to the wings and a butterfly valve and pressure sensor maintains the system pressure. Nozzles along the wings, distribute the chemical solution over the field. A screen in the line next to the pump and after of the solenoids removes contaminants from the system. A control box in the cab displays the chemical circuit pressure, increases or decreases the pressure and turns the flow to the wings on and off.

The first wing folds over-center and lays flat on the center section for transport and storage. The second wing folds in parallel to the first wing.

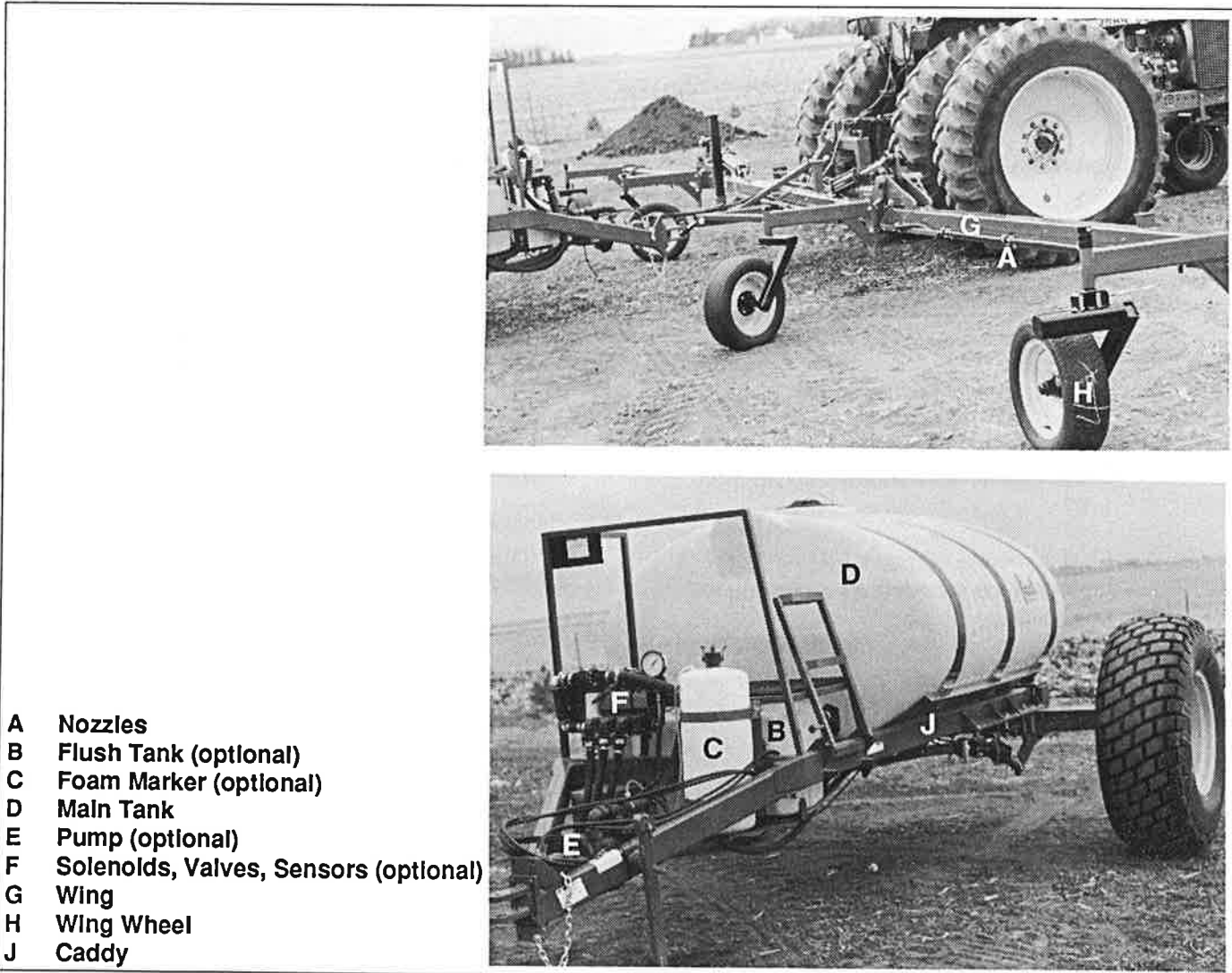

- A Nozzles
- B Flush Tank (optional)
- C Foam Marker (optional)
- D Main Tank
- E Pump (optional)
- F Solenoids, Valves, Sensors (optional)
- G Wing
- H Wing Wheel
- J Caddy

Fig. 1 MACHINE COMPONENTS

4.3 BREAK-IN

Although there are no operational restrictions on the sprayer when used for the first time, it is recommended that the following mechanical items be checked:

- A. After operating for 1/2 hour
 - 1. Retorque all the wheel bolts.
 - 2. Retorque all other fasteners and hardware.
 - 3. Check that all electrical connections are tight.
 - 4. Check that no chemical or hydraulic lines are being pinched or crimped. Re-align as required.
 - 5. Check that all nozzles are working properly. Clean or replace as required.
 - 6. Check that the wing height adjusters are tight
 - 7. Lubricate all grease fittings.
- B. After 5 hours and 10 hours of operation
 - 1. Retorque all wheel bolts, fasteners and hardware.
 - 2. Check chemical and hydraulic line routing.
 - 3. Check that all nozzles are working properly.
 - 4. Then go to the normal servicing and maintenance schedule as defined in the Maintenance Section.

4.4 PRE-OPERATION CHECKLIST

Efficient and safe operation of the Fast Distributing Sprayer requires that each operator reads and understands the operating procedures and all related safety precautions outlined in this section. A pre-operational checklist is provided for the operator. It is important for both personal safety and maintaining the good mechanical condition of the Sprayer that this checklist be followed.

Before operating the Sprayer and each time thereafter, the following areas should be checked off:

- 1. Lubricate the machine per the schedule outlined in the "Maintenance Section".
- 2. Use only a tractor of adequate power and weight to operate the Sprayer. See Section 4.5.1 for recommendations.
- 3. Ensure that the machine is properly attached to the tractor. Use retainers through the mounting and drawbar pins. Attach the safety chain between the caddy and towing unit.
- 4. Check the hydraulic system. Ensure that the hydraulic reservoir in the tractor is filled to the required specifications.
- 5. Inspect all hydraulic lines, hoses, fittings and couplers for tightness. Use a clean cloth to wipe any accumulated dirt from the couplers before connecting to the hydraulic system of the tractor.
- 6. Check the condition and routing of all chemical hoses and lines. Replace any that are damaged. Re-route those that are rubbing, pinched or crimped.
- 7. Check the tires and be sure they are inflated to their specified pressure.
- 8. Calibrate the sprayer if it is the start of the season or a new chemical is being used.
- 9. Check the spray pattern of each nozzle. Remove and clean or replace any that have an unusual pattern.
- 10. Remove the steel mesh line filters and wash with clean water. Reinstall.
- 11. Check that all connections in the electrical system are connected and tight.
- 12. Perform a functional check on the hydraulic system. Be sure the wings can easily raise and fold without binding.

4.5 EQUIPMENT MATCHING

To insure the safe and reliable operation of the Sprayer, it is necessary to use a tractor with appropriate specifications. As a guideline, insure that these requirements are met:

1. Tractor Horsepower:

Although horsepower requirements will increase as the machine size increases it is recommend that the tractor have a minimum of 100 hp for normal operation and 125 hp if operating in hilly terrain. Although the power is not required to pull the machine, it will insure sufficient 3 point lift capacity and that the tractor/sprayer combination has sufficient power to maintain a constant forward speed under all operating conditions and stability during all operating and transporting conditions.

2. 3 Point Hitch

The tractor must be equipped with a Category II or III 3 point hitch or one that is convertible to either. It is also recommended that a Quick Hitch be installed on the 3 point to make machine attachment easy.

3. Drawbar:

The tractor drawbar must be set to provide 16 inches (406 mm) between the end of the PTO shaft and the center of the drawbar pin. Refer to your tractor manual for the adjustment procedure. Although the PTO is not used, this dimension must be maintained to provide sufficient clearance between the hitch and tractor tire when turning.

4. Hydraulic System:

The tractor hydraulic system must be capable of 5 gpm (14 lpm) at 2000 psi (13,800 kPa) to operate the chemical circuit pump. Either closed-center or open-centered systems can be used. However an open centered hydraulic system is limited to 8 gpm maximum.

NOTE

Contact factory for an optional flow control for use with high flow open center system.

An outlet for the wing fold on each side and the sprayer pump circuits are required.

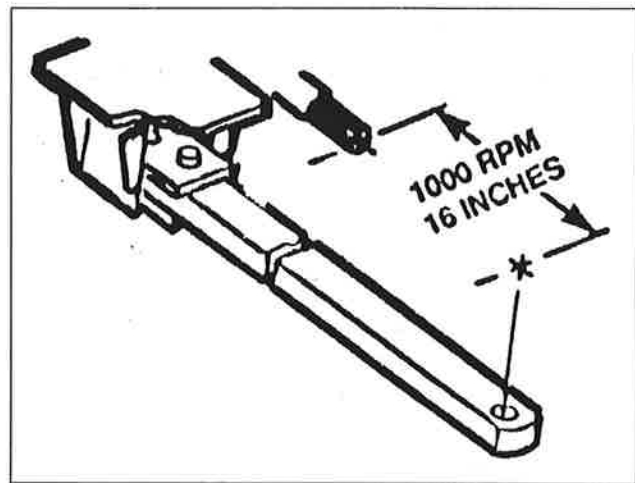

Fig. 2 DRAWBAR DIMENSION

5. Electrical:

A 12 volt 10 amp power source in the cab must be provided to operate the controllers. The controllers operate the solenoids and valves in the chemical circuit and the wing fold valves.

6. Tires:

The tractor can be equipped with tires of any size providing that they fit in the row spacing. Duals are recommended for stability on tractors over 100 horsepower.

4.6 CONTROLS

All functions on the sprayer are operated by the Controllers mounted in the tractor cab. It is recommended that all operators review this section of the manual to familiarize themselves with the location and function of all machine controls before starting. Refer to the Controller manual supplied with the machine to familiarize yourself with the calibration, operation and troubleshooting procedures. Either a manual or microprocessor controlled controller is available for the sprayer.

1. Spray Circuit Controller:

a. Automatic Controller:

A microprocessor based controller, manufactured by Raven, is available to set, monitor, adjust and display several spray circuit parameters for the operator. Review and follow the calibration procedure at the start of the season and when changing chemicals or nozzles. Familiarize yourself with each controller function and control before starting.

b. Manual Controller:

A manual controller, manufactured by Raven, that allows the operator to monitor and adjust the chemical circuit pressure and turn the wings ON and OFF is available for the operator. Read and follow the instructions in the manual before starting.

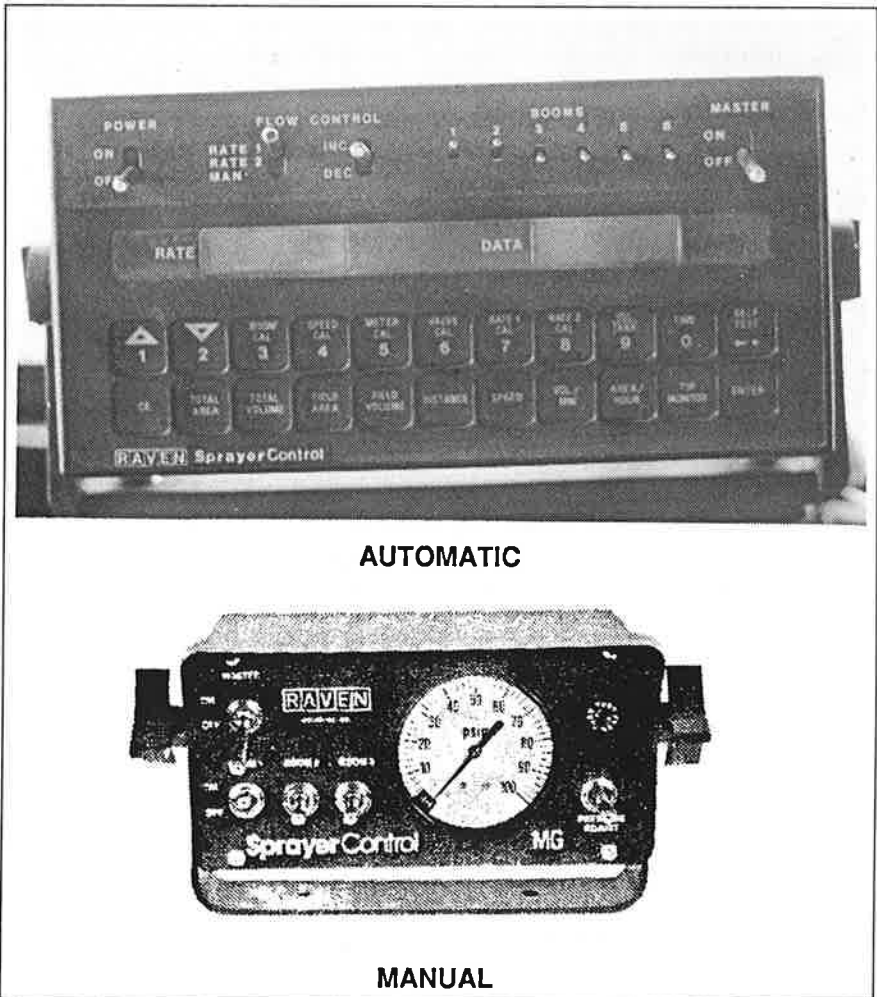

Fig. 3 SPRAY CIRCUIT CONTROLLER

2. **Second Wing Fold/Ext Controller:**

The spring-loaded toggle switches that operates the fold and extend function of the second wing are located in a box for mounting in the tractor cab. The hydraulic control lever to the wing must be engaged prior to operating.

a. Left Second Wing Ext/Fold:

Move the switch up to turn ON. This will fold the wing in or out depending on its position. Never turn switch ON unless main wing is full extended. Have second wing folded in and switch OFF before main wing folds over center.

b. Right Second Wing Ext/Fold:

Move the switch up to turn ON. This will fold the wing in or out depending on its position. Never turn switch ON unless main wing is full extended. Have second wing folded in and switch OFF before main wing folds over center.

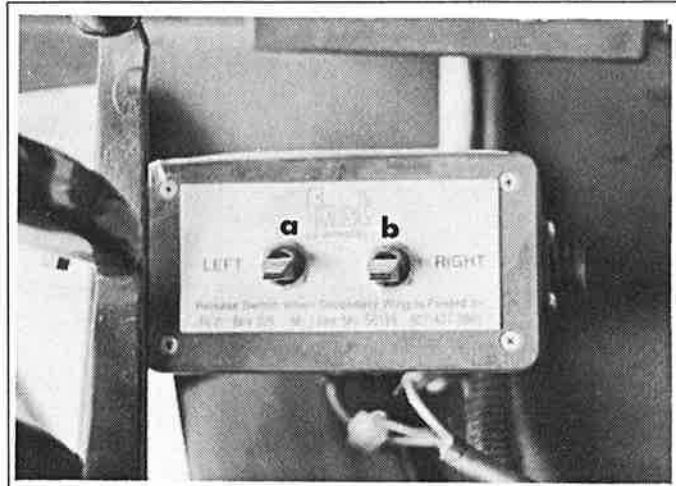

Fig. 4 SECOND WING FOLD/EXT CONTROLLER

IMPORTANT

Only move the second wing when the first wing is fully extended.



WARNING

Move the switch to the ON position to fold the secondary wing out or in only when the main wing is fully extended.

3. **Circuit Valves: (Optional)**
 The valves in the chemical circuit are used when filling or operating the sprayer. Refer to Section 4.11 to determine how the valves should be set.

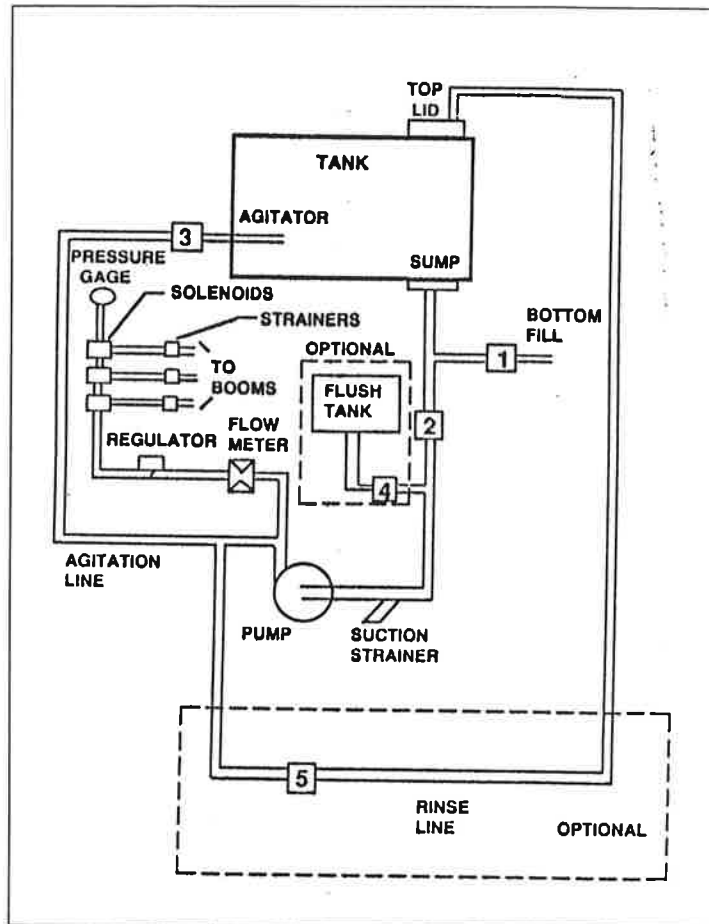

Fig. 5 CHEMICAL CIRCUIT

4. **Chemical Circuit Controls: (Optional)**
 These components are electrically operated by the Controller when calibrating or operating.
- Boom Solenoids
 - Flowmeter
 - Bypass or Agitation Valve
 - Regulator

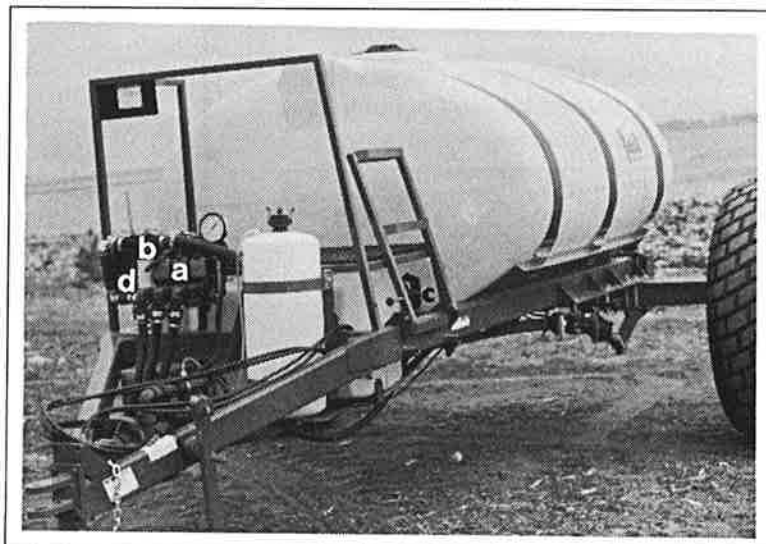

Fig. 6 CIRCUIT CONTROLS

5. **Foam Marker Control (Optional):**
This switch controls the function of the optional foam marker on the machine. Mount the toggle switch so that the left marker generates foam when the switch is moved to the left and the right functions when the switch is moved to the right. When the switch is centered, the marker is off.

6. **Tank Rinse Head (Optional):**
When a machine is equipped with the optional flush tank, it also comes with a tank rinse head that is plumbed through the top of tank. Open Valve 5 when rinsing or flushing the tank.

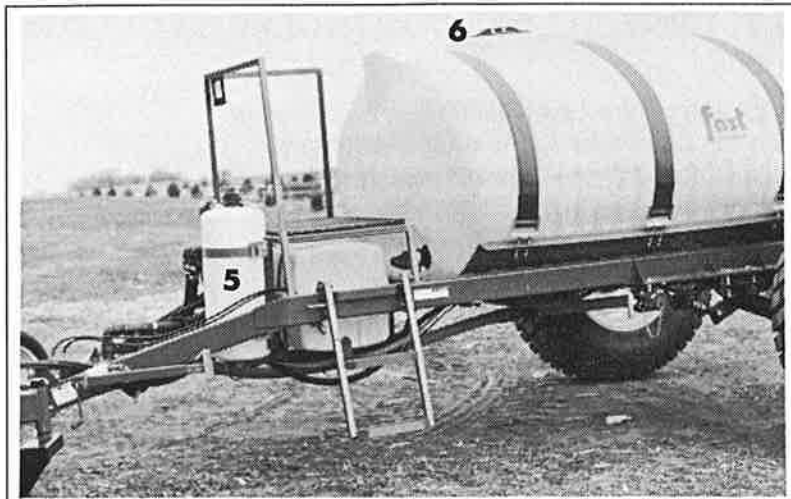

Fig. 7 OPTIONAL EQUIPMENT

7. **Hydraulic Controls:**
The hydraulic controls are located inside the tractor cab and convenient to the operator. Engage the circuit connected to the chemical circuit pump by moving the appropriate control lever. Place the lever in detent to provide a continuous flow of oil to the pump and the wing moving circuits.
8. **3 Point Hitch Control:**
The 3 point hitch control is located inside the tractor cab. Refer to the tractor manual for control position identification.

4.7 INSTALLING CONTROLLERS

A sprayer control box (Optional), a second wing function switch box and foam marker toggle switch (optional) are provided with each Sprayer and are mounted in the tractor cab.

1. Sprayer Control Box:

The control box is equipped with a "U" bracket secured by knobs on each end of the box. It provides a universal mounting system adaptable to any configuration.

Use the two holes provided in the bracket to mount to the box to a solid surface. Position the box to face the operator and tighten the knobs to hold the box in position.

Cut the power cable to the required length. Connect the white wire to ground and the red wire to a 12 volt potential. Refer to Controller Manual.



Fig. 8 CONTROLLER (TYPICAL)

IMPORTANT

Do not connect across a 24 volt system. It will damage internal electrical components.

2. Second Wing Function Switch Box:

Mount the box next to the sprayer controller to allow easy access. Sprayer box has magnets on back to fasten to any metal surface. Connect the black wire to ground and the red to a 12 volt potential.

Plug the wiring harness into the side of the box and extend it across the hitch to the machine. The harness is equipped with a connector terminal that plugs directly to the box in the cab.

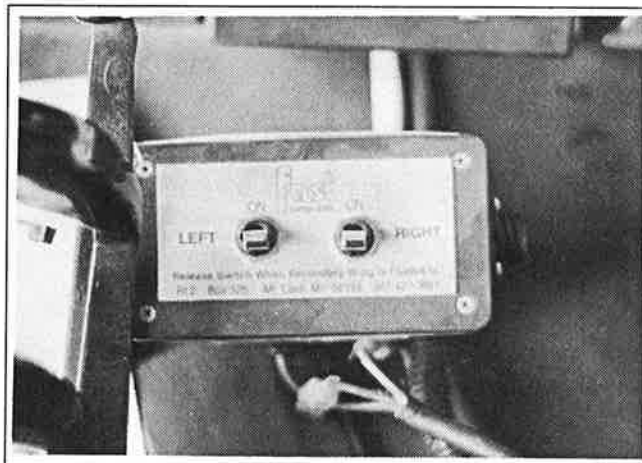

Fig. 9 SWITCH BOX

3. Foam marker Switch (Optional):

Mount the switch next to the second wing function switch box to allow easy access from the seat. Be sure to install the switch so that moving to the left activates the left marker. Connect the short wire to a 12V 10 amp power source. Secure with magnets.

4.8 ATTACHING/UNHOOKING TRACTOR

The machine can be used with the sprayer Boom attached in front of or on the back of the caddy if the caddy is equipped with an optional rear 3 point hitch.

4.8.1 Sprayer Ahead of Caddy

When attaching the machine, follow this procedure:

1. Make sure that all bystanders, especially small children, are clear of the working area.
2. Make sure there is enough room and clearance to safely back up to the sprayer.

IMPORTANT

It is recommended that the 3 Point Hitch be equipped with a Quick Hitch to make attaching easier.

3. Lower the 3 point hitch on the tractor until the Quick Hitch claws are below the mounting pins.
4. Retract the lower link retainers over the claws.
5. Back slowly up to the sprayer and align the lower link claws with the mounting pins.

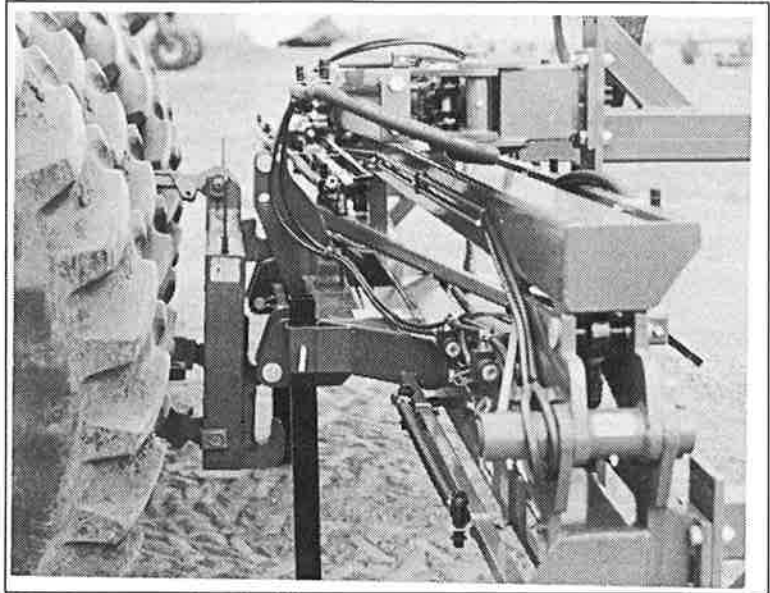

Fig. 10 QUICK HITCH

6. Slowly raise the 3 point hitch and be sure the mounting pins seat in the claws.
7. Raise the machine slightly off the ground.
8. Release the claw retainers to hold the pins in the claw.
9. If your tractor is not equipped with a Quick Hitch, it will be necessary to connect each arm to the machine.

IMPORTANT

Be sure the 3 point hitch is set in the non-sway configuration. Consult your tractor manual for details.



Fig. 11 ATTACHED

10. Attach the hydraulic system:
 - a. Use a clean rag or paper towel to clean the dirt from couplers on the hose ends and the tractor.
 - b. Connect the hoses to the tractor couplers. Be sure the couplers are securely seated.
 - c. Route the hoses to prevent binding and allow enough slack for raising and lowering.
 - d. Secure in position with clips, tape or ties.
11. Connect the wiring harnesses between tractor and the sprayer. Route the harnesses over the hitch to prevent snagging. Allow slack for raising and lowering the hitch.
12. Raise the machine off the ground.
13. Raise the stands and place in their stowed position or remove and store.
14. Set the top link of the 3 point hitch so the Quick Hitch is vertical when the frame is at its operating height.

15. Back up to the caddy.
16. Install the pin with its retainer.
Attach the safety chain around the sprayer frame to prevent unexpected separation.

17. Attach the hydraulic system:
 - a. Use a clean rag or paper towel to clean the dirt from couplers on the hose ends and the sprayer.
 - b. Connect the hoses to the couplers. Be sure the couplers are securely seated.
 - c. Route the hoses over the hitch to prevent binding and allow enough slack for raising and lowering.
 - d. Secure in position with clips, tape or ties.

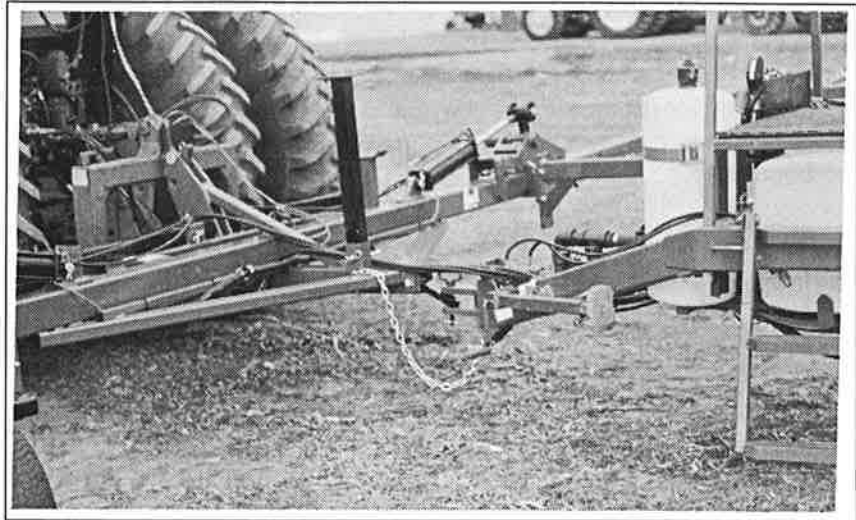

Fig. 12 ATTACHED

18. Raise the jack, rotate 90° and pin in its transport position.
19. Be sure the caddy frame is level. Adjust the hitch clevis as required to level the frame.
20. Reverse the above procedure when unhooking the sprayer.

4.8.2 CADDY AHEAD OF SPRAYER

1. Clear the area of bystanders, especially small children.
2. Make sure there is enough room to safely back to the machine.
3. Back up to the caddy.
4. Install the pin with its retainer. Attach the safety chain around the drawbar cage to prevent unexpected separation.
5. Attach the hydraulic system:
 - a. Use a clean rag or paper towel to clean the dirt from around the couplers on the hose ends and on the tractor.
 - b. Connect the hoses to the tractor couplers. Be sure the couplers are securely seated.
 - c. Route the hoses to prevent binding and allow enough slack for raising and lowering.
 - d. Secure in position with clips, tape or ties.
6. Connect the wiring harness between tractor and the caddy. Route the harness over the hitch to prevent snagging. Allow slack for turning.
7. Raise the jack. Remove and store to prevent contacting the tractor tire when turning.
8. Be sure the caddy frame is level. Adjust the hitch clevis as required to level the frame.
9. Back the caddy up to the sprayer and align the 3 point hitch arms with the mounting pins.

IMPORTANT

Be sure the caddy axle is mounted in its rearmost position to balance the weight of the sprayer.

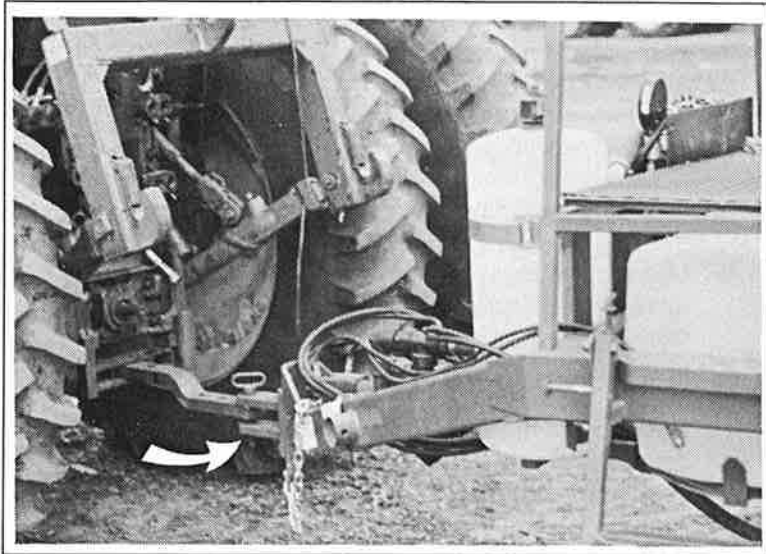

Fig. 13 DRAWBAR PIN

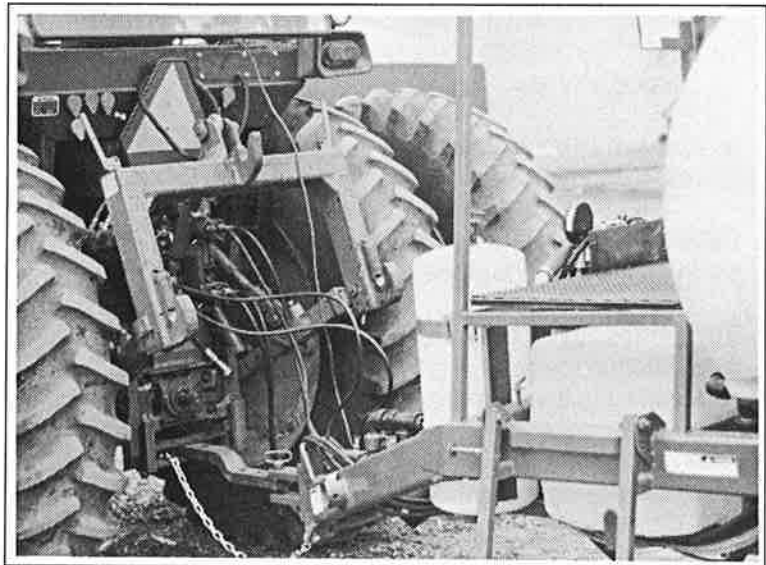

Fig. 14 ATTACHED

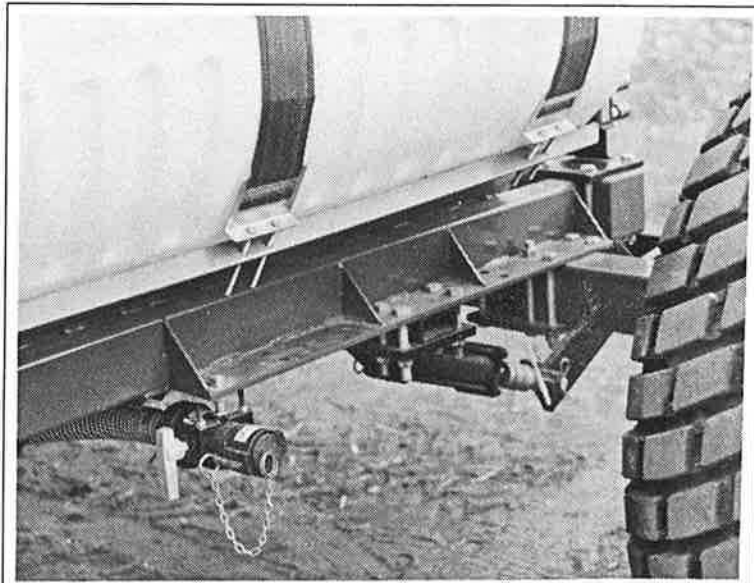

Fig. 15 AXLE MOUNT

10. Attach the sprayer to the 3 point hitch.
11. Be sure to use retainers on the mounting pins.

12. Attach the hydraulic system:

- a. Use a clean rag or paper towel to clean the dirt from around the couplers on the hose ends and on the caddy.
- b. Connect the hoses to the caddy couplers. Be sure the couplers are securely seated.
- c. Route the hoses to prevent binding and allow enough slack for raising and lowering.

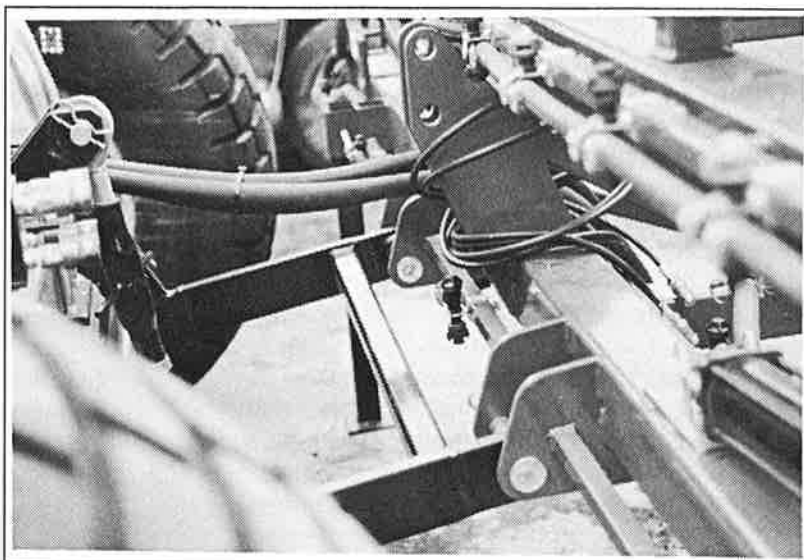

Fig. 16 ATTACHING

- d. Secure in position with clips, tape or ties.

13. Connect the chemical lines between the sprayer and the caddy. Be sure to push the cam-locks over-center.

14. Connect the wiring harness between caddy and the sprayer. Route the harness over the hitch to prevent snagging. Allow slack for raising and lowering the hitch.

15. Raise the hitch.

16. Remove and store the front 2 stands. Stow the rear stand on the frame.

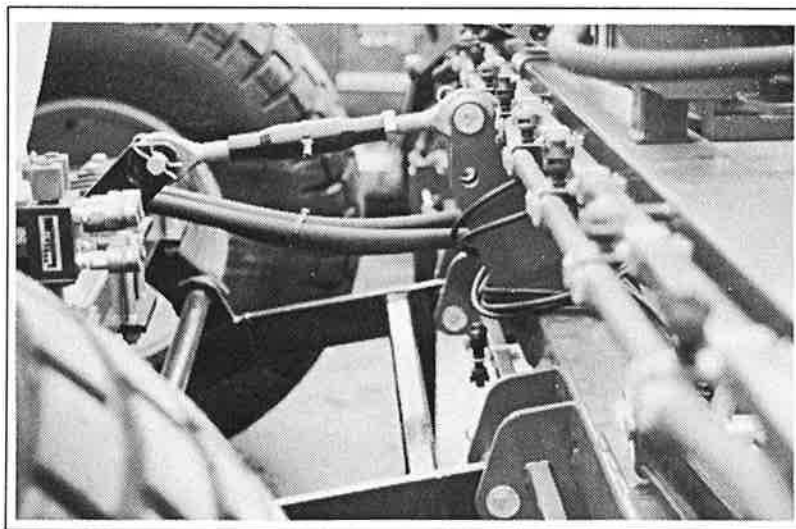

Fig. 17 ATTACHED

17. Reverse the above procedure when unhooking sprayer. Always support the sprayer on its stands and caddy hitch on its jack before unhooking.



4.9 SPRAYER CALIBRATION

A sprayer can only apply the proper amount of chemicals when each component in the system is functioning properly. Chemical action in the field is dependent upon the accurate application of minute amounts of the spray compound. A complete calibration of the machine is required at the start of each season or when changing chemicals during the spray season.

It is the responsibility of the customer to determine the amount of chemical that they want to apply for their particular application. Many factors affect how much chemical is applied such as: nozzle flow rate, chemical circuit pressure, pump speed, ground speed to name a few. In this section, instructions are given on how to accurately determine flow rates or application rates and how to change them. It is recommended that this procedure be followed carefully so you know exactly how much chemical is being applied.

4.9.1 ENGINE RPM

Although the exact value of the engine speed is not particularly important to sprayer function, it is recommended that it always be set at 2/3 or more throttle position. This will insure that there will be sufficient oil flow through the hydraulic system and sufficient power to maintain the ground speed.

Select the desired engine RPM and always perform the calibration and run in the field at the same setting.

4.9.2 CONTROLLER CALIBRATION

If your machine is equipped with the automatic controller, the controller itself must be set and calibrated for your specific machine. Refer to the Controller manual and follow its Calibration procedure. Use the same controller settings during sprayer component calibrations as used in the field.

4.9.3 NOZZLE CALIBRATION

Consult your dealer or the factory to determine the type of nozzles on your machine and their specific nominal flow rate. To determine or set the application rate, the flow rate of solution through the nozzles must be known. Operate the tractor at the same RPM and hydraulic setting as if running in the field. Start with the chemical circuit pressure at 15 psi. Increase or decrease pressure as required to obtain desired flow rate.

1. Remove all the nozzles from the sprayer.
2. Use clean water to wash each nozzle and clean the internal screen and check valve.
3. Reinstall the nozzles in the wings.

IMPORTANT

Never calibrate nozzles with active chemical in the tank. The solution can contaminate workers, the workplace and the environment.

4. Add clean water until the tank is 1/2 full.
5. Place a calibration cup under all the nozzles on each wing.

NOTE

Calibration cups are available from most agricultural offices or weed supervisors.

6. Run the tractor at the RPM selected in Section 4.9.1. Operate the chemical circuit pump at the desired pressure and measure the time that it takes to spray a quart or liter through each nozzle.

IMPORTANT

If the Controller cannot produce the required pressure in the chemical circuit, use the agitation valve to reset the system and try again.

Use Table 2 to determine flow rate for the nozzle.

Table 2 Nozzle Flow Rates

U.S. Gallons		Imperial Gallons		Metric	
Time Time/qt min:sec	Flow Rate fl. oz./min	Time Time/qt min:sec	Flow Rate fl. oz./min	Time Time/liter min:sec	Flow Rate m Liter/min
6:24	5.0	8:00	5.0	7:00	143
6:40	4.8	8:20	4.8	7:18	137
6:57	4.6	8:42	4.6	7:38	131
		8:53	4.5	7:45	129
7:07	4.5			7:56	126
7:16	4.4	9:05	4.4		
7:37	4.2	9:31	4.2	8:20	120
				8:46	114
8:00	4.0	10:00	4.0		
8:25	3.8	10:32	3.8	9:10	109
8:53	3.6			9:43	103
		11:07	3.6		
9:09	3.5	11:26	3.5	10:00	100
9:25	3.4	11:46	3.4	10:19	97
				10:59	91
10:00	3.2	12:30	3.2		
10:40	3.0			11:38	86
		13:20	3.0		
11:26	2.8	14:17	2.8	12:30	80
				13:31	74
12:18	2.6	15:23	2.6		
12:48	2.5			14:05	71
		16:00	2.5		
13:20	2.4	16:40	2.4	15:30	69
				15:52	63
14:32	2.2	18:11	2.2		
				16:33	57
16:00	2.0	20:00	2.0		

7. Replace all nozzles giving more than 10% above the nominal flow rate.
8. Reclean all nozzle components from nozzles 10% below the flow rate and then recheck.

NOTE

Measuring the flow rate for each nozzle will insure a consistent and uniform spray pattern across the entire machine.

4.9.4 MACHINE YARD CALIBRATION

After the nozzles have been calibrated, it is recommended that the entire system be calibrated. A yard run is the simplest method to determine total volume delivered. To calibrate in the yard, follow this procedure:

1. Fill the tank full of water (no chemicals).
2. Check that all filters are clean.
3. Set the chemical system and boom pressure to the desired value and run the tractor at the selected engine RPM.
4. Spray in a stationary position for a known period of time.
5. Refill the tank and measure accurately the amount of water used.
6. This will give the amount of spray used per time.

The total volume can be changed by increasing or decreasing the chemical system pressure. However if a change is made, it is recommended that the entire system be calibrated again to determine the new volumes.

4.9.5 GROUND SPEED CALIBRATION

For optimum spraying results, it is important to maintain a known constant speed to spray the required chemical over a given area. Because of wheel slippage, the operator cannot rely on the tractor speedometer reading to give the value of true ground speed. The unit must be timed over a known distance to determine true ground speed. To calibrate, follow this procedure:

1. Mark off distance of 100, 200 or 300 feet in the field to be sprayed (longer distances provide greater accuracy).
2. Place the tractor in the gear to give a speed between 6 and 8 mph (9.5 and 13 kph) and at the selected engine RPM.
3. With the tank 1/2 full of water, drive the tractor and sprayer through the measured distance.
4. Record the time required to travel the measured distance.
5. From Table 2 determine the actual tractor speed. You can shift gears to change speed but it is recommended that you go through the measured distances again to determine true ground speed.

IMPORTANT

Always operate at the engine RPM determined in Section 4.9.1.

Table 3 Ground Speed Calibration

Speed mph	Time In Seconds To Travel			Time To Travel 1/2 mile minutes:seconds
	100 ft.	200 ft.	300 ft.	
5.0	13.6	27.3	40.9	6:00
5.4	12.6	25.3	37.8	5:33
5.6	12.2	24.4	36.5	5:21
5.8	11.8	23.5	35.3	5:10
6.0	11.4	22.7	34.1	5:00
6.2	11.0	22.0	33.0	4:50
6.4	10.7	21.3	32.0	4:41
6.6	10.3	20.7	31.0	4:33
6.8	10.0	20.1	30.1	4:23
7.0	9.7	19.5	29.2	4:17
7.2	9.5	18.9	28.4	4:10
7.4	9.2	18.4	27.6	4:03
7.6	9.0	17.9	26.9	3:57
7.8	8.8	17.5	26.3	3:52
8.0	8.5	17.0	25.6	3:45
8.2	8.3	16.6	24.9	3:40
8.4	8.1	16.2	24.4	3:34
8.6	7.9	15.8	23.7	3:29
8.8	7.7	15.5	23.2	3:25
9.0	7.6	15.2	22.7	3:20
9.2	7.4	14.8	22.2	3:16
9.4	7.3	14.5	21.8	3:11
9.6	7.1	14.2	21.3	3:08
10.0	6.8	13.6	20.5	3:00

Speed km/h	Time In Seconds To Travel			Time To Travel 1 kilometer minutes:seconds
	30.5 m	61.0 m	91.4 m	
7.0	15.9	31.7	47.6	8:44
7.5	14.8	29.5	43.2	8:08
8.0	13.6	27.3	40.9	7:30
8.5	12.9	25.9	38.7	7:05
9.0	12.2	24.4	36.5	6:41
9.5	11.6	23.2	34.7	6:21
10.0	11.0	22.0	33.0	6:02
10.5	10.5	21.0	31.5	5:46
11.0	10.0	20.1	30.1	5:29
11.5	9.6	19.2	29.2	5:21
12.0	9.1	18.2	27.3	5:00
12.5	8.7	17.5	26.3	4:49
13.0	8.4	16.8	25.3	4:38
13.5	8.1	16.2	24.4	4:27
14.0	7.8	15.7	23.5	4:19
14.5	7.6	15.2	22.7	4:10
15.0	7.3	14.7	22.0	4:02
15.5	7.1	14.0	21.3	3:55
16.0	6.9	13.8	20.7	3:47

4.9.6 AREA COVERED

To determine application rates, it is necessary to know the area covered by the sprayer during one pass. Table 4 gives the area for the five widths:

Table 4 Actual Sprayer Coverage

Sprayer Width	Acres		Hectares	
	1/2 mile	1/4 mile	1/2 km	1/4 km
45'	2.72	1.87	1.09	.55
60'	3.64	1.82	1.45	0.73
72'	4.36	2.18	1.75	0.87
80'	4.85	2.42	1.94	0.97
90'	5.45	2.73	2.18	1.09

4.9.7 FIELD CALIBRATION

To verify the application rates in the field, follow this procedure:

1. Fill the tank to the neck with water and mark the level of water.
2. Check that all screens are clean.
3. Set the chemical system pressure to the desired value and run the tractor at the selected engine RPM in the selected gear.
4. Drive through the measured distance while spraying.
5. Refill the tank to the same mark and measure the amount required.
6. Divide the amount of liquid sprayed by the area covered to determine the application rate.

$$\text{Appl. Rate} = \frac{\text{Volume sprayed}}{\text{Area covered}} = \frac{\text{gals (liters)}}{\text{acre (hectare)}}$$

Table 5 Conversions

1 km.....	0.62 mile
1 ha	2.5 acres
1 g	0.035 oz.
1 kg.....	2.2 lbs.
1 g/ha	0.014 oz/acre
1 kg/ha	0.88 lb/acre
1 ml.....	0.035 fl. oz.
1L.....	0.264 gal (US)
1L.....	0.22 gal (Imp.)
1L/s	15.85 gpm (US)
1L/s	13.20 gpm (Imp.)
1 kPa	0.145 psi
1 mm	0.04 in.
1 m	3.28 ft.
1 L/ha.....	0.106 gal (US)/acre
1 L/ha.....	0.088 gal (Imp.)/acre

4.10 FIELD OPERATION



OPERATING SAFETY

1. Read and understand the Operator's Manual and all safety signs before using.
2. Place all controls in neutral, stop tractor engine, turn monitor off, set park brake, remove ignition key, wait for nozzles to stop spraying before servicing, adjusting, repairing or unplugging.
3. Before spraying a field, be familiar with all potential hazards: trees, rocks, ditches, gullies, etc. Plan the spraying route to avoid hazards. Remember you are driving a wide machine. **USE CAUTION WHEN CORNERING.**
4. Keep hands, feet, hair and clothing away from all moving and/or rotating parts.
5. Do not allow riders on the sprayer or tractor during operation or transporting.
6. Stay away from overhead obstructions and power lines when extending or folding wings. Electrocution can occur without direct contact.
7. Caddy hitch can upend. Do not stand over hitch when unhooking. Support hitch and sprayer on stands before removing pin.
8. Attach securely to towing. Install retainers through pins and attach safety chain.
9. Stay away from wing pinch points when folding or extending wings. Keep others away.
10. Clear the area of all bystanders, especially children, before starting or filling with water or chemical.
11. Read chemical manufacturers warnings, instructions and procedures before starting and follow them exactly.
12. Do not breathe, touch or ingest chemicals. Always wear protective clothing and follow safe handling procedures.
13. Spray only when potential for chemical drift is at a minimum. Even small amounts can affect neighboring crops or sensitive plants and people.
14. Dispose of chemical containers by triple rinsing them into the sprayer tank or thoroughly rinsing, crushing and delivering to regional disposal site.
15. In case of poisoning, get immediate medical attention.
16. Only rinse sprayer while still in the field. Spray the rinse thinly over the field already sprayed. Never contaminate the farmyard or drainage systems with sprayer rinse.
17. Do not eat in the field when spraying.
18. Before applying pressure to the hydraulic system, make sure all components are tight and that steel lines, hoses and couplings are in good condition.
19. Before applying pressure to chemical system make sure that all connections are tight and that all hoses and fittings are in good condition.
20. Review safety instructions annually.

Follow this procedure when using the sprayer:

1. Attach sprayer to the machine (see Section 4.8).
2. Review and follow the pre-operation checklist (see Section 4.4).
3. Review the location and function of all controls (see Section 4.6).
4. Read and follow chemical manufacturers' instructions.
5. Calibrate the sprayer so you know exactly how much chemical is being applied (see Section 4.9). The application of excess chemicals, even in small amounts, can have detrimental affects. Recalibration at the start of the season or when changing chemicals is a must.
6. Transport the sprayer to the working area (See Section 4.12).
7. Convert into field position (see Section 4.11).

8. After arriving at the field, fill the sprayer.
9. Extend the hose from the supply vehicle or pump to the sprayer. Water can be added through the top lid or bottom fill fitting.

IMPORTANT

It is recommended that the water supply system be equipped with a pump for transferring water. The sprayer chemical circuit pump can be used for filling, if it is required.

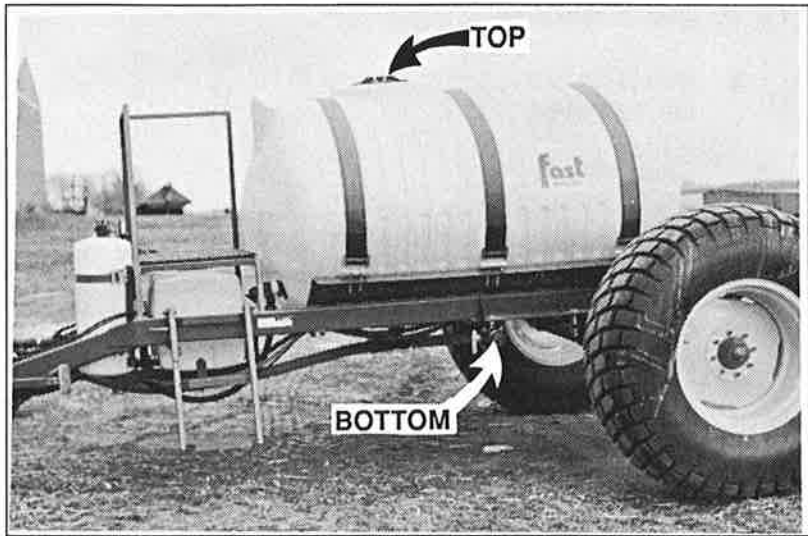

Fig. 18 FILLING

10. To top fill:

- a. Place the water hose into the top lid, start the pump on the supply vehicle and run until the tank is full. Stop the pump, remove hose and close the lid.

IMPORTANT

Be sure the water is clean. Clean water is necessary to prevent nozzle screen and check valve plugging.

- b. The chemical can be added through the top lid. Be sure to triple rinse the container when empty. Valve 1 closed. Valve 2 open. Valve 3 partial.
- c. Do not run pump until the tank is 1/4 full of water. Water is required in the pump to cool the seals. A head of water is required to keep the pump primed. Be sure the booms are turned off.
- d. Run in the circulate mode for at least 5 minutes to thoroughly mix the solution before starting.

IMPORTANT

If pump is not primed, stop immediately and bleed the air out of the pump.

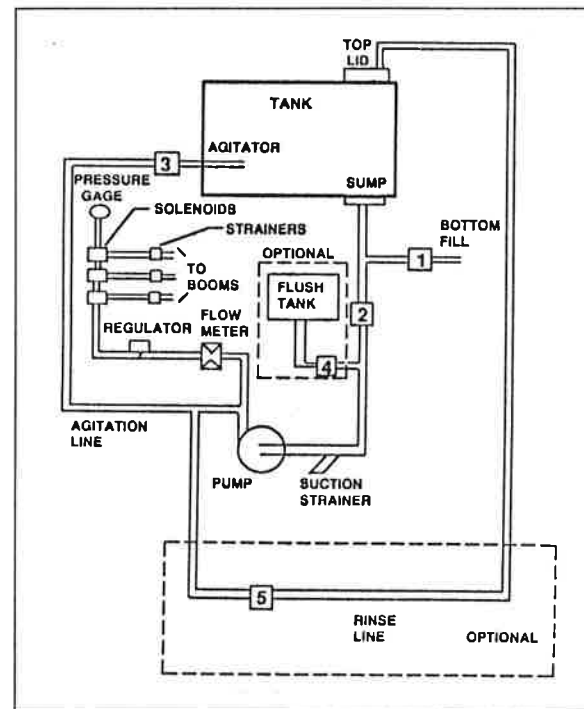

Fig. 19 TOP FILL



DANGER

1. Wear rubber gloves, eye protection and protective clothing whenever handling chemicals.
2. Do not breathe vapor or ingest chemicals and avoid contact with exposed skin.
3. Follow chemical manufacturers' instructions.

11. To bottom fill:

- a. Before removing cap on bottom fill fitting, set the valves.

Close Valve 2.

- b. Remove cover on bottom fill fitting, attach hose and secure with cam-locks.
- c. Open Valve 1 to allow the flow of water into the tank.
- d. Start the supply source pump, open the valve at the supply vehicle and fill the sprayer.
- e. Open Valve 2 and start the sprayer pump to draw the water through the system.

IMPORTANT

Be sure the water is clean. Clean water is necessary to prevent nozzle screen and check valve plugging.

IMPORTANT

Do not start the sprayer pump until the water from the supply vehicle has started to flow. Water is necessary to cool and lubricate the pump seals. Without water, the seals will fail in a few minutes.

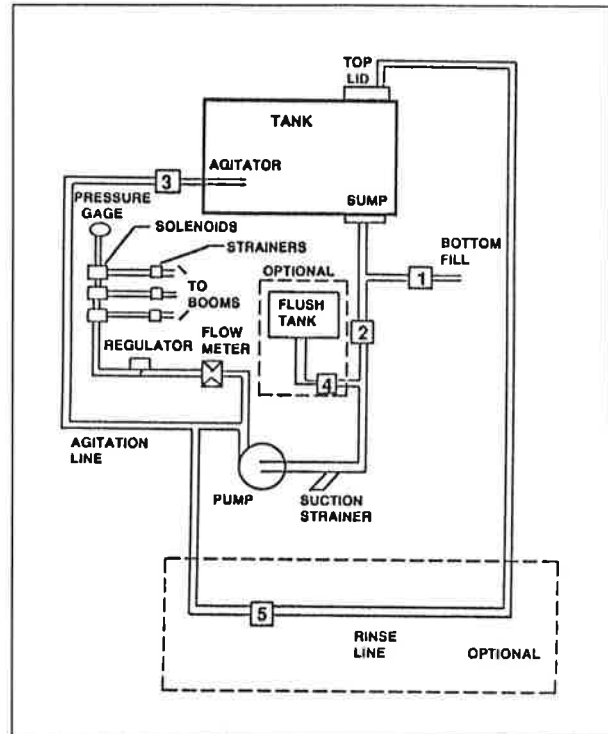

Fig. 20 ADDING WATER

f. While the tank is filling, add the chemical.

i. Start the machine pump for agitation.

ii. Add the chemical through the top lid or the eductor tank on the water supply vehicle.

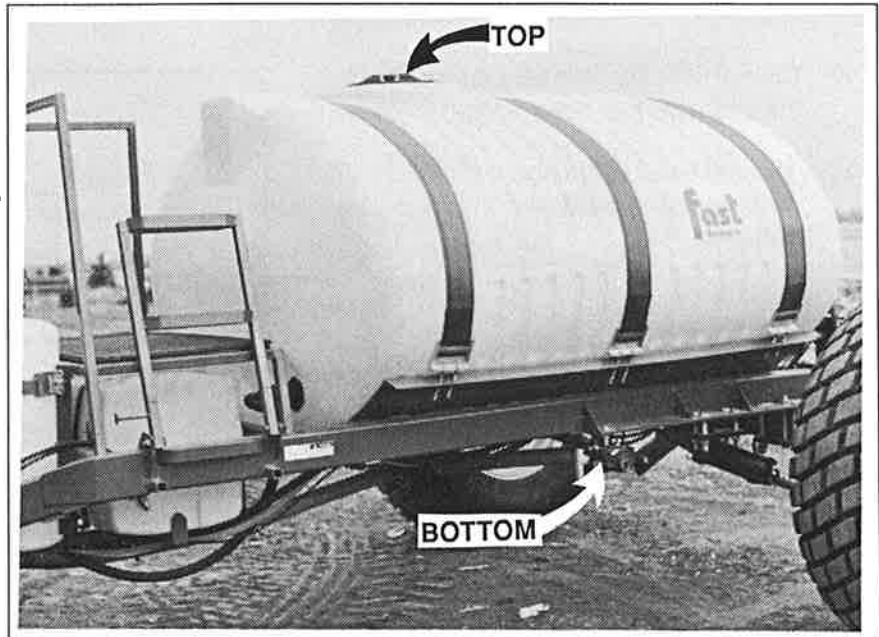

Fig. 21 ADDING CHEMICALS



DANGER

1. Wear rubber gloves, eye protection and protective clothing whenever handling chemicals.
2. Do not breathe vapor or ingest chemicals and avoid contact with exposed skin.
3. Follow chemical manufacturers' instructions.

IMPORTANT

The sprayer pump must be running to circulate the solution in the system and provide agitation.

iii. Triple rinse each chemical container when empty.

- iv. Repeat with the next container until all the chemical has been added.
- v. Discard used containers at your nearest container disposal site.

WARNING

1. Do not burn chemical containers as toxic fumes could contaminate the area.
2. Do not discard chemical containers in ditches.
3. Do not place containers in landfills.
4. Dispose at nearest container disposal site.

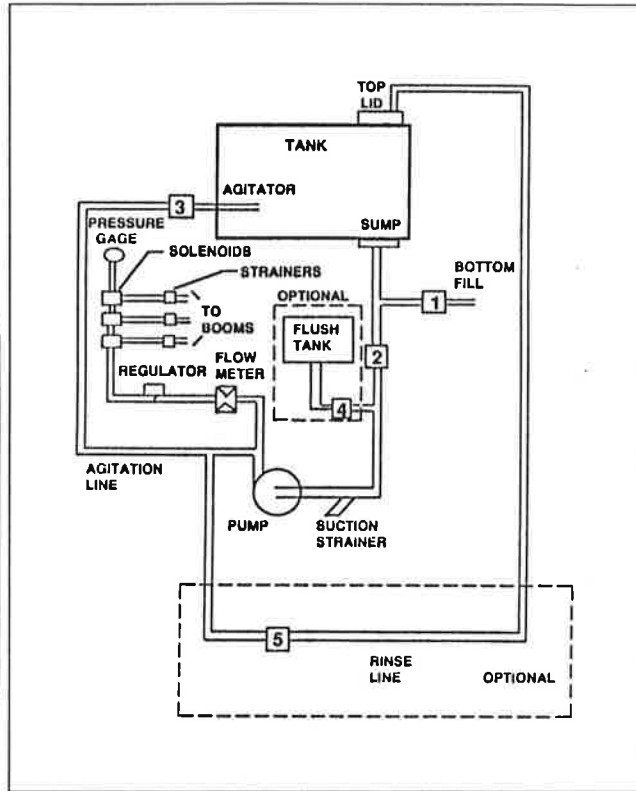

Fig. 22 CHEMICAL CIRCUIT

- g. When the tank is full, close the Valve at the supply source and stop the pump.
 - h. Before disconnecting the water line, close Valve 1 at the bottom fill fitting.
 - i. Disconnect the water hose and secure the cap.
 - j. Run the pump to allow the solution to circulate. Mix for 2 minutes before starting to spray.
 - k. Move the supply vehicle out of the way.
12. Fill the Flush tank and clean water tank (if so equipped) as required.
 13. Fill the foam marker tank at the start of each working day and whenever it is needed.

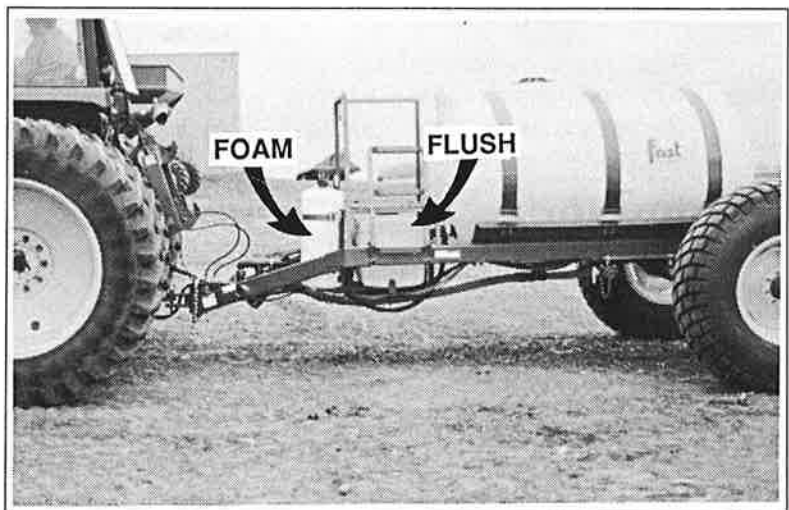

Fig. 23 AUXILIARY TANKS

14. Although well water is recommended, surface water can be used if it is thoroughly filtered. Be sure to keep the filters clean when using this method.
15. If using wettable powders, remove the top tank lid and slowly add the powder. Be sure the tank is at least 1/2 full of water and the pump is running.

If the powder is not added slowly, clumps of powder will be drawn into the suction line and plug the screen in the filter.

IMPORTANT

It is recommended that the wettable powder be pre-mixed in hot water before adding to the sprayer. This prevents clumps from plugging the filters. Triple rinse the mixing container when it is empty.

16. If foaming occurs, add an anti-foaming additive to the tank.
17. **Nozzle Height:**
The nozzle is adjustable from 15 to 36 inches (385 to 920 mm) and set by the position of the 3 point hitch. Set the height of the wing wheels to maintain a level wing frame. Set the height so the spray pattern from the nozzles overlap a couple of inches above the crop canopy or plants.

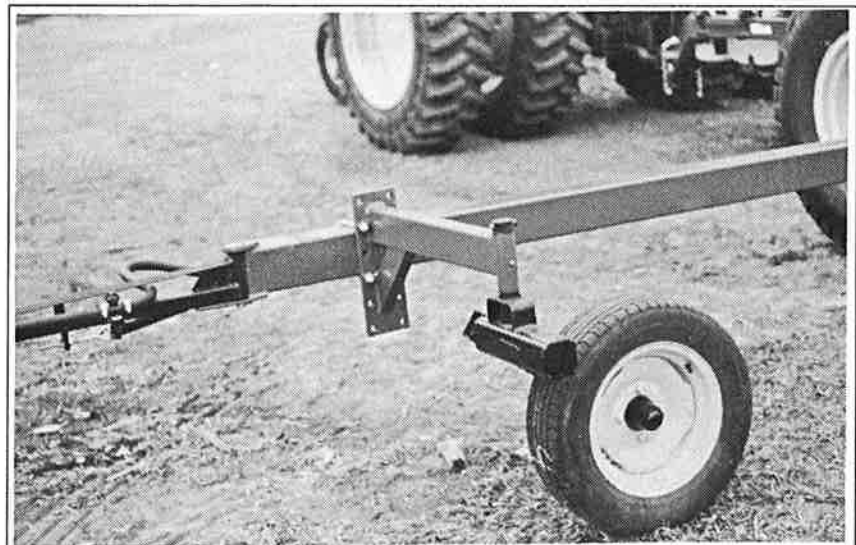

SPRAYER

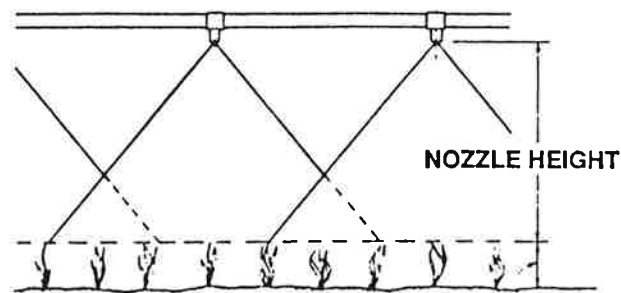

AVERAGE TARGET HEIGHT

DIAGRAM

Fig. 24 NOZZLE HEIGHT

18. Travel Speed:

Crop and plant type will determine the travel speed for spraying.

a. Cereal crops - broadcast planting:

A travel speed of 6 to 8 mph (9.7 to 13 Km/hr) is recommended for most operating conditions.

b. Row Crops:

A travel speed of 8 mph (12.9 Km/hr) is recommended in row crops. For crops that have a dense foliage canopy, this slower speed gives more time for the spray to open the plant canopy and allow the chemical to get inside and coat the underside of the leaves.

19. For broadcast spraying,

It is recommended that the operator make one pass around a field to start and then spray back and forth to obtain the best results. Using a marker system helps to prevent skips or overlap.

If your field has headlands, be sure to allow sufficient space for turning.

20. For row crop spraying, start at one edge of the field and go back and forth until the field is completed.

21. Be sure the sprayer is calibrated, the nozzle height and pressure are known and the tractor gear and RPM are determined before starting to spray (see Section 4.9).

22. Proceed down the field at a constant speed. Use the selected gear, engine RPM and ground speed determined during the calibration of the machine application rate.

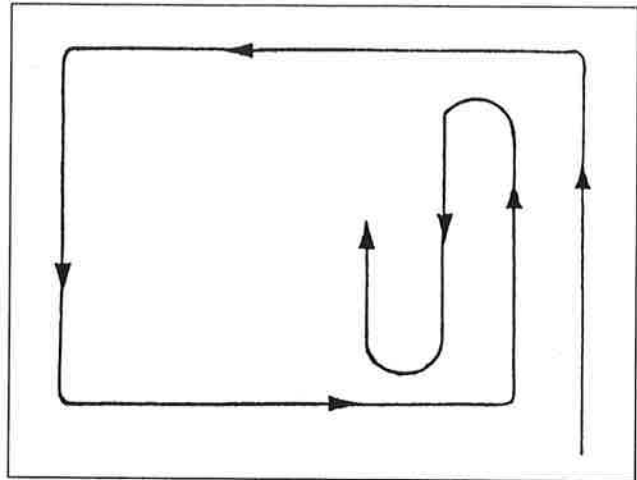

Fig. 25 TRAVEL PATTERN (BROADCAST)

23. Place the Master Boom switch in the OFF position and the Left and Right Boom switches in the ON position.
24. Turn the booms ON with the Boom Master switch as the nozzles pass over the edge of the already sprayed headland and come to the area to be sprayed. Use the individual boom switches as appropriate when finishing a field.
25. When completing a pass and approaching the sprayed headland, maintain the tractor RPM and ground speed until the nozzles have covered all the plants. This will insure a consistent application rate at the ends of the field.
26. Swing wide when making turns. Do not back the outer wing wheel up when turning as this will cause overlap when starting to spray again.
27. When turning or moving, one or both of the main wings can be raised a little to clear roadways or low obstructions.



Fig. 26 CONTROL BOX (TYPICAL)

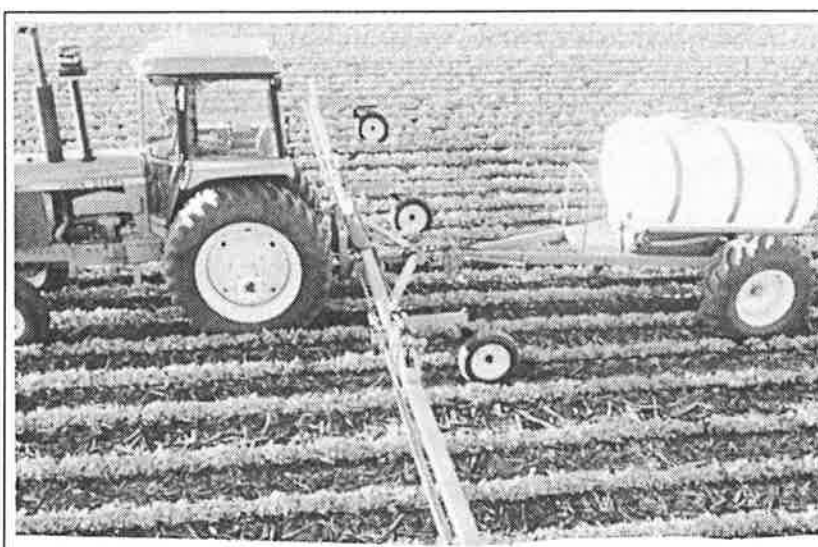

Fig. 27 SPRAYING

28. The outer end of the second wing is equipped with a spring loaded break - away to allow the wing to fold preventing damage. It swings back into position when the obstruction is by.

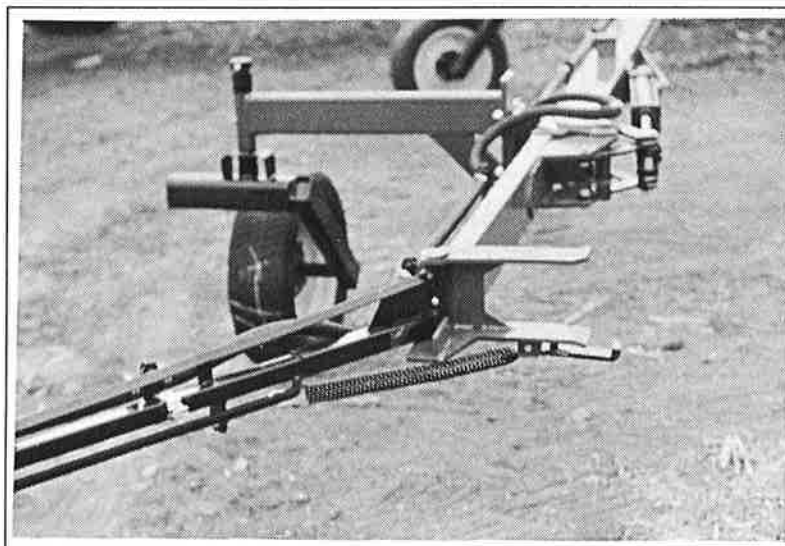

Fig. 28 BREAKAWAY

29. Flush Tank (Optional):

The machine can be equipped with a 50 gallon flush tank on the front of the caddy. It should be used at the end of each working day to flush out the pump and booms to prevent corrosion. Or use it to flush out the system prior to performing any maintenance work on the machine. Refill the tank again with clean water when refilling the main tank.

To flush the tank, close the valve out of the main tank and open the valve to the flush tank. Reverse this procedure prior to starting to operate again.

30. Mix only the quantity of spray required for the job. Excess chemicals are difficult to store and dispose of. Do not dispose of them in the farmyard or your drainage system. They will contaminate these areas.
31. Store chemicals only in their original containers under lock and key to prevent children or animals from touching them.
32. Be very careful to wear the proper protective gear such as rubber gloves and goggles to protect yourself. Thoroughly wash all protective gear with a good detergent after use to remove all chemicals.

33. Never allow chemicals or solutions to touch the skin. Some can be absorbed through the skin. Should such a contact occur, flush the affected area immediately with clear water. Wash the area thoroughly with detergent to remove any residue.

34. When spraying is done, the machine should always be rinsed. Follow this procedure:

- a. Add 25 to 50 gallons of water to the tank.
- b. Run the pump, wash circuit and agitator for 5 minutes to circulate and rinse the inside of the tank.
- c. Spray the rinse thinly over the previously sprayed field.



WARNING

Do not dispose of it in the farmyard or in drainage ditches.

35. When spraying is finished for the season or when switching chemicals, wash the sprayer using the method described in the Maintenance Section.

4.11 TRANSPORT/FIELD CONVERSION

The sprayer is designed to easily convert from transport to field or field to transport.

When converting from transport to field, follow this procedure:

1. Clear the area of bystanders, especially children, before starting.
2. Convert only on level ground in an area that is free of overhead obstructions and power lines. Electrocutation can occur without direct contact.
3. Be sure there is sufficient room to swing the wings through their movement range.
4. With the engine running at half throttle or more, extend the right inner wing until it is fully extended on the ground.

IMPORTANT

Extend the inner wing cylinder completely so the linkage will allow the wing to follow the ground contour.

5. Fully extend the right second wing.
6. Fully extend the left first wing.
7. Fully extend the left second wing. Do not extend second wing until first wing is extended.



Fig. 29 RIGHT FIRST WING EXTEND

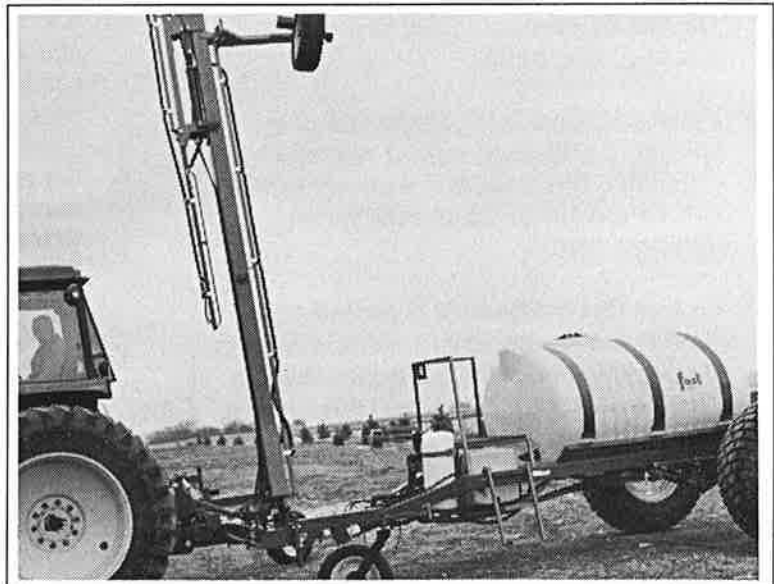

Fig. 30 LEFT FIRST WING EXTEND

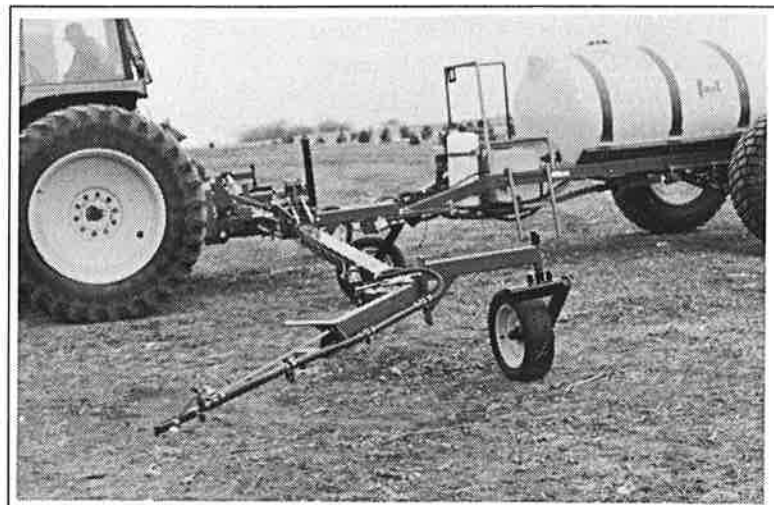

Fig. 31 LEFT SECOND WING EXTEND

8. Reverse the above procedure when converting from field to transport.

4.12 TRANSPORT



TRANSPORT SAFETY

1. Read and understand ALL the information in the Operator's Manual regarding procedures and SAFETY when operating the Sprayer in the field and/or on the road.
2. Check with local authorities regarding sprayer transport on public roads. Obey all applicable laws and regulations.
3. Always travel at a safe speed. Use caution when making corners or meeting traffic.
4. Make sure the SMV (Slow Moving Vehicle) emblem and all the lights and reflectors that are required by the local highway and transport authorities are in place, are clean and can be seen clearly by all overtaking and oncoming traffic.
5. Install additional lights on the rear of the sprayer to safeguard against rear end collisions. Daybreak and dusk are particularly dangerous and pilot vehicles are recommended.
6. Be sure that the Sprayer is hitched positively to the towing vehicle and a retainer is used through each mounting pin. Always attach a safety chain between the caddy and the towing machine.
7. Be sure wing frames are over center and resting against their supports before transporting.
8. Keep to the right and yield the right-of-way to allow faster traffic to pass. Drive on the road shoulder, if permitted by law.
9. Do not exceed 20 mph (32 km/h). Reduce speed on rough roads and surfaces.
10. Always use hazard warning flashers on tractor when transporting unless prohibited by law.
11. Never transport with the tank filled with water or chemical.

Fast Distributing sprayers are designed to be easily and conveniently moved from field to field. When transporting, follow this procedure:

1. Be sure all bystanders are clear of the machine.
2. Be sure that the Sprayer is hitched positively to the towing vehicle. Always attach the safety chain between the machine and the tractor and a retainer on the drawbar pin and mounting pins.
3. Keep to the right and yield the right-of-way to allow faster traffic to pass. Drive on the road shoulder, if permitted by law.
4. Make sure the SMV (Slow Moving Vehicle) emblem and all the lights and reflectors that are required by the local highway and transport authorities are in place, are clean and can be seen clearly by all overtaking and oncoming traffic.
5. It is not recommended that the machine be transported faster than 20 mph (32 km/hr). Table 6 gives the acceptable transport speed as the ratio of tractor weight to sprayer weight.

Table 6 Travel Speed vs Weight Ratio

<u>Road Speed</u>	<u>Weight of fully equipped or loaded implement(s) relative to weight of towing machine</u>
Up to 32 km/h (20 mph)	1 to 1, or less
Up to 16 km/h (10 mph)	2 to 1, or less
Do not tow	More than 2 to 1

6. Do not allow riders on the machine or tractor.
7. During periods of limited visibility, use pilot vehicles or add extra lights to the sprayer.
8. Always use hazard flashers on the tractor when transporting unless prohibited by law.

4.13 STORAGE



STORAGE SAFETY

1. Store unit in an area away from human activity.
2. Do not permit children to play on or around the stored sprayer.
3. Install frame legs and secure with pins before unhooking from tractor.

4.13.1 PLACING IN STORAGE

At the end of the spray season, the machine should be thoroughly inspected and prepared for storage. Repair or replace any worn or damaged components to prevent any unnecessary down time at the beginning of the next season. Follow this procedure:

1. Thoroughly wash the machine using a hose or a pressure washer to remove all dirt, mud, debris or residue.
2. Thoroughly wash the inside of the tank and spray system to remove all chemical residue using the method described in the Maintenance Section.
3. In climates that encounter freezing temperatures during the storage period, the following preparation should be done:
 - a. Add 10 gallons (40 liters) of a 50:50 mixture of antifreeze and water or windshield washer fluid to the tank.
 - b. Run unit for 5 minutes to circulate solution to all parts of the circuit.
 - c. While circulating the fluid, open and close all the valves in the chemical circuit several times to flush all the water from the system.
 - e. Flush the solution out the booms.
 - f. Open all disconnects and drain hoses, pumps, filters and solenoids.
4. Lubricate all grease points. Make sure all grease cavities have been filled with grease to remove any water residue from the washing.
5. Inspect all the hydraulic hoses, couplers and fittings. Tighten any loose fittings. Replace any hose that is badly cut, nicked, abraded or is separating from the crimped end of a fitting.

6. Inspect all the spray hoses and fittings. Tighten any loose fittings. Replace any hose that is badly cut, nicked, abraded or is separating from a fitting.
7. Touch up all paint nicks and scratches to prevent rusting.
8. Move the machine to its storage position.
9. Select an area that is dry, level and free of debris.
10. Place planks under the jack for added support if required.
11. Unhook the machine from the tractor (Refer to Section 4.8). Caddy hitch can upend. Support machine on stands and jack before unhooking.



12. Remove the control boxes from the cab and store inside.
13. The tank is made out of polyethylene. Do not use to store petroleum products. They will soften the plastic and absorb the product.
14. It is best to store the sprayer in a shaded area

4.13.2 REMOVING FROM STORAGE

When removing from storage and preparing to use, follow this procedure:

1. Clear the area of bystanders, especially small children, and remove foreign objects from the machine and the working area.
2. Remove the tarpaulin if it was used for storage.
3. Attach the tractor to the sprayer by following the procedure in Section 4.8.
4. Check
 - a. Tank for cracks.
 - b. Tank hold down hardware.
 - c. All hardware. Tighten as required.
 - d. Tire pressure.
 - e. All sprayer and hydraulic lines, fittings and connections. Tighten as required.
5. Lubricate all grease fittings.
6. Replace any defective parts.
7. Fill the tank with 20 gallons (75 liters) of clean water and run for 5 minutes. Open and close all valves several times. Flush water through the booms.
8. Repeat step 7.
9. Calibrate the pump, nozzles and sprayer before using.
10. Go through the pre-operation checklist (Section 4.4) before using.

5 SERVICE AND MAINTENANCE



MAINTENANCE SAFETY

1. Review the Operator's Manual and all safety items before working with, maintaining or operating the Sprayer.
2. Place all controls in neutral, stop the tractor engine, turn monitor off, set park brake, remove ignition key, wait for nozzles to stop spraying before servicing, adjusting, repairing or unplugging.
3. Follow good shop practices:
 - Keep service area clean and dry.
 - Be sure electrical outlets and tools are properly grounded.
 - Use adequate light for the job at hand.
4. Before applying pressure to a hydraulic system, make sure all components are tight and that steel lines, hoses and couplings are in good condition.
5. Before applying pressure to chemical system make sure that all connections are tight and that all hoses and fittings are in good condition.
6. Relieve pressure from hydraulic circuit before servicing or disconnecting from tractor.
7. Keep hands, feet, clothing and hair away from all moving and/or rotating parts.
8. Clear the area of bystanders, especially children, when carrying out any maintenance and repairs or making any adjustments or filling.
9. Place stands or blocks under the frame before working beneath the machine.
10. Wear safety goggles, neoprene gloves and protective clothing when working on the sprayer filled with active chemical.
11. Wash machine to remove all chemical residue before working on unit. Wear appropriate protective gear at all times.
12. Protect yourself from chemical contamination.

5.1 SERVICE

5.1.1 FLUIDS AND LUBRICANTS

1. Grease
Use an SAE multi-purpose high temperature grease with extreme pressure (EP) performance. Also acceptable is an SAE multi-purpose lithium base grease.
2. Storing Lubricants
Your machine can operate at top efficiency only if clean lubricants are used. Use clean containers to handle all lubricants. Store them in an area protected from dust, dirt, moisture and other contaminants.

5.1.2 GREASING

Refer to Section 5.1.1 for recommended grease. Use the Maintenance Checklist provide to keep a record of all scheduled maintenance.

1. Use only a hand-held grease gun for all greasing.
2. Wipe grease fitting with a clean cloth before greasing, to avoid injecting dirt and grit.
3. Replace and repair broken fittings immediately.
4. If a fitting will not take grease, remove and clean thoroughly. Also clean lubricant passageway. Replace fitting if necessary.

5.1.3 SERVICING INTERVALS

8 Hours or Daily

1. Grease first wing hinge (2 locations each wing).

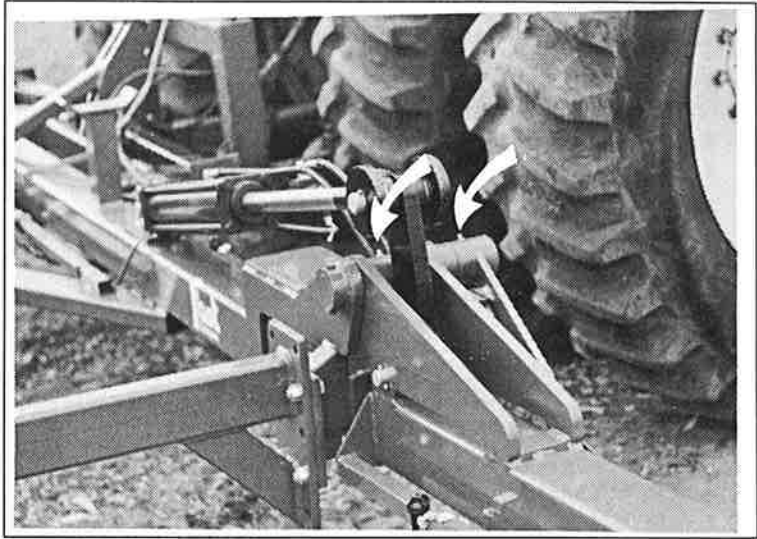

Fig. 32 FIRST WING HINGE

2. Grease second wing hinge (1 location each wing).

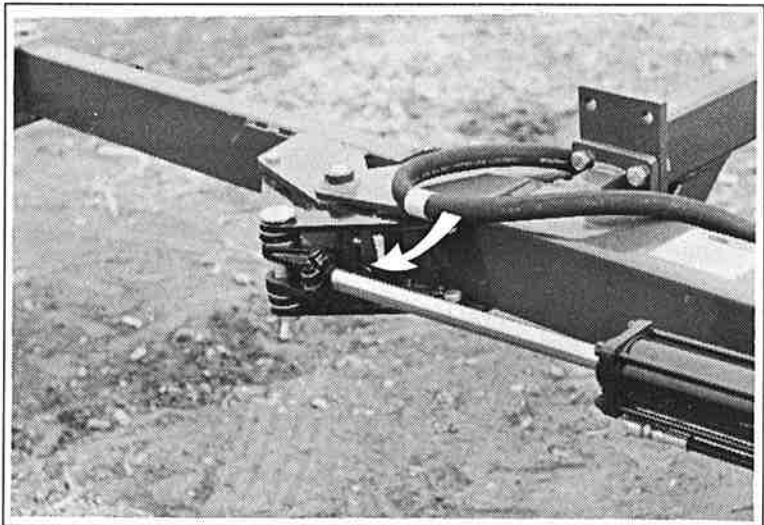

Fig. 33 SECOND WING HINGE

3. Grease wing wheel caster shaft (1 location each wheel).



Fig. 34 WING WHEEL CASTER SHAFT

4. Grease outer wing break - away hinge (1 location each wing).

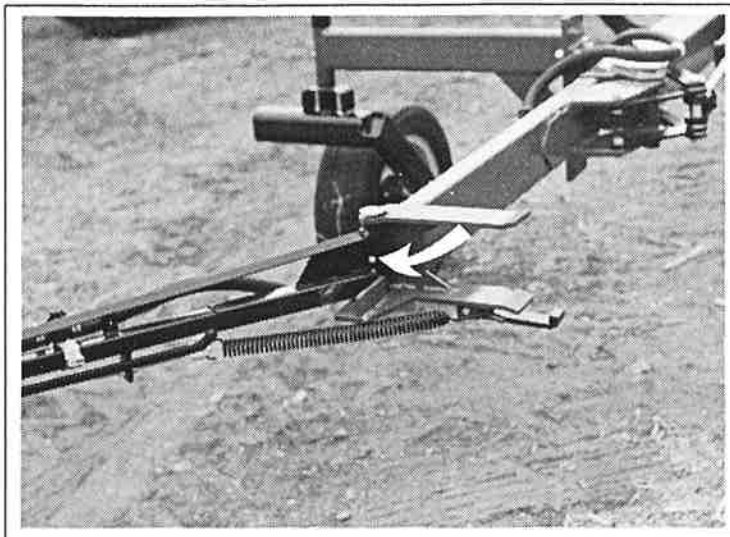
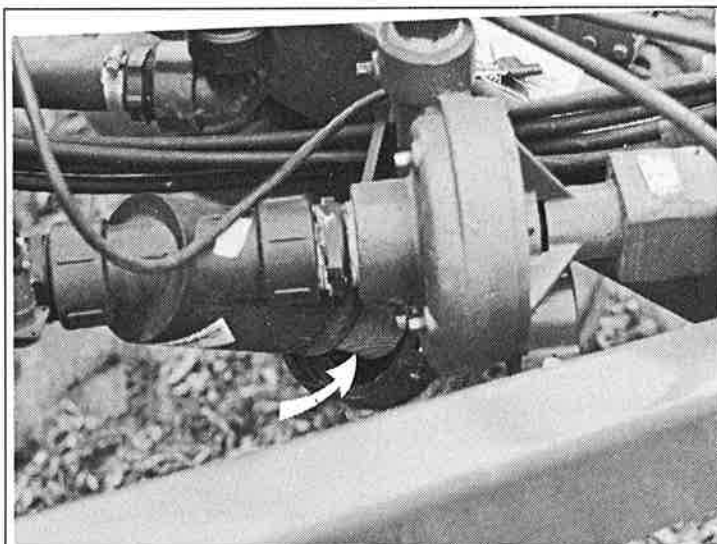
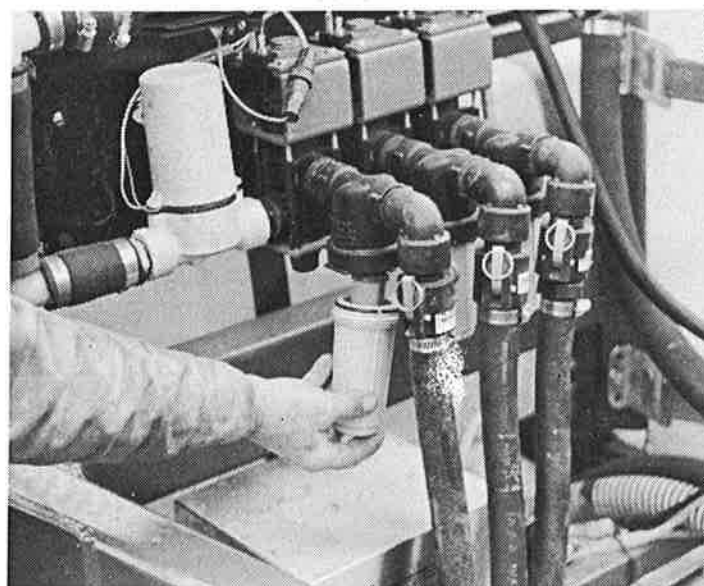

Fig. 35 BREAK - AWAY HINGE

5. Clean chemical circuit screens in the chemical circuit filters (2 locations).
 - a. Suction
 - b. Solenoids



Suction



Solenoids

Fig. 36 SCREENS

40 Hour or Weekly

1. Grease 3 point hitch (optional) rocker shaft (2 locations).

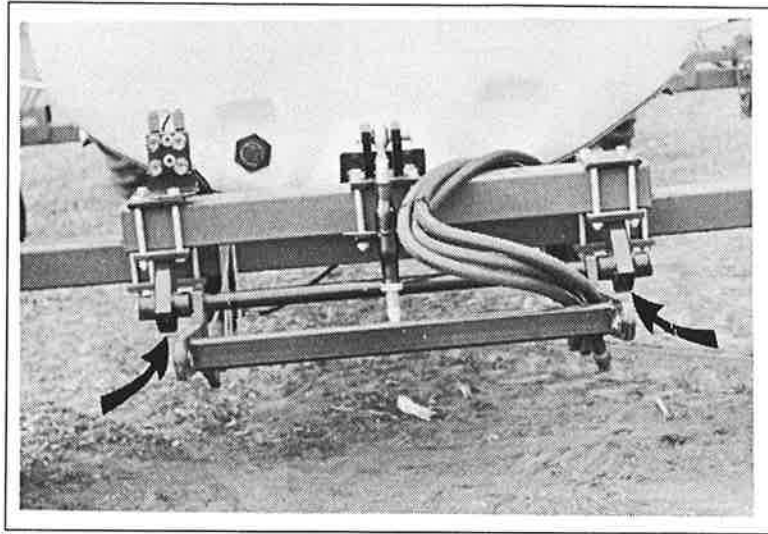

Fig. 37 3 POINT ROCKER SHAFT

Annually

1. Wash machine.
2. Repack wheel bearings.

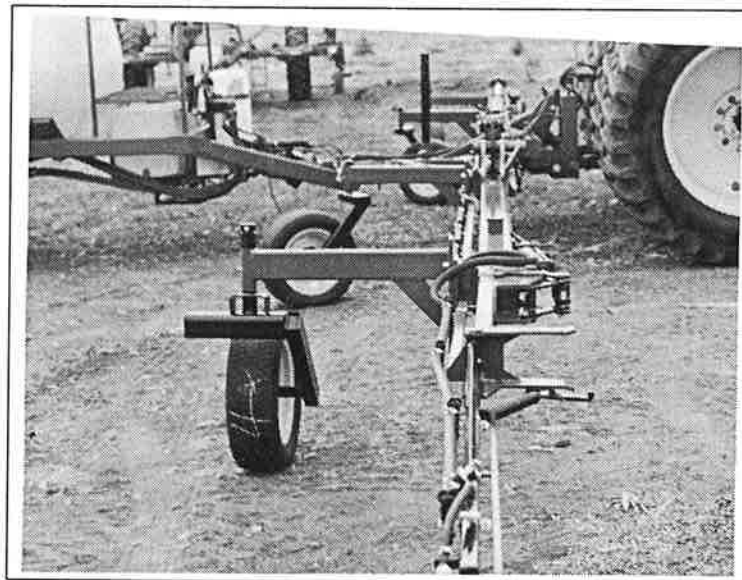

Fig. 38 WHEELS

5.1.4 SERVICE RECORD

See Lubrication and Maintenance sections for details of service. Copy this page to continue record.

ACTION CODE: CL CLEAN L LUBRICATE R REPACK

<div style="display: flex; justify-content: space-between;"> MAINTENANCE HOURS SERVICED BY </div>																			
	8 Hours or Daily																		
L First Wing Hinge (2)																			
L Second Wing Hinge (1)																			
L Wing Wheel Castor Shaft (1)																			
L Outer Wing Break-Away Hg (1)																			
CL Chemical Circuit Screens (2)																			
40 Hours or Weekly																			
L Point Hitch Rocker Shaft (2)																			
Annually																			
CL Machine																			
R Wheel Bearings																			

5.2 MAINTENANCE

5.2.1 FILTER CLEANING

The fluid in the sprayer is continually being filtered through a screen filter in the suction and boom lines. The sprayer must have clean water to prevent clogging of the nozzle screens and check valves when in use. This screen must be cleaned daily or more often as required. To clean, follow this procedure:

1. At the start of each day before the water and chemicals are added, the screen should be checked and cleaned.
2. If there is water or solution in the sprayer, close Valves 2 and 3 to isolate the screens.
3. Loosen the filter bodies by hand. Do not use a wrench as this could damage the filter body.
4. Remove the screens and inspect them for dirt.
5. Clean them using clean water.
6. Inspect for holes or tears. If there is damage, replace it.
7. Install the screens and body to the filter heads and tighten by hand. Do not overtighten and crack the head.
8. Open the ball valves to allow the solution to circulate.
9. Drain all screens before storage to avoid freezing.

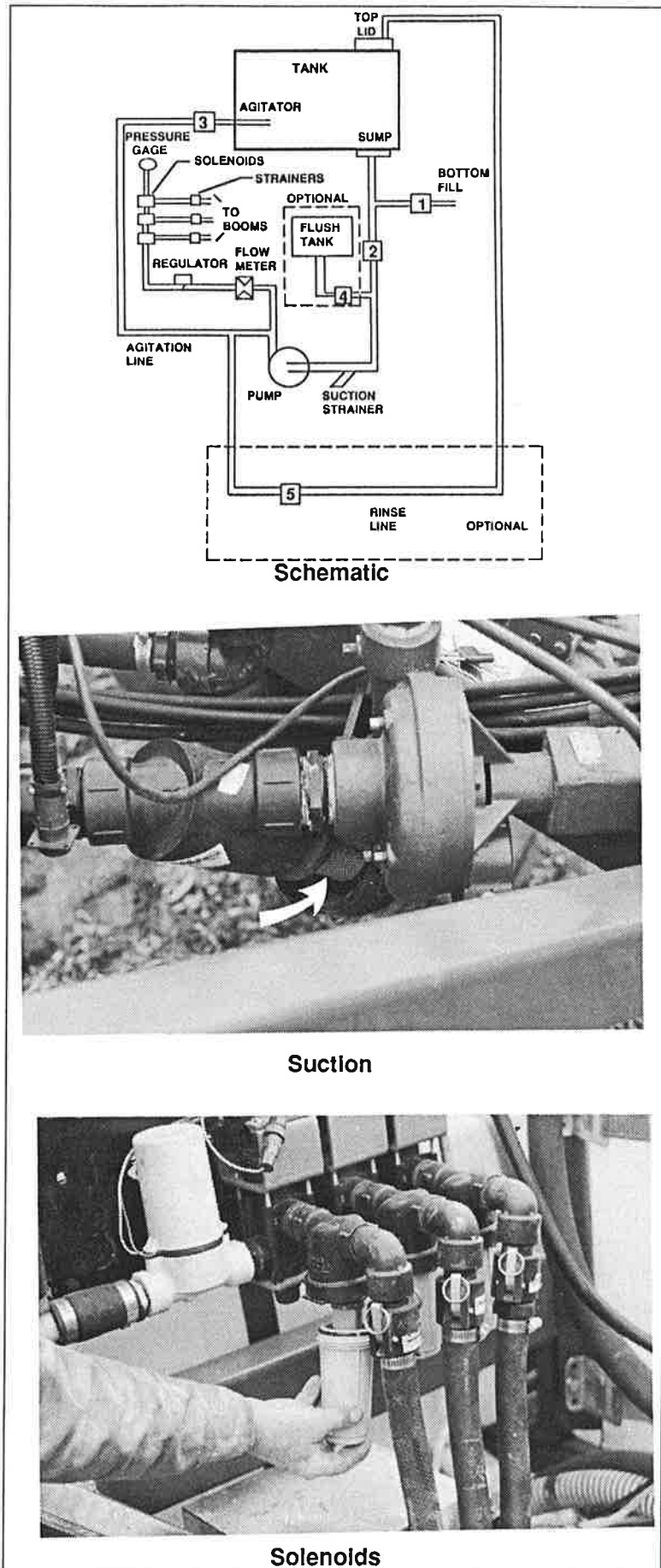

Fig. 39 SCREENS

5.2.2 TANK CLEANING

Daily Cleaning

At the end of the working day, clean the system using this procedure:

1. After the chemical solution has been completely sprayed out through the booms, add 20 gallons (75 liters) of clear water to the tank.
2. Allow the water to circulate for 5 minutes.
3. Spray the rinse lightly over previously sprayed crop.
4. Add another 20 gallons (75 liters) of clean water.
5. Add a strong detergent to the tank and run for 5 minutes.
6. Wash the inside of the tank with the wash circuit to remove all chemical residue.



WARNING

1. Do not enter tank when cleaning.
2. Reach in with a long handled mop.

7. If your sprayer is equipped with a flush tank and rinse circuit, open valve 5 and let the wash head inside the top of tank clean the inside of the main tank.
8. Flush the entire solution out of the booms to clean the hoses and plumbing.
9. Rinse system with clean water.

Changing Chemicals and Annual Wash Salt and Amine Method

1. Do the wash and rinse procedure outlined for Daily Cleaning.
2. Add 20 gallons (75 liters) of clean water to the tank.
3. Add 1/2 gallon (2 liters) of household ammonia to the tank (1 part ammonia to 100 parts water).

NOTE

A commercially available sprayer tank cleaning compound can be used instead of ammonia.

4. Circulate solution for 5 minutes.
5. Spray half solution out the booms.
6. Let the balance sit for a minimum of 8 hours.
7. Circulate solution for 10 minutes and spray out the booms.
8. Rinse the system thoroughly with clean water and flush out the booms.

5.2.3 NOZZLE/WING HEIGHT

The reference height of the frame and nozzles is set by the position of the tractor 3 point hitch. The wing wheel frames must be set so the wing/frame and nozzles are set the same height above the ground as the center section. If you need to change the nozzle/wing height, follow this procedure:

1. Clear the area of bystanders, especially small children, before starting.
2. Place all controls in neutral, stop engine, set park brake, remove ignition key and wait for all moving parts to stop before dismounting.
3. Use a pressure washer to clean the residue from the outside of the machine. Dispose of the wash water in an environmentally safe manner.
4. Wear appropriate safety gear when working on machine.
5. Wing nozzle height:

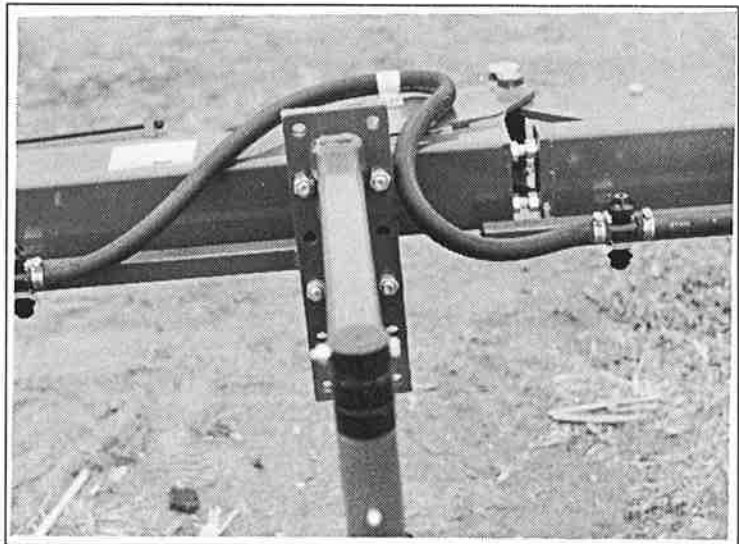

Fig. 40 WHEEL ASSEMBLY

- a. Support the wing frame with a hoist or safety stand.
- b. Remove the mounting bolts holding the wheel assembly to the frame.

NOTE

Remove castor wheel for easier handling.

- c. Set the assembly at the required position.

NOTE

Turn wheel bracket over for additional height.

- d. Tighten mounting bolts to their specified torque.
- e. Remove hoist or safety stand.
- f. Repeat procedure on the other wing wheels.

5.2.4 WING ALIGNMENT

The second wing swings forward as it moves into field configuration. It must be set so the wing frame is straight the full width of the machine. To set the wing alignment, follow this procedure:

1. Clear the area of bystanders, especially small children, before starting.
2. Place all controls in neutral, stop engine, set park brake, remove ignition key and wait for all moving parts to stop before dismounting.
3. Use a pressure washer to clean the residue from the outside of the machine. Dispose of the wash water in an environmentally safe manner.
4. Wear appropriate safety gear when working on the machine.
5. Loosen the jam nuts and turn the set screws to their new position.
6. Tighten the jam nuts to their specified torque.
7. Repeat with the other wing as required.

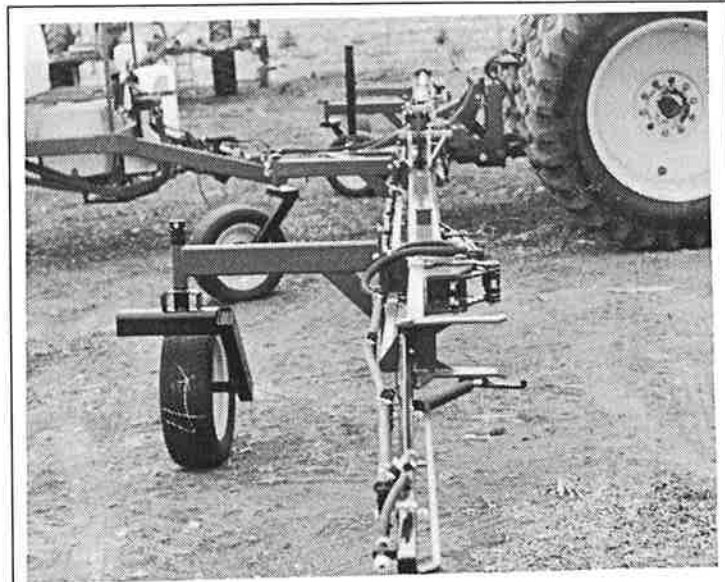

Straight

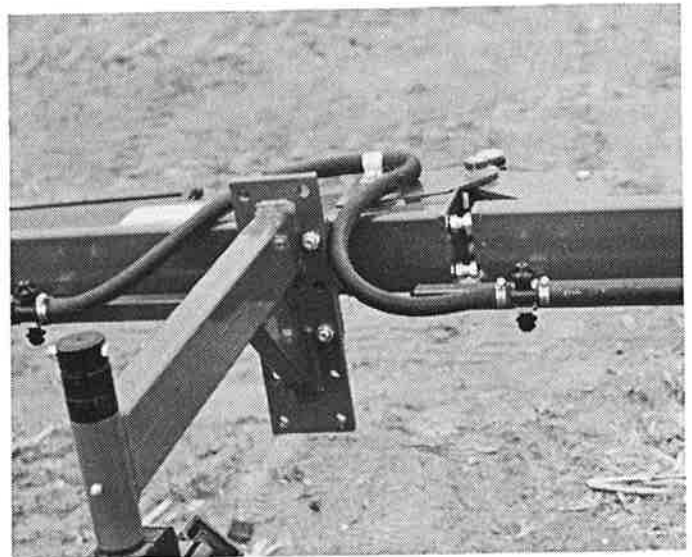

Adjustment Set Screws

Fig. 41 WING ALIGNMENT

5.2.5 CADDY 3 POINT HITCH

The caddy axle is normally located in its forward position when it comes from the factory. When the caddy is equipped with an optional 3 Point Hitch, the axle must be moved to its rear mounting position to assist in balancing the weight of the sprayer. To move the axle follow this procedure:

1. Clear the area of bystanders, especially small children, before starting.
2. Place all controls in neutral, stop engine, set park brake, remove ignition key and wait for all moving parts to stop before dismounting.
3. Use a pressure washer to clean the residue from the outside of the machine. Dispose of the wash water in an environmentally safe manner.
4. Wear appropriate safety gear when working on the machine.
5. Jack the caddy up and place safety stands under the frame.
6. Remove the U bolts that clamp the axle in position.
7. Move the axle to the new position.
8. Install the U bolts and tighten to their specified torque.
9. Remove the safety stands.
10. Install the 3 Point Hitch. Tighten mounting bolts to their specified torque.
11. Install hydraulic and chemical lines.
12. Install electrical harness.

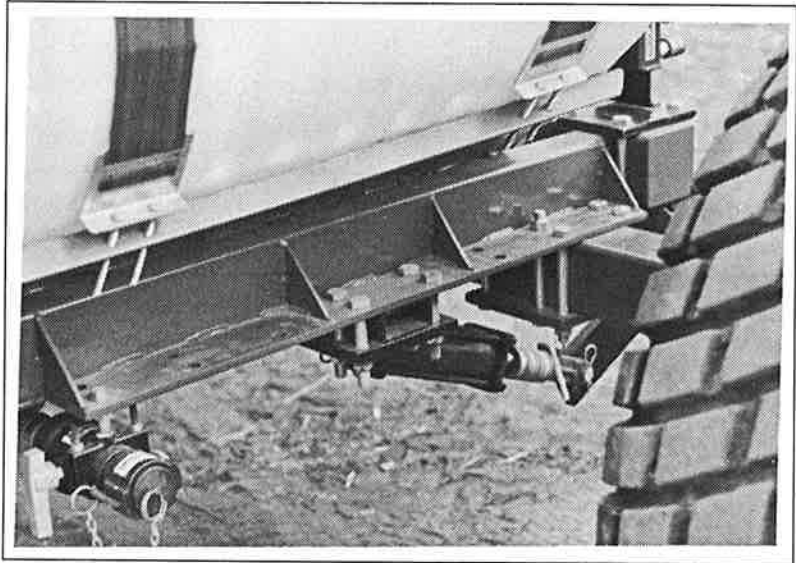

Fig. 42 AXLE (REAR MOUNT)

6 TROUBLE SHOOTING

The Fast Distributing Field Sprayer uses a pressure circuit to deliver a chemical compound in solution to a series of nozzles for application to crops. It is a simple and reliable system that requires minimal maintenance.

In the following section, we have listed many of the problems, causes and solutions to the problems that you may encounter.

If you encounter a problem that is difficult to solve, even after having read through this trouble shooting section, please call your local Fast Distributing dealer or distributor. Before you call, please have this Operator's Manual and the serial number from your machine ready.

PROBLEM	CAUSE	SOLUTION
Sprayer is not stable. Moves from side-to-side.	Low tire pressure.	Add air to tires.
	Loose wheel bolts.	Tighten wheel bolts.
	3 point sway blocks up.	Lower sway blocks.
System loses pressure.	Filter screen plugged.	Clean chemical line screens.
	Pump worn.	Check and repair or replace pump.
	Faulty suction hose.	Check for collapsed suction hose. Replace hose.
	Faulty regulator.	Replace regulator.
	Hose leaking.	Tighten hose or replace hose.
Sprayer pressure too high.	Return hose plugged.	Clean or replace hose.
	Faulty pressure sensor.	Calibrate sensor. Replace as required.
	Faulty regulator.	Repair or replace valve.
	Wrong agitation valve setting.	Open throttling valve slightly until pressure goes to required range.

PROBLEM	CAUSE	SOLUTION
Chemical system pressure too low.	Return hose plugged.	Clean or replace hose.
	Faulty pressure sensor.	Calibrate sensor. Replace as required.
	Faulty regulator.	Repair or replace valve.
	Wrong agitation valve setting.	Close agitation valve slightly until pressure goes to required range.
Check valves or screens plugging.	Dirty water.	Flush and clean the system. Use clean water.
	Poorly mixed chemicals.	Mix chemicals slower. Follow mixing instructions.
High spray drift.	Nozzles set too high.	Lower nozzles
	Too windy.	Wait until wind dies down.
The pump does not draw water.	Pump is airlocked.	Bleed air from pump.
	Suction line is plugged or collapsed.	Examine suction line. Replace as required.
	Pump faulty.	Replace pump.
Pressure reading fluctuates.	The pump is sucking in air through the intake or air has not been entirely evacuated from the pump.	Examine the suction hose and make sure it is firmly secured. Run the pump with the outlet hose open to evacuate air from pump.
	Regulator broken.	Replace regulator.
The spray flow is irregular.	Filter screen plugged.	Clean screens.
	Nozzle screens plugged.	Clean nozzle screens.

PROBLEM

CAUSE

SOLUTION

Can't develop enough pressure.

Broken pressure regulator.

Replace pressure regulator.

Worn pump.

Repair or replace pump.

Leaking hose or fitting.

Replace hose or tighten fitting.

Pump running too slow.

Increase pump speed.

Wrong agitation valve setting.

Close agitation valve slightly until pressure goes to required range.

No pressure reading.

Defective controller gauge.

Replace gauge.

Spray won't shut off.

Defective switch in monitor.

Replace switch.

Solenoid valve doesn't close.

Magnet stuck. Spring broken.
Replace defective parts.

Controller doesn't control sprayer.

Blown fuse.

Replace fuse.

Poor connection.

Pull connections apart. Clean terminals. Reconnect.

No power.

Connect power wire.

Refer to Controller manual.

Refer to Controller manual.

Wings bouncing.

Traveling too fast.

Slow down.

7 OPTIONS

7.1 FOAM MARKER

This tank and control are mounted on the caddy frame and in the cab respectively. It is used to mark the field as it is sprayed.

Fill at the start of each day and during the day as the fluid is used.

7.2 FLUSH TANK

This tank is mounted on the front of the frame and is plumbed into the suction line between the main tank and the pump. If you want to flush out the pump, lines and nozzles for maintenance work, shut off the ball valve in the main suction line and open the valve to the flush tank. Run the pump to flush the active solution out the nozzles.

The flush tank system also includes a wash head that is plumbed into the top lid for rinsing or washing the main tank.

7.3 CHEMICAL CIRCUIT CONTROLLER

An automatic spray controller or manual controller is available for use with the sprayer. The sprayer works well with either controller.

7.4 CADDY 3 POINT HITCH

A 3 Point Hitch is available that fits on the back of the caddy frame. This allows the sprayer to be mounted on the back of the caddy.

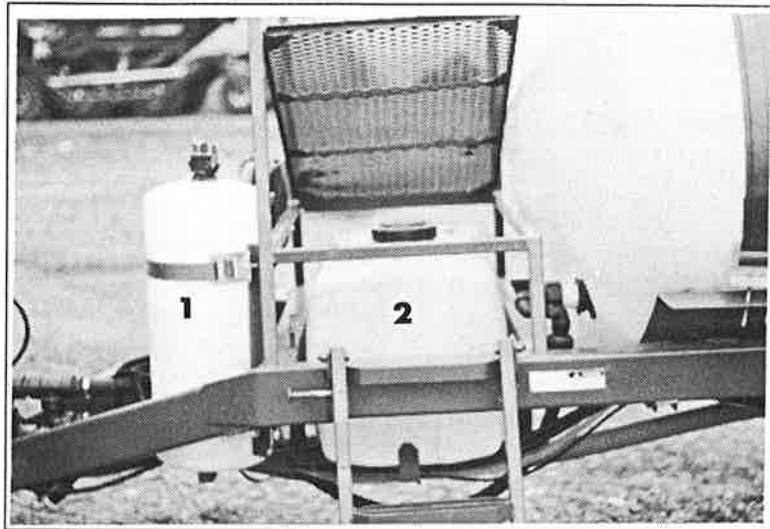

Fig. 43 OPTIONAL EQUIPMENT



Fig. 44 AUTOMATIC CONTROLLER

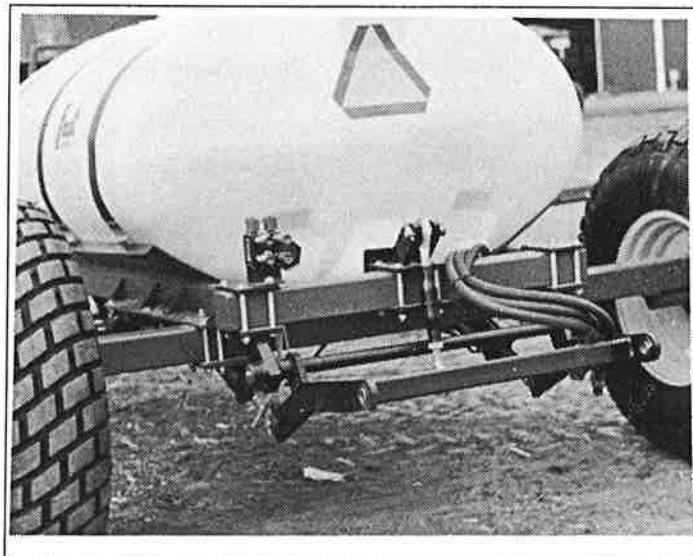

Fig. 45 CADDY 3 POINT HITCH

8 SPECIFICATIONS

8.1 MECHANICAL

DIMENSIONS		4515	6015	6020
Length:	Field: Transport:	20 ft (6.10 m) 20 ft (6.10 m)	20 ft (6.10 m) 20 ft (6.10 m)	20 ft (6.10 m) 20 ft (6.10 m)
Width:	Field: Transport:	45 ft. (13.72 m) 15 ft. (4.57 m)	60 ft. (18.29 m) 15 ft. (4.57 m)	60 ft. (18.29 m) 20 ft. (6.10 m)
Height:	Transport: Folding:	7 ft. (2.13 m) 18 ft (5.49 m)	7 ft. (2.13 m) 16 ft (4.88 m)	7 ft. (2.13 m) 22 ft (6.71 m)
Weight:	Spray Bar: Caddy:	1750 lbs. (800 kg) 1750 lbs (800 Kg) 1000 gal	2100 lbs. (950 kg) 1750 lbs (800 Kg) 1000 gal	1920 lbs. (875 kg) 1750 lbs (800 Kg) 1000 gal
Tank Capacity:		500,750, 1000 & 1600 gal (1875, 2800, 3750 & 6000 l)	500, 750, 1000 & 1600 gal (1875, 2800, 3750 & 6000 l)	500, 750, 1000 & 1600 gal (1875, 2800, 3750 & 6000 l)
Boom Height:		Adjustable 16-35 inches (406-890 mm)	Adjustable 16-35 inches (406-890 mm)	Adjustable 16-35 inches (406-890 mm)
PUMP (Optional)				
	Hydraulically driven: (Input)	8 gpm @ 500 psi 30 lpm @ 3445 kPa	8 gpm @ 500 psi 30 lpm @ 3445 kPa	8 gpm @ 500 psi 30 lpm @ 3445 kPa
	Performance: (Output)	70 gpm @ 40 psi 260 lpm @ 275 kPa	70 gpm @ 40 psi 260 lpm @ 275 kPa	70 gpm @ 40 psi 260 lpm @ 275 kPa
	Tank Agitators:	Sparger tube	Sparger tube	Sparger tube
TIRES				
	Caddy:	16.9 x 24 24 psi (165 kPa)	16.9 x 24 24 psi (165 kPa)	16.9 x 24 24 psi (165 kPa)
	Wings:	1.85 x 14	1.85 x 14	1.85 x 14
CONTROLLERS				
	Power:	12 volts, 10 amp	12 volts, 10 amp	12 volts, 10 amp

SPECIFICATIONS SUBJECT TO CHANGE WITHOUT NOTICE

8.1 MECHANICAL (cond't)

DIMENSIONS		7220	8020	9020
Length:	Field: Transport:	20 ft (6.10 m) 20 ft (6.10 m)	20 ft (6.10 m) 20 ft (6.10 m)	20 ft (6.10 m) 20 ft (6.10 m)
Width:	Field: Transport:	72 ft. (21.95 m) 20 ft. (6.10 m)	80 ft. (24.38 m) 20 ft. (6.10 m)	90 ft. (27.32 m) 20 ft. (6.10 m)
Height:	Transport: Folding:	7 ft. (2.13 m) 20 ft (6.10 m)	7 ft. (2.13 m) 21 ft (6.40 m)	7 ft. (2.13 m) 21 ft (6.40 m)
Weight:	Spray Bar: Caddy:	2300 lbs. (1050 kg) 1750 lbs (800 Kg) 1,000 gal	2350 lbs. (1070 kg) 1750 lbs (800 Kg) 1,000 gal	2400 lbs. (1090 kg) 1750 lbs (800 Kg) 1,000 gal
Tank Capacity:		500,750, 1000 & 1600 gal (1875, 2800, 3750 & 6000 l)	500, 750, 1000 & 1600 gal (1875, 2800, 3750 & 6000 l)	500, 750, 1000 & 1600 gal (1875, 2800, 3750 & 6000 l)
Boom Height:		Adjustable 16-35 inches (406-890 mm)	Adjustable 16-35 inches (406-890 mm)	Adjustable 16-35 inches (406-890 mm)
PUMP (Optional)				
	Hydraulically driven: (Input)	8 gpm @ 500 psi 30 lpm @ 3445 kPa	8 gpm @ 500 psi 30 lpm @ 3445 kPa	8 gpm @ 500 psi 30 lpm @ 3445 kPa
	Performance: (Output)	140 gpm @ 40 psi 525 lpm @ 275 kPa	140 gpm @ 40 psi 525 lpm @ 275 kPa	140 gpm @ 40 psi 525 lpm @ 275 kPa
	Tank Agitators:	Sparger tube	Sparger tube	Sparger tube
TIRES				
	Caddy:	16.9 x 24 24 psi (165 kPa)	16.9 x 24 24 psi (165 kPa)	16.9 x 24 24 psi (165 kPa)
	Wings:	1.85 x 14	1.85 x 14	1.85 x 14
CONTROLLERS				
	Power:	12 volts, 10 amp	12 volts, 10 amp	12 volts, 10 amp

SPECIFICATIONS SUBJECT TO CHANGE WITHOUT NOTICE

8.2 BOLT TORQUE

CHECKING BOLT TORQUE

The tables shown below give correct torque values for various bolts and capscrews. Tighten all bolts to the torques specified in chart unless otherwise noted. Check tightness of bolts periodically, using bolt torque chart as a guide. Replace hardware with the same strength bolt.

ENGLISH TORQUE SPECIFICATIONS

Bolt Diameter "A"	SAE 2		SAE 5		SAE 8	
	N.m	(lb-ft)	N.m	(lb-ft)	N.m	(lb-ft)
1/4"	8	(6)	12	(9)	17	(12)
5/16"	13	(10)	25	(19)	36	(27)
3/8"	27	(20)	45	(33)	63	(45)
7/16"	41	(30)	72	(53)	100	(75)
1/2"	61	(45)	110	(80)	155	(115)
9/16"	95	(70)	155	(115)	220	(165)
5/8"	128	(95)	215	(160)	305	(220)
3/4"	225	(165)	390	(290)	540	(400)
7/8"	230	(170)	570	(420)	880	(650)
1"	345	(225)	850	(630)	1320	(970)

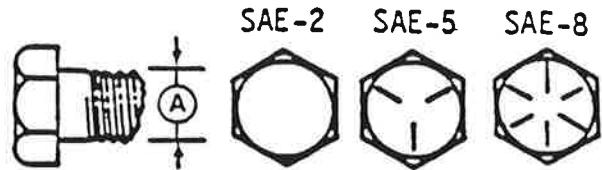

Torque figures indicated above are valid for non-greased or non-oiled threads and heads unless otherwise specified. Therefore, do not grease or oil bolts or capscrews unless otherwise specified in this manual. When using locking elements, increase torque values by 5%.

* Torque value for bolts and capscrews are identified by their head markings.

8.3 HYDRAULIC FITTING TORQUE

TIGHTENING FLARE TYPE TUBE FITTINGS *

1. Check flare and flare seat for defects that might cause leakage.
2. Align tube with fitting before tightening.
3. Lubricate connection and hand tighten swivel nut until snug.
4. To prevent twisting the tube(s), use two wrenches. Place one wrench on the connector body and with the second tighten the swivel nut to the torque shown.

* The torque values shown are based on lubricated connections as in reassembly.

Tube Size OD (in.)	Nut Size Across Flats (in.)	Torque Value*		Recommended Turns to Tighten (After Finger Tightening)	
		(N.m)	(lb-ft)	(Flats)	(Turns)
3/16	7/16	8	6	1	1/6
1/4	9/16	12	9	1	1/6
5/16	5/8	16	12	1	1/6
3/8	11/16	24	18	1	1/6
1/2	7/8	46	34	1	1/6
5/8	1	62	46	1	1/6
3/4	1-1/4	102	75	3/4	1/8
7/8	1-3/8	122	90	3/4	1/8

8.4 CHEMICAL CIRCUIT SCHEMATIC

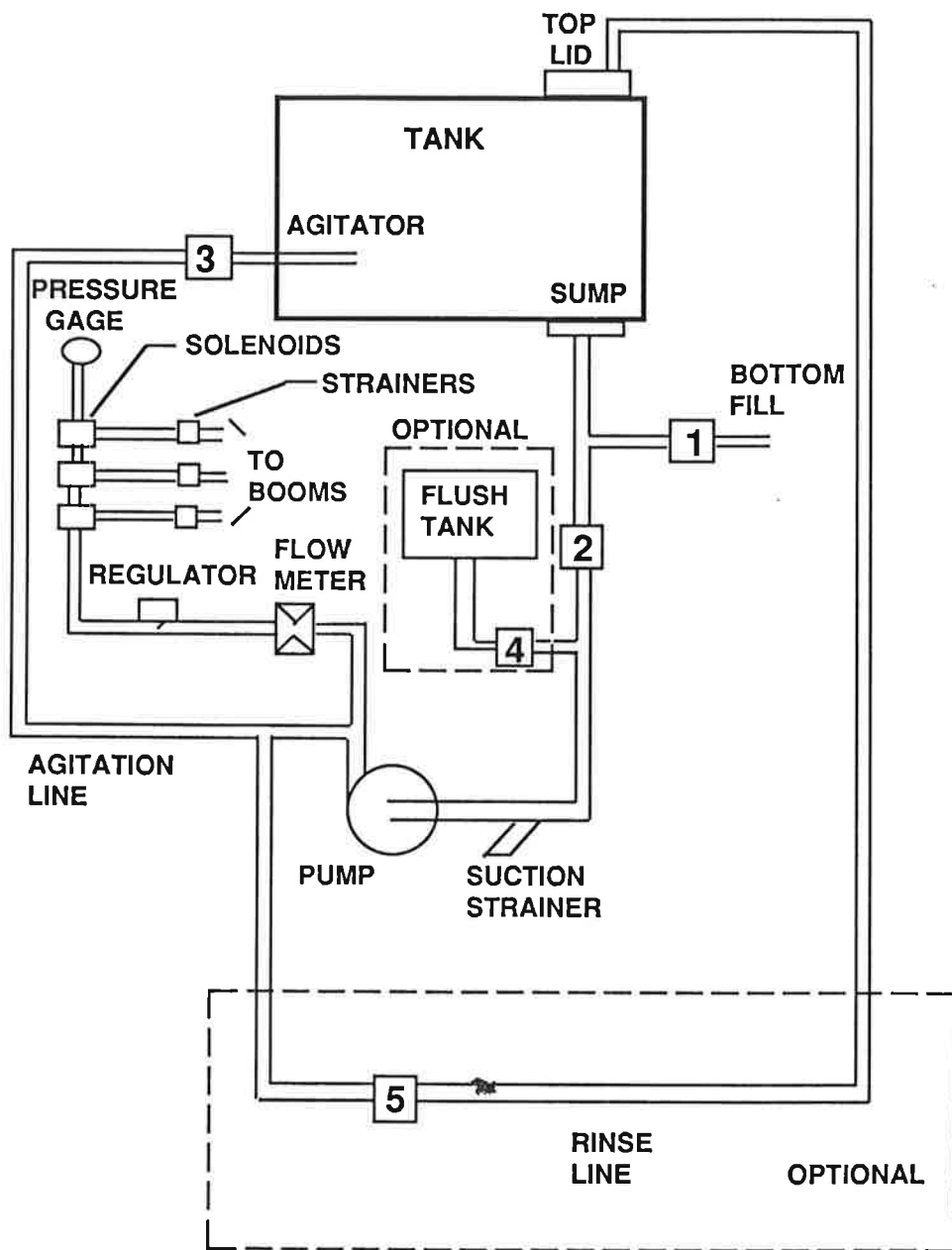

9 INDEX

I		PAGE	PAGE
Introduction	1		
 O			
Operation	12		
Attaching/Unhooking Tractor	21		
Break-In	14		
Controls	16		
Caddy Ahead of Sprayer	24		
Equipment Matching	15		
Field Operation	32		
Transport/Field Conversion	41		
Installing Controllers	20		
Machine Components	13		
Pre-Operation Checklist	14		
Sprayer Ahead Of Caddy	21		
Sprayer Calibration	26		
Area Covered	31		
Controller Calibration	27		
Engine RPM	26		
Field Calibration	31		
Ground Speed Calibration	29		
Machine Yard Calibration	29		
Nozzle Calibration	27		
Storage	43		
Placing In Storage	43		
Removing From Storage	44		
To The New Owner or Operator	12		
Transport	42		
 S			
Safety	2		
Chemical Safety	5		
General Safety	3		
Hydraulic Safety	6		
Maintenance Safety	6		
Operating Safety	4		
Safety Decals	7		
Sign-Off Form	8		
Storage Safety	7		
Tire Safety	6		
Transport Safety	7		
Safety Decal Locations	9		
Service and Maintenance	45		
Maintenance	50		
Caddy 3 Point Hitch	54		
Filter Cleaning	50		
Nozzle/Wing Height	52		
Tank Cleaning	51		
Wing Alignment	53		
Service	45		
Fluids and Lubricants	45		
Greasing	45		
Service Record	49		
Servicing Intervals	46		
Specifications	59		
Bolt Torque	61		
Chemical Circuit Schematic	62		
Hydraulic Fitting Torque	61		
Mechanical	59		
Options	58		
Foam Markers	58		
Flush Tank	58		
Chemical Circuit Controller	58		
Caddy 3 Point Hitch	58		
 T			
Trouble Shooting	55		



FAST DISTRIBUTING INC.
RT. 2, BOX 325
MOUNTAIN LAKE, MN 56159
PHONE (507) 427-3861
FAX (507) 427-3030

PRINTED IN USA
ISSUE DATE: DECEMBER, 1993

PART NUMBER: 950